

Ford Fiesta 12/2012-

Partnr.: FR-059-DH

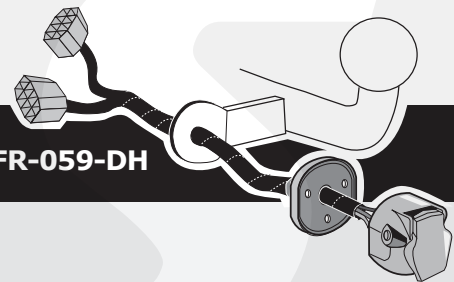

DE Einbauanleitung Elektrosatz Anhängervorrichtung mit 13-P Steckdose lt. DIN/ISO Norm 11446

FR Instructions de montage du faisceau électrique pour crochet d'attelage conforme à la norme DIN/ISO 11446 prise 13-V.

NL Montage-handleiding elektrokabelset voor trekhaak met 13-P contactdoos vlg. DIN/ISO norm 11446.

GB Fitting instructions electric wiring kit tow bar with 13-P socket up to DIN/ISO Norm 11446.

ES Instrucciones de montaje de kit eléctrico para engancho de remolque con caja de conexiones 13-P según norma DIN/ISO 11446.

IT Istruzioni di montaggio di set di cavi elettrici per gancio da traino con zoccolo a 13-P conforme alla norma DIN/ISO 11446.

SE Monteringsanvisningar elkabelsats för dragkrok med 13-P kontaktdosa enligt DIN/ISO norm 11446.

CZ Montážní pokyny: souprava pro elektrické propojení tažné tyče s 13-P zásuvkou do normy DIN/ISO 11446.

DK Monteringsvejledninger for det elektriske ledningsføringssæt for trækstang med 13-N stikdåse, DIN/ISO, norm 11446.

FI Ohjeet vetokoukun sähkökaapelisarjan asentamiseen, jossa on DIN/ISO 11446 mukainen 13-N liitin.

GR Οδηγίες συναρμολόγησης ηλεκτρικού σετ καλωδίων μπάρας ρυμούλκησης με υποδοχή 13-P μέχρι DIN/ISO Κανόνας 11446.

NO Monteringsanviser elkabelsett for trekrok med 13-P koblingsboks ifølge DIN/ISO norm 11446.

PL Instrukcje montażu zestawu okablowania elektrycznego dyszla holowniczego z 13-stykowym gniazdem DIN/ISO 11446.

DE - Wir weisen ausdrücklich darauf hin, dass eine unsachgemäße und nicht in einer Fachwerkstatt durchgeführte Montage einen Verzicht auf Entschädigung jeglicher Art insbesondere bezüglich des Produkthaftpflichtrechts zur Folge hat

FR - Il est expressément prévu qu' on ne saurait se prévaloir d'un quelconque préjudice contractuel ou réhibitoire si le montage avait été fait en dépit des dites instructions ou dans un garage ne disposant pas des équipements adéquats.

NL - Wij wijzen er met nadruk op, dat ondeskundige en niet door een vakkundige werkplaats uitgevoerde montage tot gevolg heeft dat daardoor ieder recht op schadevergoeding, ook op wettelijke aansprakelijkheid inzake producten, vervalt.

GB - We would expressly point out that assembly not carried out properly by a competent installer will result in cancellation of any right to damage compensation, in particular those arising by virtue of the product liability act.

ES - El montaje inapropiado y efectuado por personal no cualificado originará la pérdida de todo derecho a indemnización o la expiración de toda responsabilidad civil con respecto al producto.

IT - Sottolineiamo espressamente che un montaggio inadeguato ed eseguito da un'officina non specializzata ha come conseguenza il decadere di qualsiasi diritto al risarcimento danni, nonché alla responsabilità legale relativa ai prodotti.

SE - Vi påpekar med eftertryck att all rätt till skadeersättning och all laglig ansvarighet förfaller om monteringen inte har utförts på rätt sätt och av en professionell verkstad.

CZ - Výslovně zdůrazňujeme, že jakákoli montáž, která není provedená ve specializované dílně, má za následek odvolání nároků na kompenzaci jakéhokoliv druhu, obzvláště vyplývajících ze zákona o odpovědnosti za způsobené škody.

DK - Vi ønsker at gøre udtrykkeligt opmærksom på at forkert samling, der ikke er udført af et specialiseret værksted, resulterer i bortfaldelse af kompenseringskrav af alle slags, i særdeles krav der måtte opstå omkring det lovpligtige ansvar.

FI - Korostamme, että kaikki oikeudet vahinkokorvaukseen kuten myös valmistajan laillinen vastuu raukeavatt, mikäli asennusta ei ole toteutettu oikealla tavalla eikä ammattitaitoisen asiantuntijan toimesta.

GR - Επισημαίνουμε κατηγορηματικά ότι οποιαδήποτε εσφαλμένη συναρμολόγηση, η οποία δεν έχει πραγματοποιηθεί ειδικό εργαστήριο θα οδηγήσει σε απονομή των αξιώσεων επιβόλης αποζημιώσεων οποιαδήποτε είδους, ειδικά όσα προκύπτουν από το νόμο ευθύνης προϊόντων.

NO - Vi påpeker ettertrykkelig at all rett til skadeerstatning og rettslig ansvar forfaller dersom monteringen ikke er blitt utført på riktig måte og av et profesjonelt verksted.

PL - Chcielibyśmy wyraźnie zaznaczyć, iż wszelki nieprawidłowy montaż, który nie jest wykonywany w specjalistycznym warsztacie pociąga za sobą utratę możliwości dochodzenia wszelkiego typu roszczeń, w szczególności tych wynikających z odpowiedzialności producenta za swój produkt.

- Technische Änderungen vorbehalten.
- Widerstand nur gemäß der Tabelle auf dem Anhänger verwenden.

- Sous réserve de modifications techniques.
- Ne excédez pas la charge maximale, indiquée dans le tableau.

- Technische wijzigingen voorbehouden.
- Gebruik alleen belasting volgens aansluittabel op het getrokken voertuig.

- Contents of these kits and their fitting manuals are subject to alteration without notice, please ensure that these instructions are read and fully understood before commencing installation.

- Do not overload circuits; the maximum loads per connection are detailed in this manual.

- Nos reservamos el derecho a efectuar modificaciones técnicas.

- Utilice sólo cargas de acuerdo a la tabla de conexión del vehículo remolcado.

- Ci si riserva il diritto di apportare modifiche tecniche.

- Utilizzare esclusivamente un carico conforme alla tabella degli allacci relativa al veicolo in questione.

- Tekniska ändringar förbehålles.

- Använd endast belastning enligt anslutningstabellen på det dragna fordonet.

- Změny mohou být provedeny bez oznámení.

- Používejte pouze při maximálním nabití podle tabulky na tažném vozidle.

- Kan ændres uden varsel.

- Brug kun den maksimale belastning, i overensstemmelse med forbindelsestabelen for bugserede køretøjer.

- Oikeus teknisiin muutoksiin ilman erillistä huomautusta pidätetään.

- Kuormita työvirtapiiriä ainoastaan hinattavan ajoneuvon kytkentäkaavion mukaisesti.

- Μπορεί να τροποποιηθεί χωρίς προηγούμενη ειδοποίηση.

- Χρησιμοποιείτε μόνο μέγιστο ηλεκτρικό φορτίο σύμφωνα με τον πίνακα σύνδεσης στο ρυμούλκούμενο όχημα.

- Tekniske endringer forbeholdes. - Overskrid ikke grensene anviset i tilkoblingstabellen på tilhengeren eller det tilkoblede kjøretøyet.

- Podlega zmianom bez powiadomienia.

- Używać tylko takiego maksymalnego obciążenia które wynika z tabliczki połączeń holowanego pojazdu.

DE

FR

NL

GB

ES

IT

SE

CZ

DK

FI

GR

NO

PL

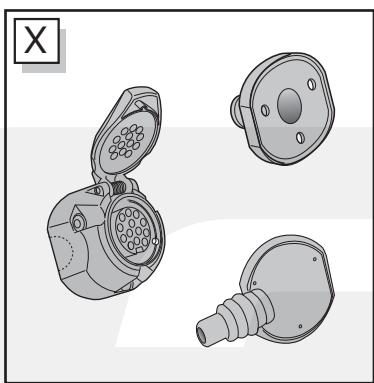
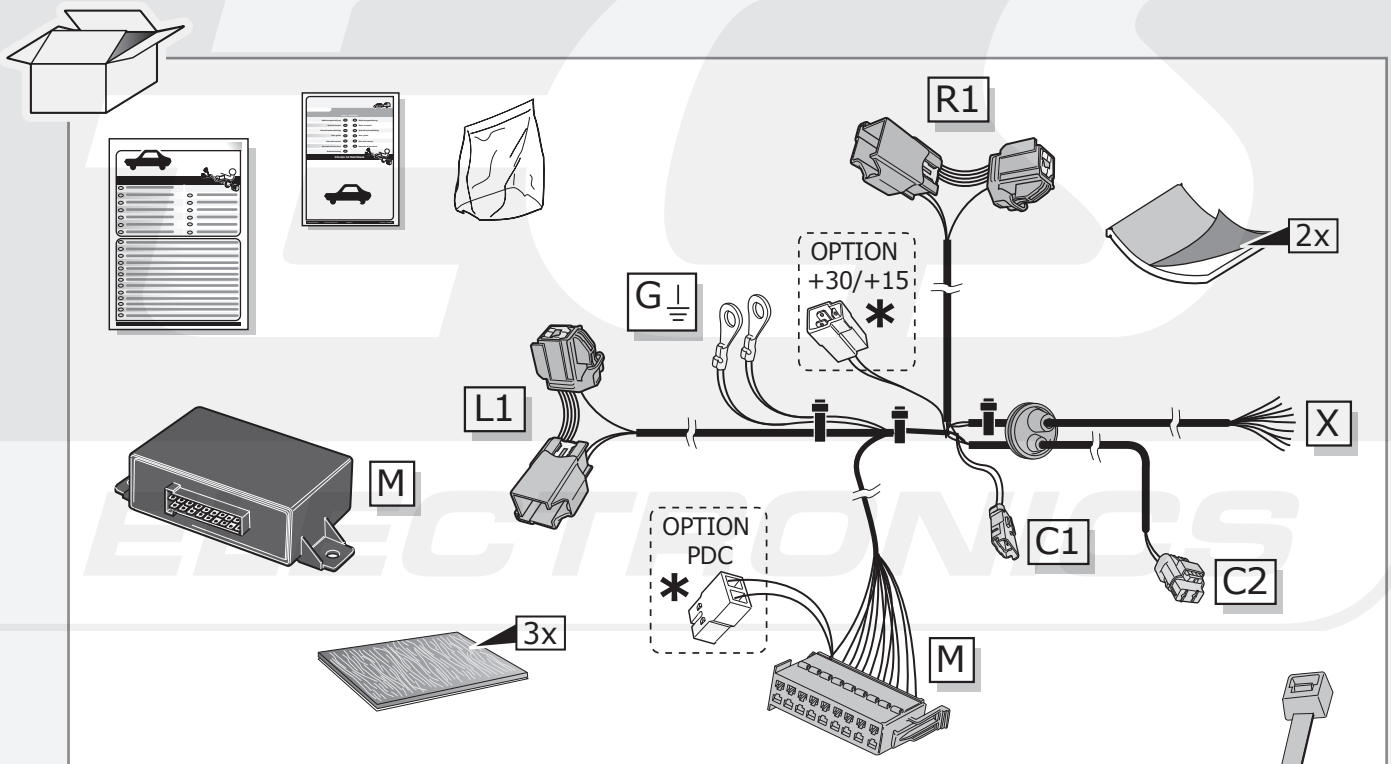

*** OPTION +30/+15**
 vorbereitung für
 préparation pour
 voorbereiding voor
 preparación para
 preparazione per
 förberedelse för
 příprava pro
 forberedelse for
 valmistelu varten
 Προετοιμασία για
 forberedelse på
 przygotowanie do

	DE Braun/Weiß	CZ Hnědo/Bílá
	FR Marron/Blanc	DK Brun/Hvid
	NL Bruin/Wit	FI Ruskea/Valkoinen
	GB Brown/White	GR Καφέ/Λευκό
	ES Marrón/Blanco	NO Brun/Hvit
	IT Marrone/Bianco	PL Brązowy/Biały
	SE Brun/Vit	
	DE Rot	CZ Červená
	FR Rouge	DK Rød
	NL Rood	FI Punainen
	GB Red	GR Κόκκινο
	ES Rojo	NO Rød
	IT Rosso	PL Czerwony
	SE Röd	

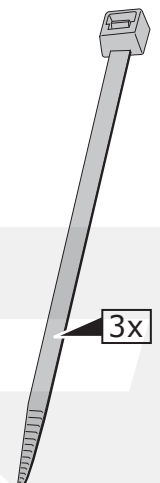

*** OPTION P.D.C.**

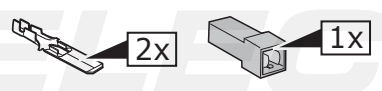
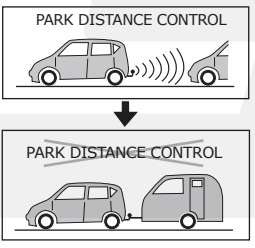

→ **Pag. 9**

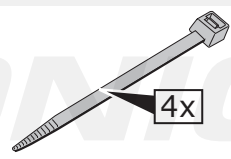

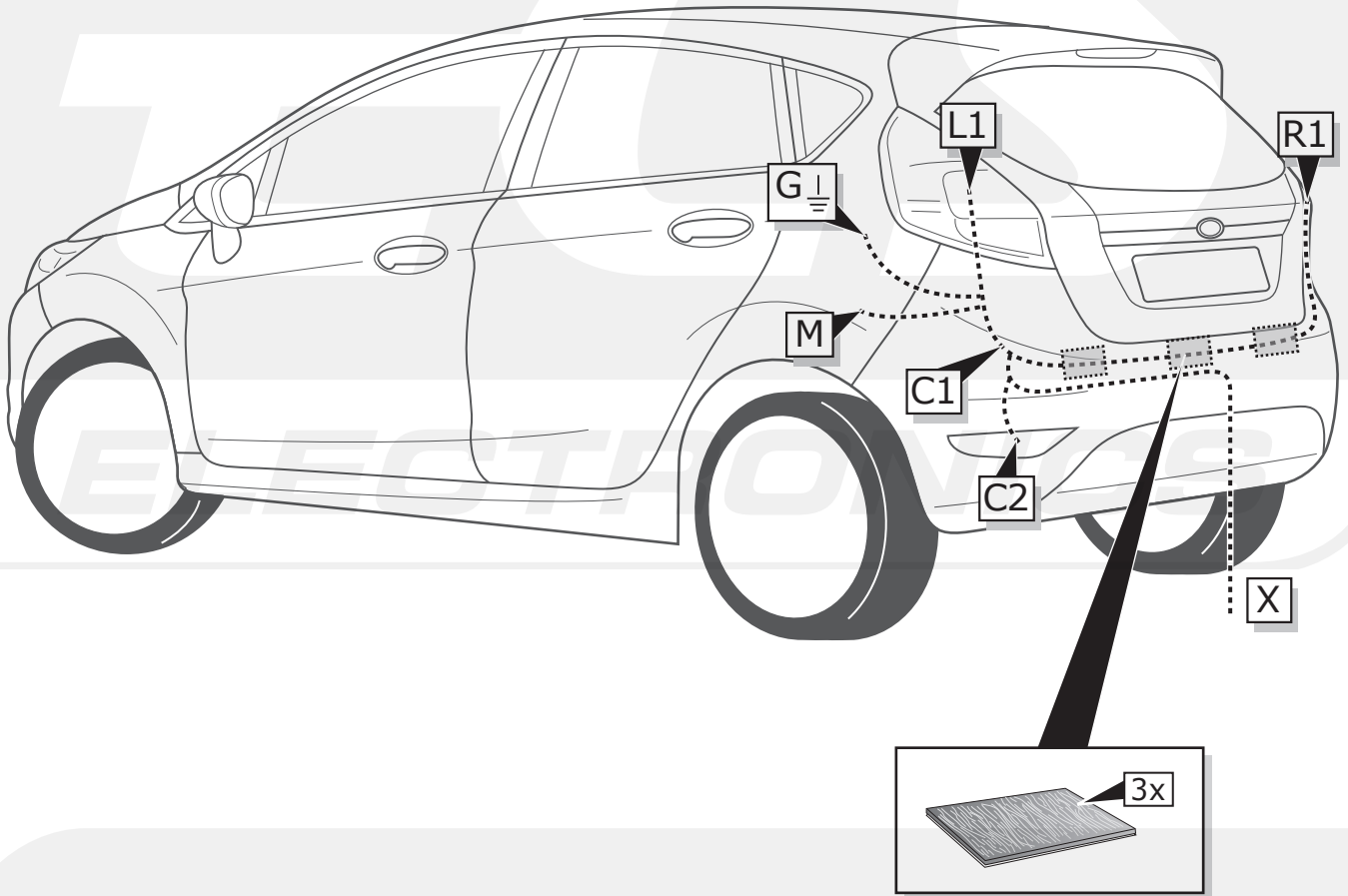

1

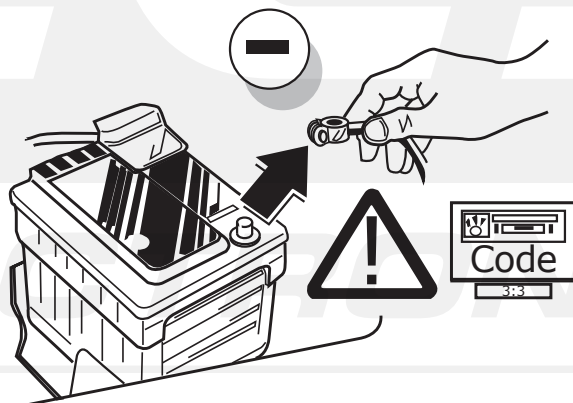

2

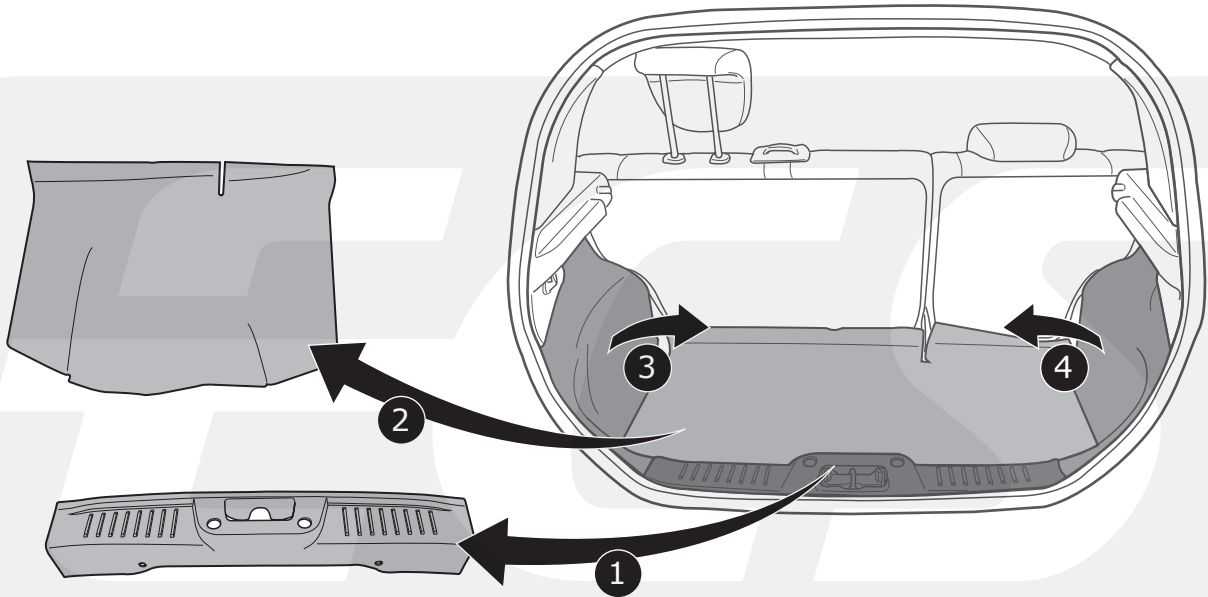

3

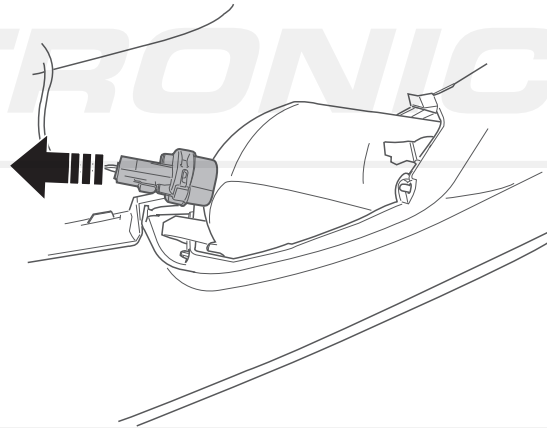
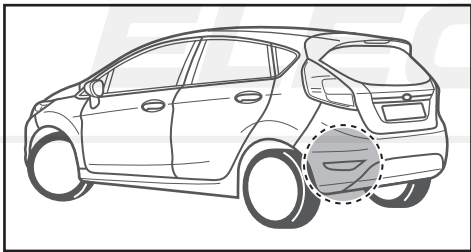

4

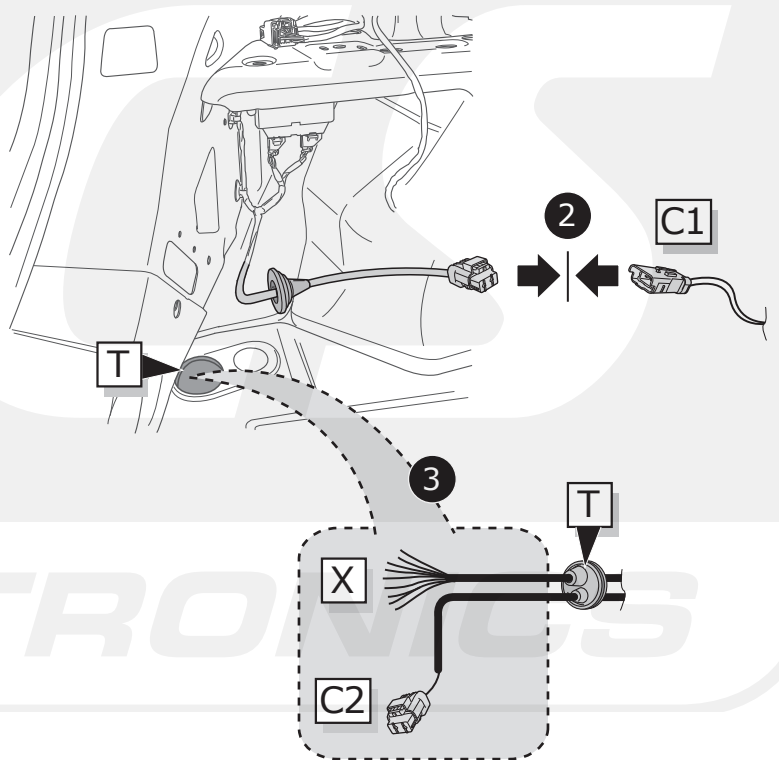
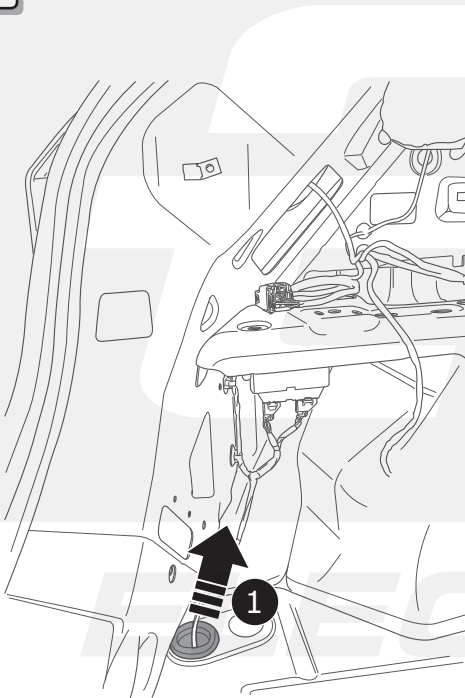

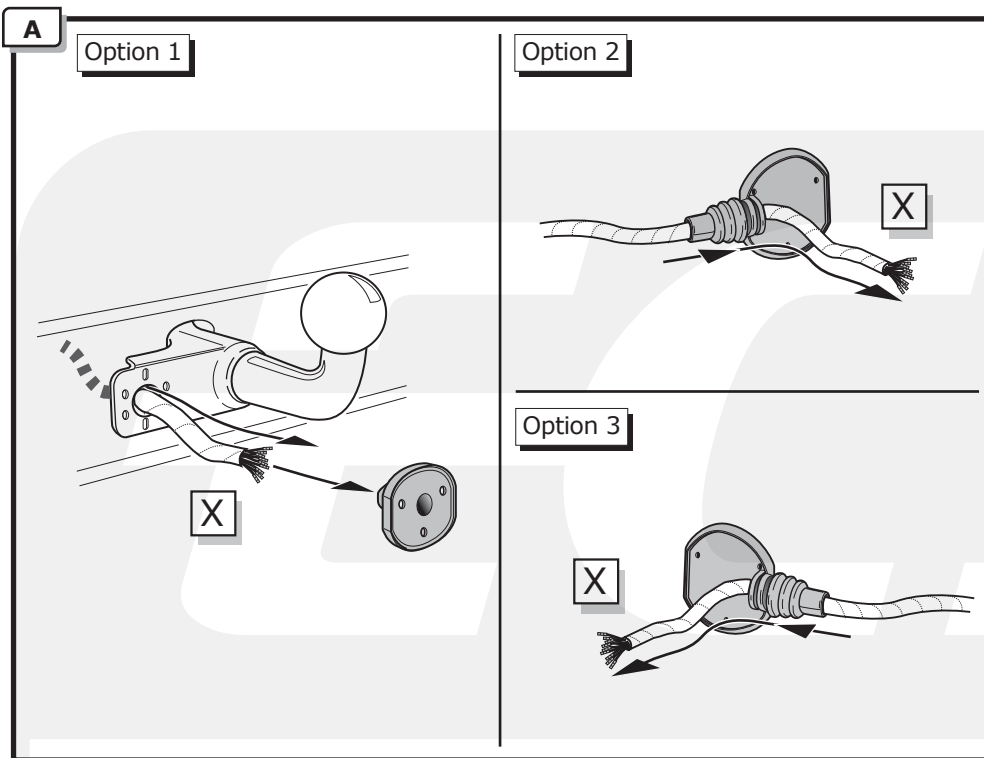

INFO

- (DE) Anschluss Steckdose
- (FR) Connection de la prise
- (NL) Contactdoos aansluiting
- (GB) Socket connection
- (ES) Conexión de la caja de enchufe
- (IT) Allaccio zoccolo
- (SE) Anslutning kontaktdosa
- (CZ) Objímkový konektor
- (DK) Stikdåse forbindelse
- (FI) Pistorasia liitäntä
- (GR) Υποδοχή σύνδεσης
- (NO) Tilkobling koblingsboks
- (PL) Połączenie przez gniazdo

Pag. 10

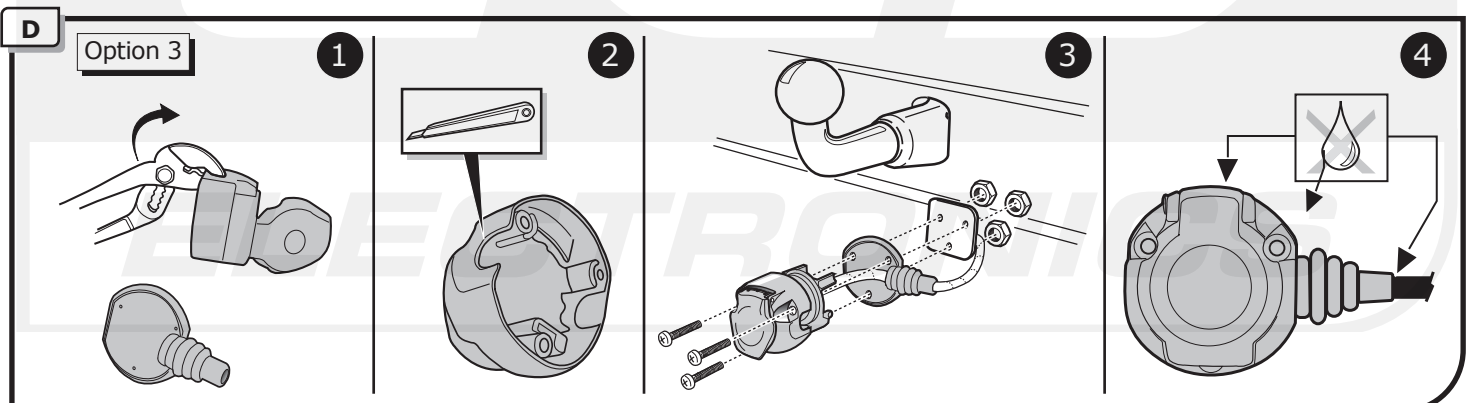
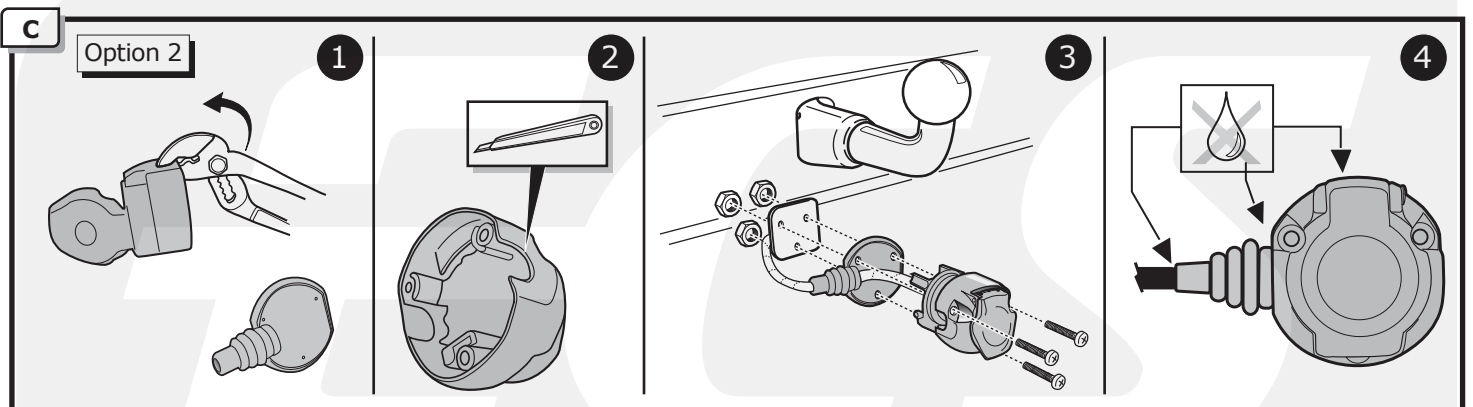
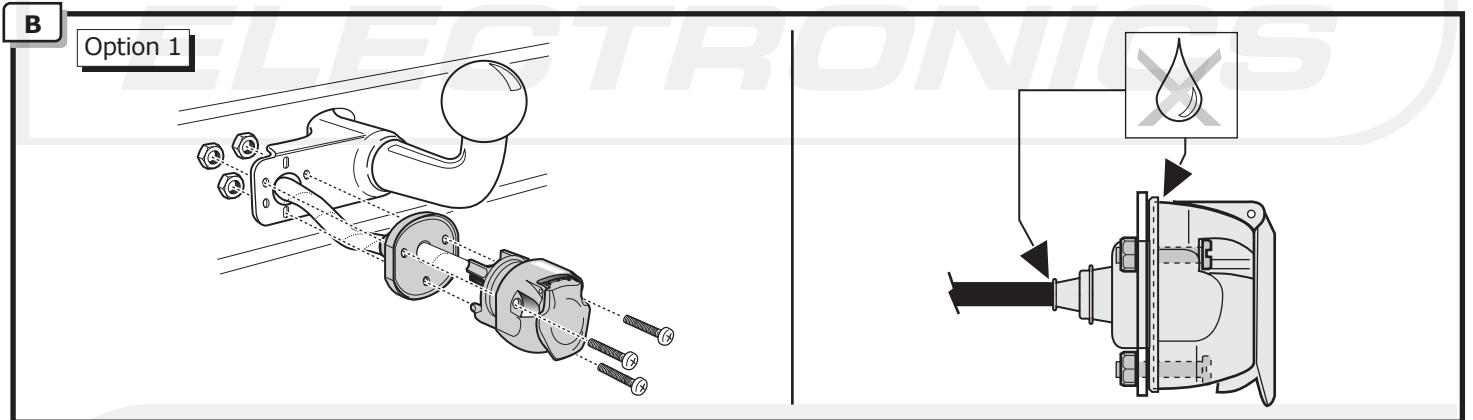

5

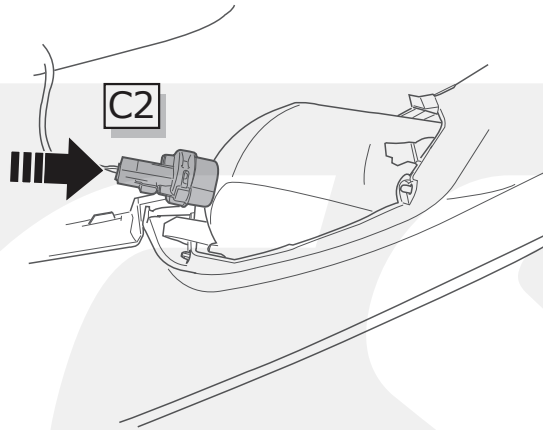
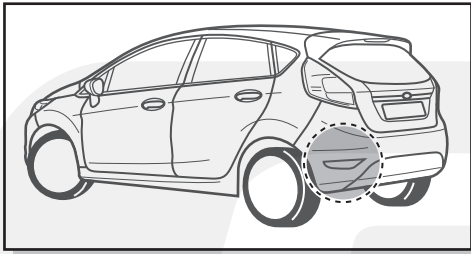

6

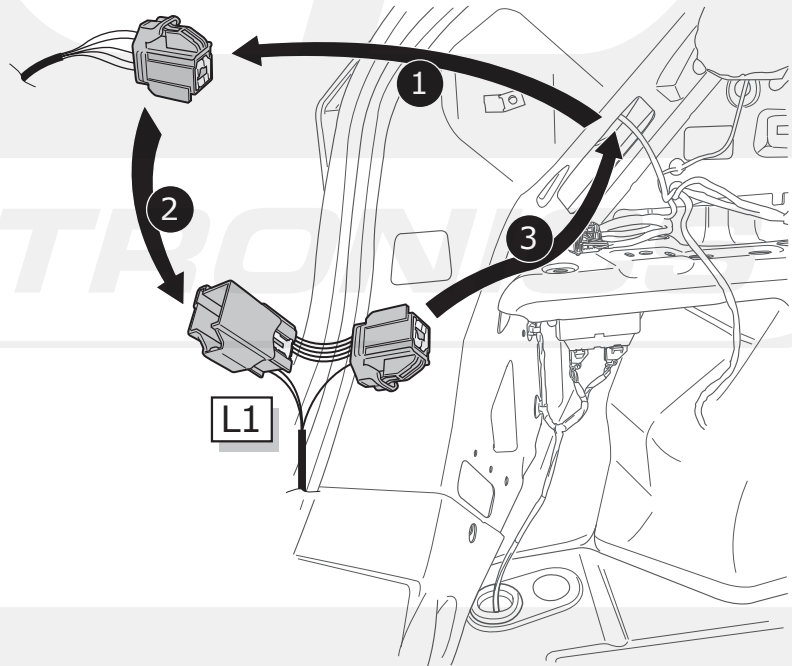
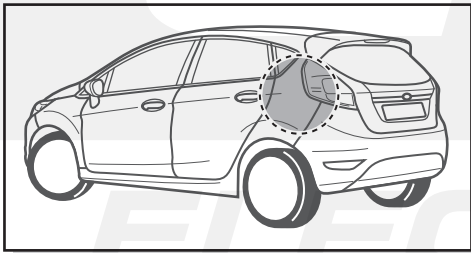

7

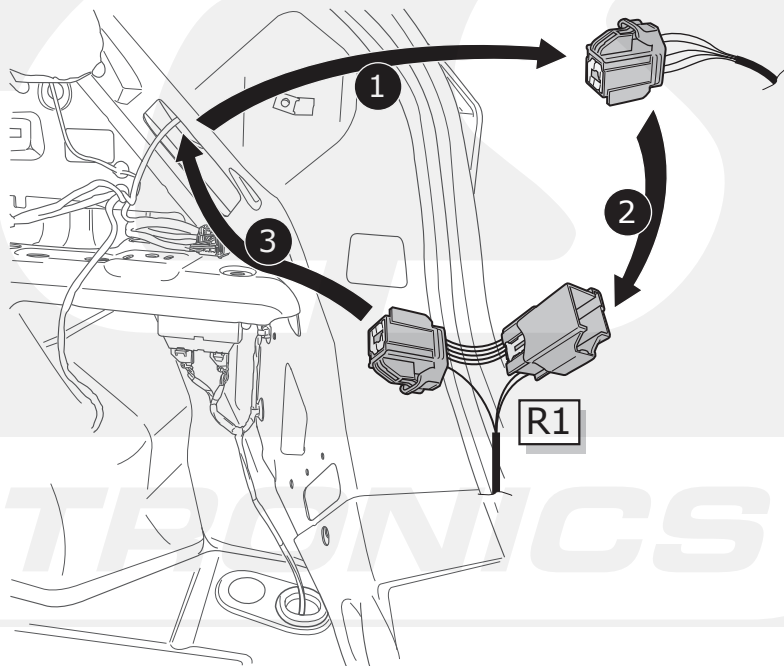
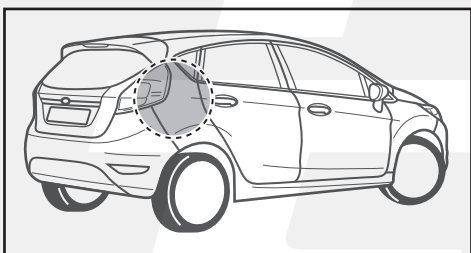

8

1

2

4

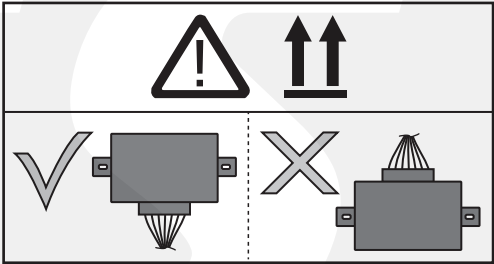
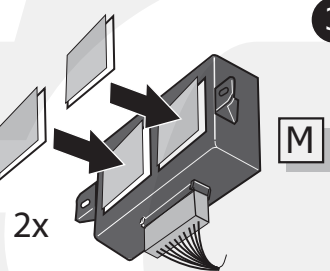
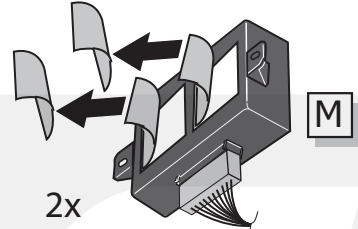
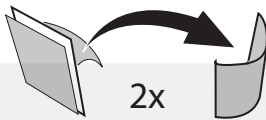
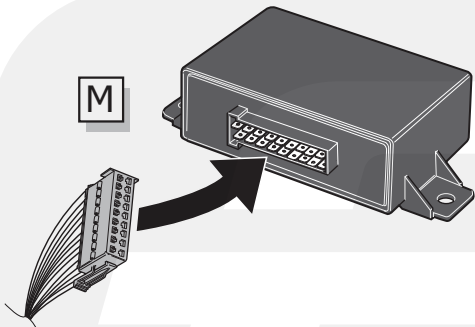

9

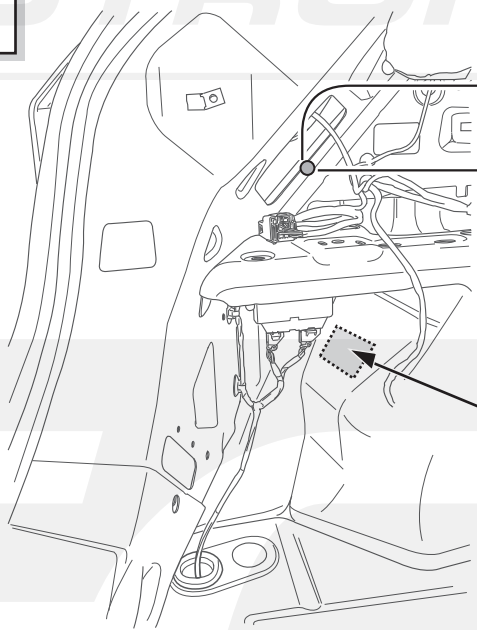
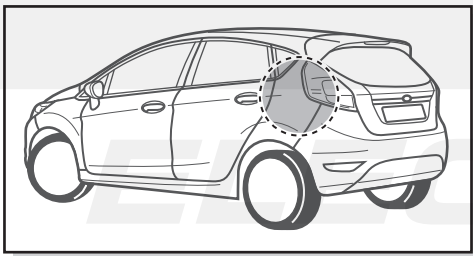

1

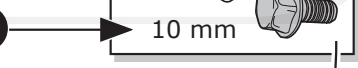

2

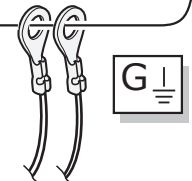

3

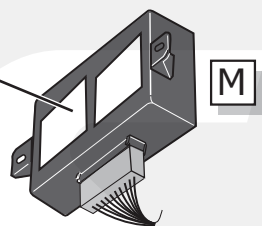

10

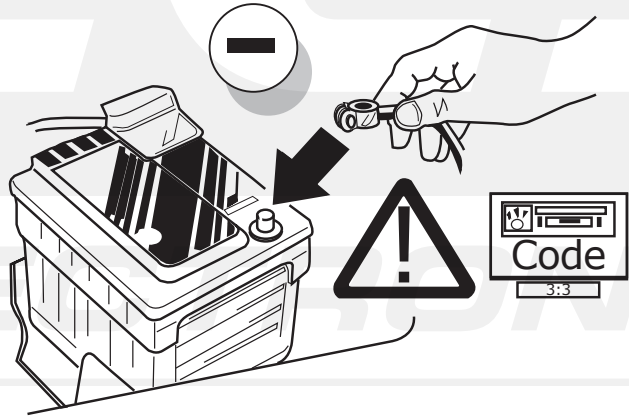

INFO



1

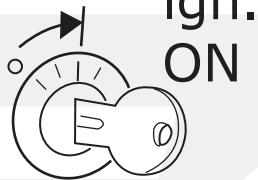

2

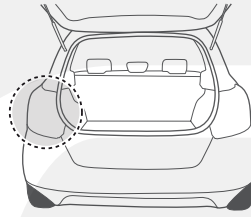

3

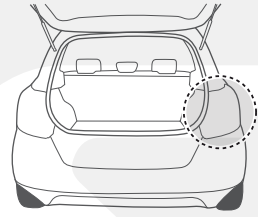

4

11

- DE** FUNKTIONEN KONTROLLIEREN MIT EINEM PRÜFGERÄT MIT WIDERSTAND ODER MIT LEUCHTEN MIT DER GENAUEN WATTZAHL!
- FR** CONTRÔLER LES FONCTIONS AVEC UNE BOÎTE DE TEST AVEC DE LA CHARGE OU DES LAMPES AVEC LA QUANTITÉ CORRECTE DE WATT!
- NL** CONTROLEER FUNCTIES MET EEN TESTER MET BELASTING OF LAMPEN MET DE JUISTE WATTAGE!
- GB** TEST ALL CIRCUIT FUNCTIONS WITH A TESTBOX WITH THE CORRECT POWER LOAD FOR EACH UNIT. A TESTBOX ON WHICH ONLY LEDs ARE USED CAN NOT BE USED IN THIS CASE
- ES** ¡CONTROLAR FUNCIONES CON UN TESTER CON CARGA O LUCES CON EL CORRECTO WATTAJE!
- IT** CONTROLLA FUNZIONI CON UN TESTER CON CARICO O LAMPADIE DEL GIUSTO WATT-TAGGIO!
- SE** KONTROLLERA FUNKTIONERNA MED EN TESTARE MED BELASTNING ELLER LAMPOR MED RÄTT WATT-VÄRDE!
- CZ** OVĚŘTE FUNKCE POMOČÍ TESTOVACÍHO BOXU NEBO SVĚTEL S PŘÍSLUŠNÝM VÝKONEM!
- DK** CHECK FUNKTIONERNE MED EN TESTBOKS, MED BELASTNING ELLER MED LYGTTER MED DET KORREKTE ANTAL WATT!
- FI** TARKISTA TOIMINNOT KÄYTTÄMÄLLÄ TESTILAITE, JOSSA ON OIKEATEHOINEN KUORMITUS TAI OIKEATEHOISET LAMPUT!
- GR** ΕΛΕΓΕΤΕ ΤΙΣ ΛΕΙΤΟΥΡΓΙΕΣ ΜΕ ΉΝΑ ΚΙΒΩΤΙΟ ΔΟΚΙΜΗΣ ΜΕ ΦΟΡΤΙΟ Ή ΛΑΜΠΙΤΗΡΕΣ ΣΩΣΤΗΣ ΠΟΣΟΤΗΤΑΣ ΒΑΤ!
- NO** KONTROLER FUNKSJONENE MED EN TESTER MED BELASTNING ELLER LYSPÆRER MED RIKTIG WATTVERDI!
- PL** SPRAWDŹ FUNKCJE UŻYWAJĄC SKRZYŃKI TESTOWEJ Z OBciążeniem LUB PODŁĄCZONYMI ŻARÓWKAMI O ODPOWIEDNIEJ MOCY!

12

- DE** Einzelteile wieder einbauen
- FR** Montez les part enlèves
- NL** Terug plaatsen onderdelen
- GB** Reinstall linings
- ES** Reinstalar componentes
- IT** Rimetti a posto componenti
- SE** Sätt tillbaka delar
- CZ** Znovu zasuňte obložení
- DK** Påsæt beklædningen
- FI** Asenna verhoilut takaisin
- GR** Τοποθετήστε ξανά τις επενδύσεις
- NO** Sett tilbake deler
- PL** Założyć wykładzinę

13

- DE** Gebrauchsanleitung.
- FR** Mode d'emploi.
- NL** Gebruikershandleiding.
- GB** User guide.
- ES** Guía del usuario.
- IT** Manuale di istruzioni.
- SE** Bruksanvisning.
- CZ** Uživatelská příručka.
- DK** Brugervejledning.
- FI** Käyttöohjeet.
- GR** Οδηγός χρήσης.
- NO** Brukerveiledning.
- PL** Instrukcja obsługi.

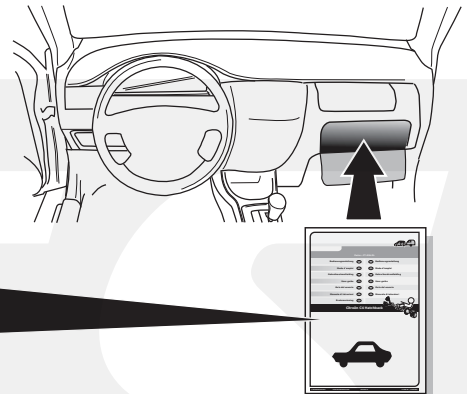

INFO



**00800
CALL2ECS
22 55 23 27**

**09.00 - 18.00
Monday - Friday**

www.ecs-electronics.nl

Products & Service

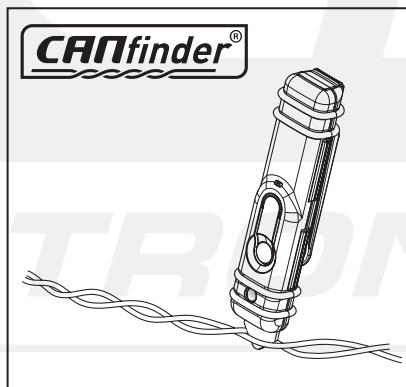

LIGHT MATE



http://www.ecs-electronics.nl/NL/catalogus/test_gereedschap

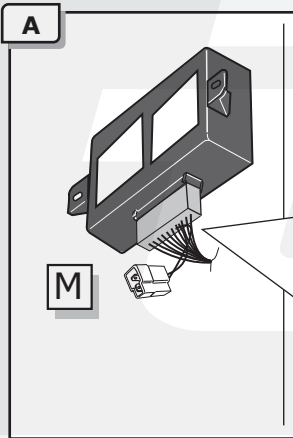
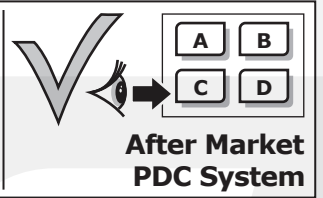
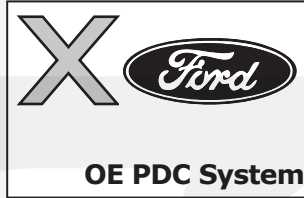
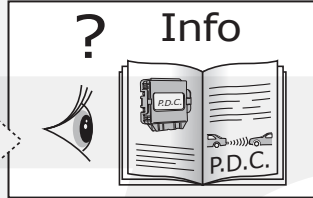
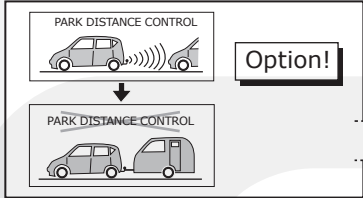

Option 1

NORMALLY CLOSED

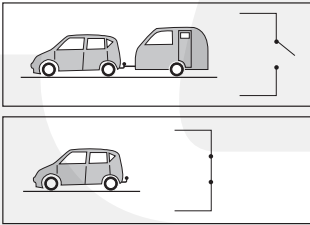
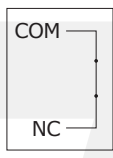

Option 2

NORMALLY OPEN

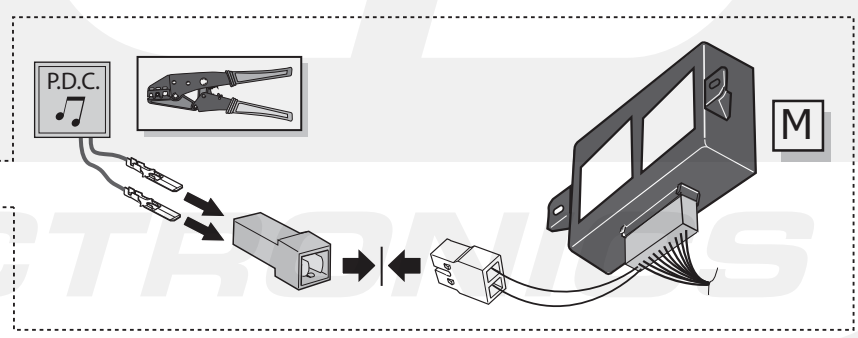
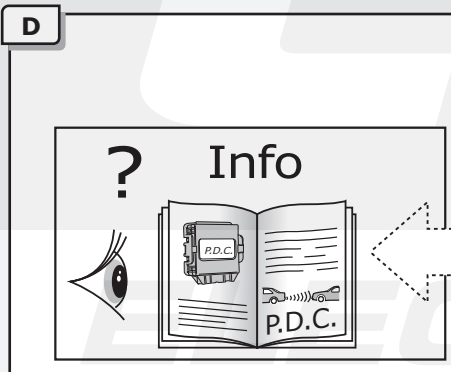
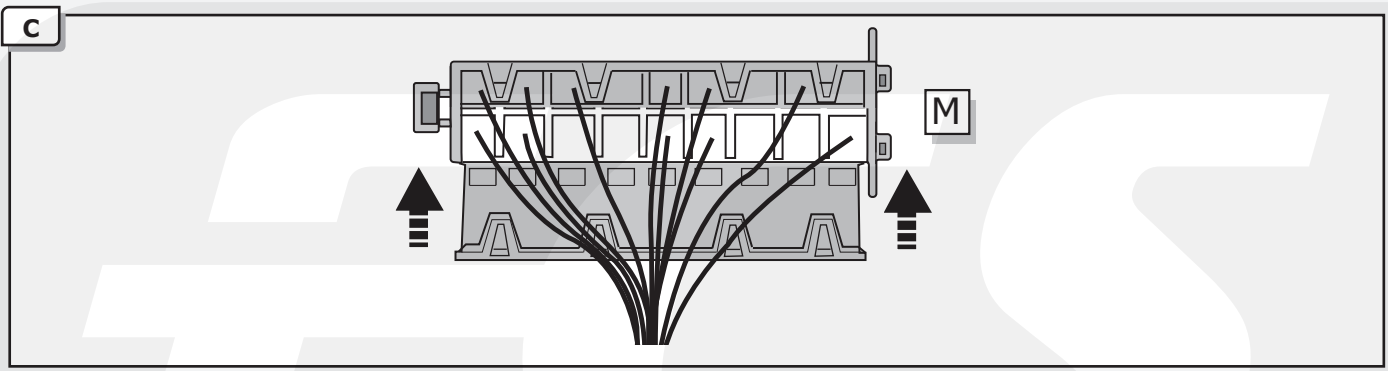
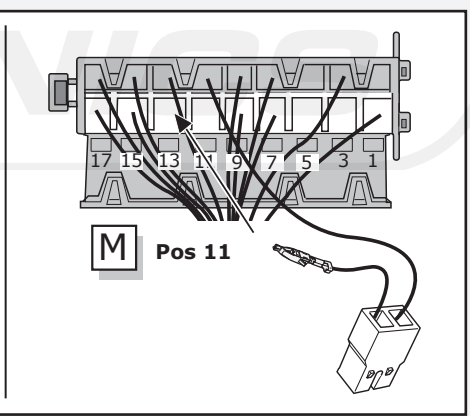
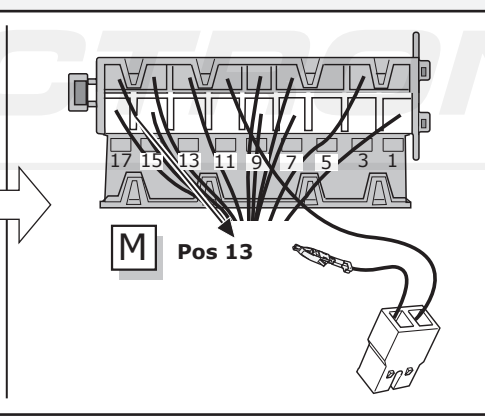
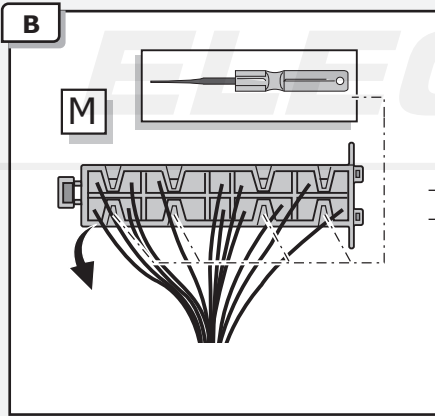
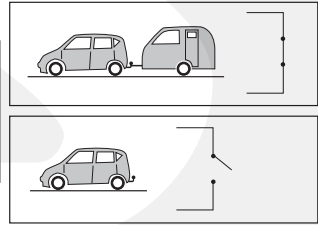
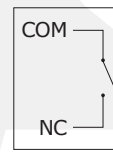

(DE) Anschluss Steckdose
 (FR) Connection de la prise
 (NL) Contactdoos aansluiting
 (GB) Socket connection

(ES) Conexión de la caja de enchufe
 (IT) Allaccio zoccolo
 (SE) Anslutning kontaktdosa

(CZ) Objímkový konektor
 (DK) Stikdåse forbindelse
 (FI) Pistorasia liitäntä
 (GR) Υποδοχή σύνδεσης
 (NO) Tilkobling koblingsboks
 (PL) Połączenie przez gniazdo

DIN/ISO 11446	↔		1-8	↕			6/54		Reverse				10	11	12	9
Pmax	1/L	2	3/31	4/R	5/58-R	52W	3x21W	7/58-L	8	180W/15Amp.	180W/15Amp.	10	11	12	13	
(DE)	Gelb	Blau	Weiß	Grün	Braun	Schwarz	Rot (1,00mm ²)	Schwarz	Schwarz/ Rot	Braun/ Weiß	Rot (2,50mm ²)	Weiß	Weiß	-	Weiß	
(FR)	Jaune	Bleu	Blanc	Vert	Marron	Noir	Rouge (1,00mm ²)	Noir	Noir/ Rouge	Marron/ Blanc	Rouge (2,50mm ²)	Blanc	Blanc	-	Blanc	
(NL)	Geel	Blauw	Wit	Groen	Bruin	Zwart	Rood (1,00mm ²)	Zwart	Zwart/ Rood	Bruin/ Wit	Rood (2,50mm ²)	Wit	Wit	-	Wit	
(GB)	Yellow	Blue	White	Green	Brown	Black	Red (1,00mm ²)	Black	Black/ Red	Brown/ White	Red (2,50mm ²)	White	White	-	White	
(ES)	Amarillo	Azul	Blanco	Verde	Marrón	Negro	Rojo (1,00mm ²)	Negro	Negro/ Rojo	Marrón/ Blanco	Rojo (2,50mm ²)	Blanco	Blanco	-	Blanco	
(IT)	Giallo	Blu	Bianco	Verde	Marrone	Nero	Rosso (1,00mm ²)	Nero	Nero/ Rosso	Marrone/ Bianco	Rosso (2,50mm ²)	Bianco	Bianco	-	Bianco	
(SE)	Gul	Blä	Vit	Grön	Brun	Svart	Röd (1,00mm ²)	Svart	Svart/ Röd	Brun/ Vit	Röd (2,50mm ²)	Vit	Vit	-	Vit	
(CZ)	Žlutá	Modrá	Bílá	Zelená	Hnědá	Černá	Červená (1,00mm ²)	Černá	Černo/ Červená	Hnědo/ Bílá	Červená (2,50mm ²)	Bílá	Bílá	-	Bílá	
(DK)	Gul	Blå	Hvid	Grøn	Brun	Sort	Rød (1,00mm ²)	Sort	Sort/ Rød	Brun/ Hvid	Rød (2,50mm ²)	Hvid	Hvid	-	Hvid	
(FI)	Keltainen	Sininen	Valkoinen	Vihreä	Ruskea	Musta	Punainen (1,00mm ²)	Musta	Musta/ Punainen	Ruskea/ Valkoinen	Punainen (2,50mm ²)	Valkoinen	Valkoinen	-	Valkoinen	
(GR)	Κίτρινο	Μπλε	Λευκό	Πράσινο	Καφέ	Μαύρο	Κόκκινο (1,00mm ²)	Μαύρο	Μαύρο/ Κόκκινο	Καφέ/ Λευκό	Κόκκινο (2,50mm ²)	Λευκό	Λευκό	-	Λευκό	
(NO)	Gul	Bla	Hvit	Grønn	Brun	Svart	Rød (1,00mm ²)	Svart	Svart/ Rød	Brun/ Hvit	Rød (2,50mm ²)	Hvit	Hvit	-	Hvit	
(PL)	Żółty	Niebieski	Biały	Zielony	Brazowy	Czarny	Czerwony (1,00mm ²)	Czarny	Czarny/ Czerwony	Brazowy/ Biały	Czerwony (2,50mm ²)	Biały	Biały	-	Biały	