

- (NL) Montagehandleiding
- (D) Montageanleitung
- (GB) Fitting instruction
- (F) Instruction de montage
- (E) Instrucciones de montaje
- (DK) Montagevejledning
- (N) Monteringsveiledning
- (S) Monteringshandledning
- (FIN) Asennusohje
- (I) Istruzioni di montaggio
- (CZ) Návod k montáži
- (PL) Instrukcja montażu
- (H) Szerelési utasítás

Partnr.: 019554

Kit t.b.v. 4-gats kogel 30970
 Zusatz-Set für Anhängerkupplung mit 4 Löchern (30970)
 Extension set for ball with 4 holes (30970)
Jeu alésoir pour une boule d'attelage à 4 trous (30970)

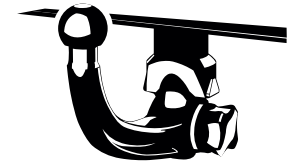

(c) ACPS Automotive



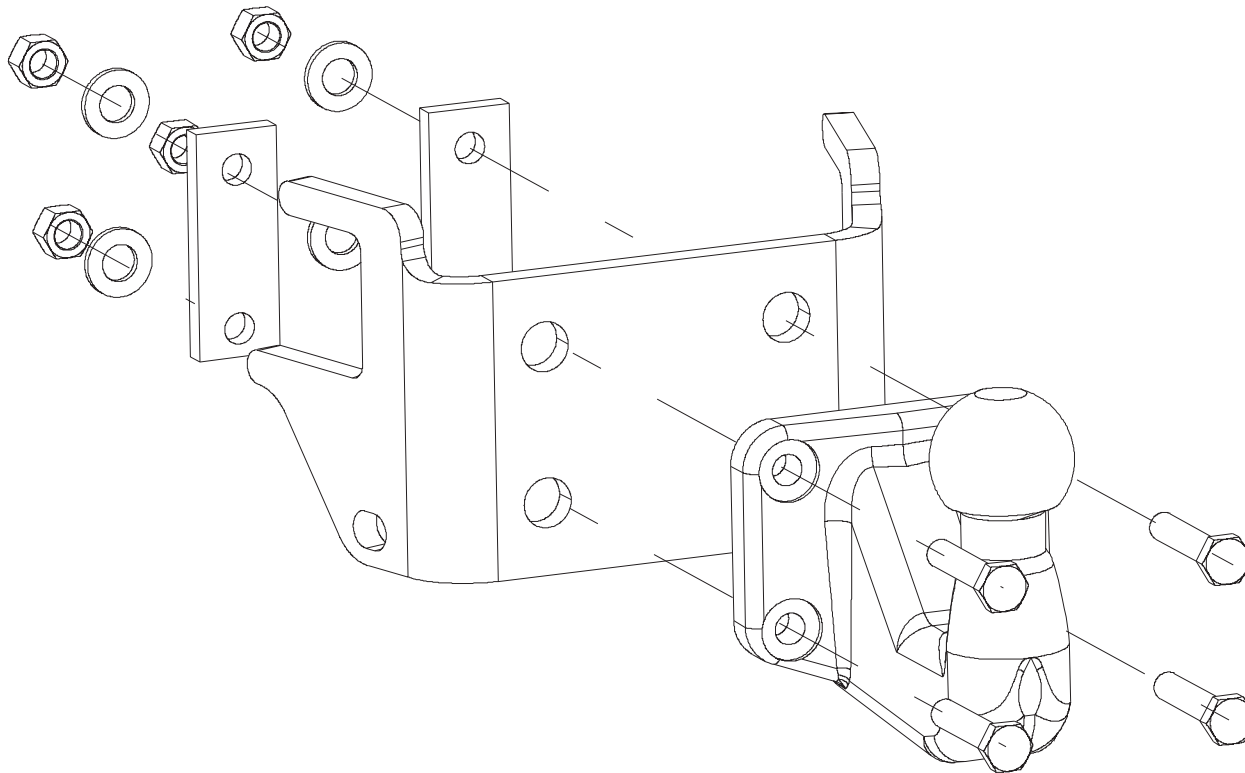

Date: 10-10-2023
 Rev. nr. 04

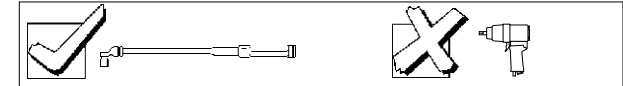

	8.8		10.9	
	8.8	10.9	8.8	10.9
M6	9,5 Nm	14 Nm		
M8	23 Nm	34 Nm		
M10	46 Nm	68 Nm		
M12	79 Nm	117 Nm		
M12x100/110				100 Nm
M14	125 Nm	185 Nm		
M16	195 Nm	280 Nm		
M10x1,25	49 Nm	72 Nm		
M12x1,25	87 Nm	125 Nm		
M12x1,5	83 Nm	122 Nm		

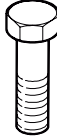

Meegeleverde onderdelen Mitgelieferte Befestigungsteile Provided parts	Materiel de fixation joint Piezas incluidas Medfølgende komponenter	Vedlagt festemateriell Medföljande komponenter Mukana tulevat osat	Componenti forniti a corredo Dodané upevňovací díly Dostarczone części wymienn Általunk biztosított alkatrészek
--	---	--	--

 4x M10x50(10.9)		4x M10 kl.10
		4x M10
		2x 30x8-80