







NORMACLAMP® CC



Best-in-class clamp for trucks to produce constantly sealed joints in charge air applications

- ✓ Extremely high clamping force thanks to omega-profile shaped band design with double sealing lines
- ✓ Low weight as the spring function is included in the omega profile
- ✓ Uniform radial distribution of the clamping force

-  Air Intake & Induction
-  Exhaust Systems
-  Cooling Systems
-  Fuel & Oil Systems
-  Turbocharger Installations
-  Fixing & Retaining

NORMACLAMP® CC

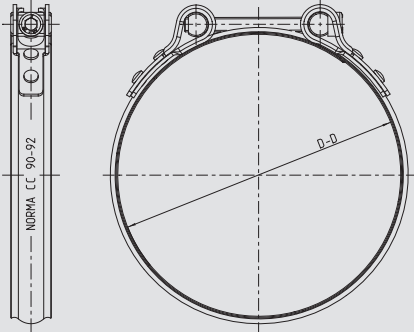

Note:
D-D refers to clamping range.

Applications

CC clamps are used in trucks to produce airtight joints in charge air applications under extremely high temperature and pressure variations.

Materials

Group	W3
-------	----



Part number	Description	Clamping range (mm)	Packaging quantity (pcs)
0596 6001 072	CC 70-72	70-72	100
0596 6001 074	CC 72-74	72-74	100
0596 6001 076	CC 74-76	74-76	250
0596 6001 078	CC 76-78	76-78	250
0596 6001 080	CC 78-80	78-80	250
0596 6001 082	CC 80-82	80-82	250
0596 6001 084	CC 82-84	82-84	100
0596 6001 086	CC 84-86	84-86	100
0596 6001 088	CC 86-88	86-88	100
0596 6001 090	CC 88-90	88-90	100
0596 6001 092	CC 90-92	90-92	100
0596 6001 094	CC 92-94	92-94	100
0596 6000 096	CC 94-96	94-96	100
0596 6000 098	CC 96-98	96-98	100
0596 6000 100	CC 98-100	98-100	100
0596 6000 102	CC 100-102	100-102	100
0596 6000 104	CC 102-104	102-104	100
0596 6000 106	CC 104-106	104-106	100
0596 6001 108	CC 106-108	106-108	100
0596 6001 110	CC 108-110	108-110	100
0596 6000 112	CC 110-112	110-112	100
0596 6000 114	CC 112-114	112-114	100
0596 6000 116	CC 114-116	114-116	100
0596 6000 122	CC 120-122	120-122	100
0596 6000 124	CC 122-124	122-124	100
0596 6000 126	CC 124-126	124-126	100
0596 6000 134	CC 132-134	132-134	100

More benefits

- ✓ Mechanical joints with rivets ensure no intracrystalline corrosion
- ✓ Low leakage rate due to high surface pressure, even under extreme temperature and pressure conditions

NORMACLAMP® CC is part of a broad portfolio. Discover more!



V QRC



Eurocoupler



Do you have questions or require a personal consultation?

Feel free to contact our Automotive Aftermarket Team! Hotline +44 1635 574 005

Visit our website for more information about our Automotive Aftermarket products: norma-aftermarket.com

