

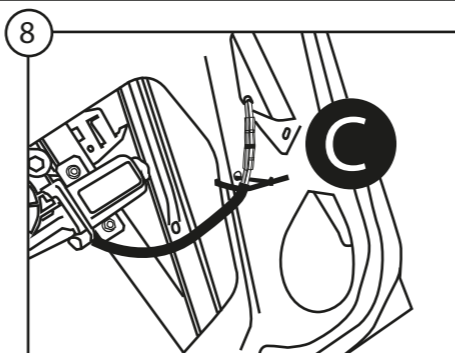

YouTube

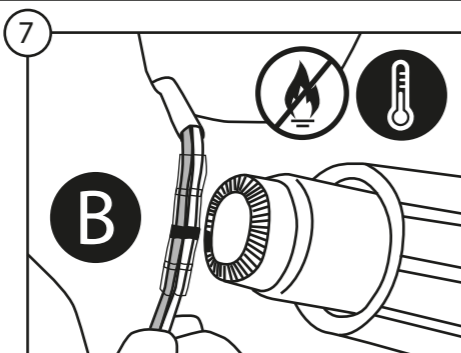
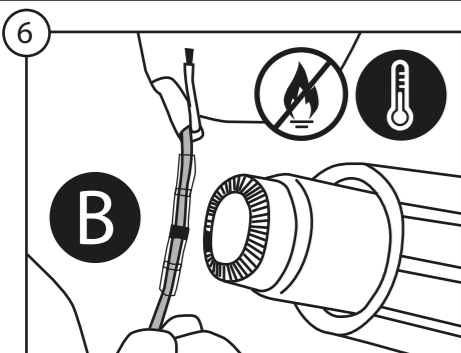
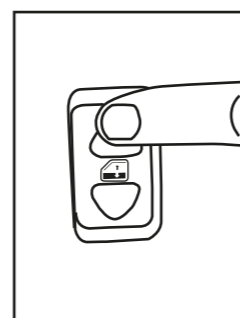
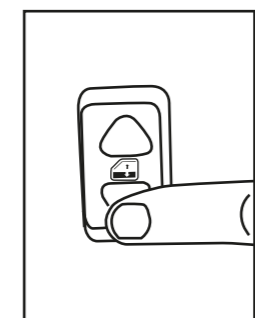
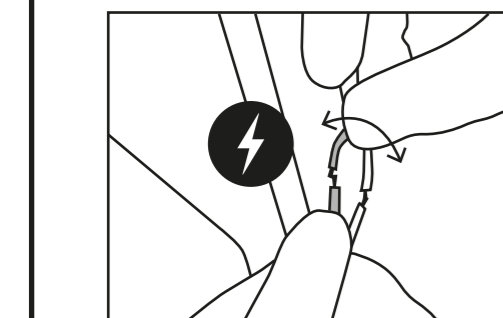
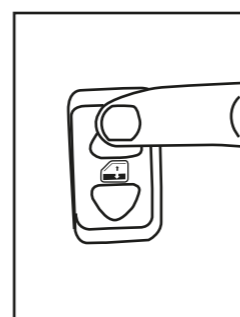
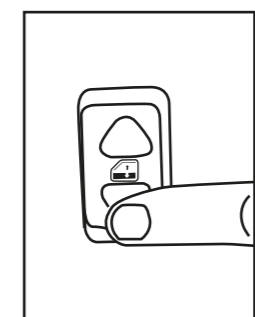
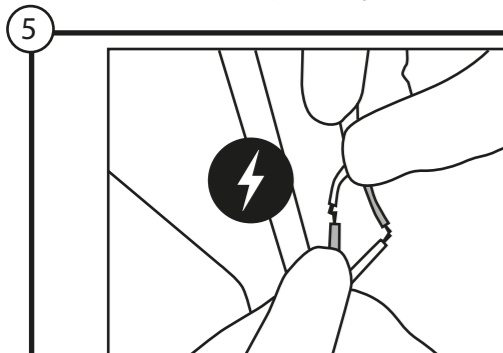
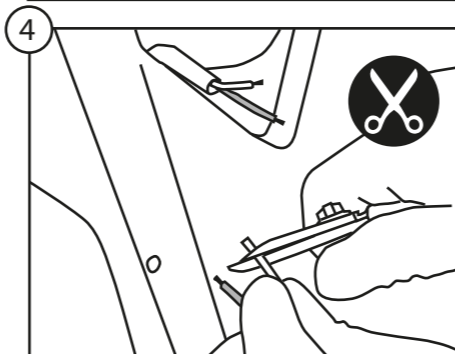
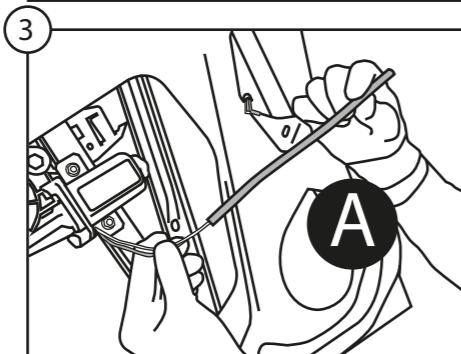
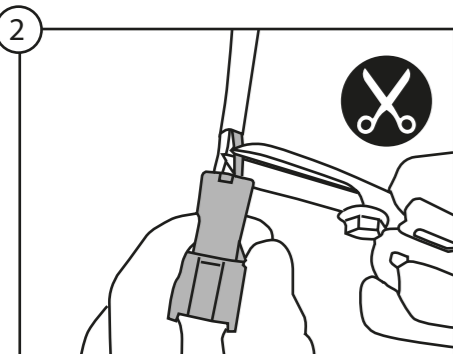
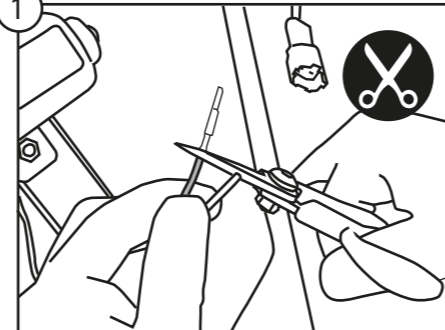
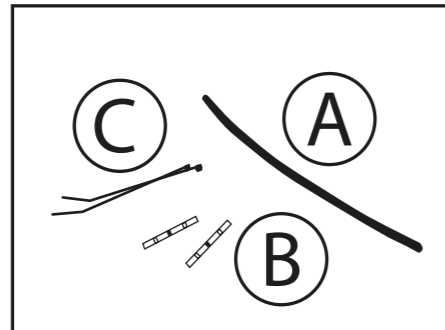
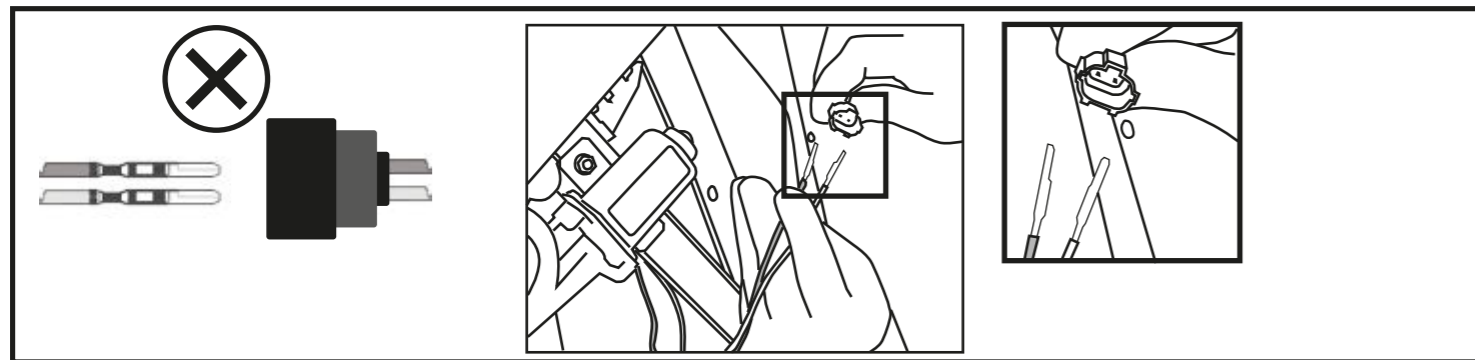

I ISTRUZIONI DI MONTAGGIO

- Per installare correttamente l'alzacristallo procedere come segue:
- Smontare con cura il pannello porta e rimuovere il vecchio alzacristallo scollegandolo sia meccanicamente che elettricamente.
 - Inserire l'alzacristallo di ricambio nella porta attraverso l'apposito vano.
 - Fissare l'alzavetro alla portiera nei punti 1, 2, 3, 4 e 5.
 - Collegare elettricamente l'alzacristallo. Se la connessione elettrica dell'alzacristallo non è compatibile con quella della vettura, seguire le istruzioni di collegamento elettrico.
 - Agganciare il cristallo all'alzavetro.
 - Verificare il funzionamento generale. Rimontare il pannello porta.

Grazie per la fiducia.

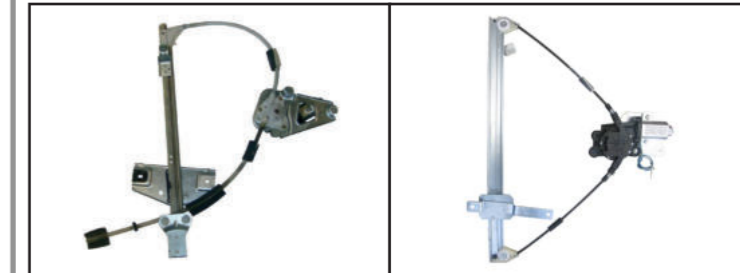

Alzacristallo originale - oem window regulator - lève-vitre original - Fensterheber von oem - elevallunas original - levantador de vidro original - orijinal cam acacagi - Γρύλος γήσιος

Nostro alzacristallo - our window regulator - notre lève-vitre - unser Fensterheber - nuestro elevallunas-nosso levantador de vidro - bizim cam acacagi - Γρύλος γήσιος

F INSTRUCTIONS DI MONTAGE

- Per installare correttamente l'alzacristallo procedere come segue:
- Smontare con cura il pannello porta e rimuovere il vecchio alzacristallo scollegandolo sia meccanicamente che elettricamente.
 - Inserire l'alzacristallo di ricambio nella porta attraverso l'apposito vano.
 - Fissare l'alzavetro alla portiera nei punti 1, 2, 3, 4 e 5.
 - Collegare elettricamente l'alzacristallo. Se la connessione elettrica dell'alzacristallo non è compatibile con quella della vettura, seguire le istruzioni di collegamento elettrico.
 - Agganciare il cristallo all'alzavetro.
 - Verificare il funzionamento generale. Rimontare il pannello porta.

Grazie per la fiducia.

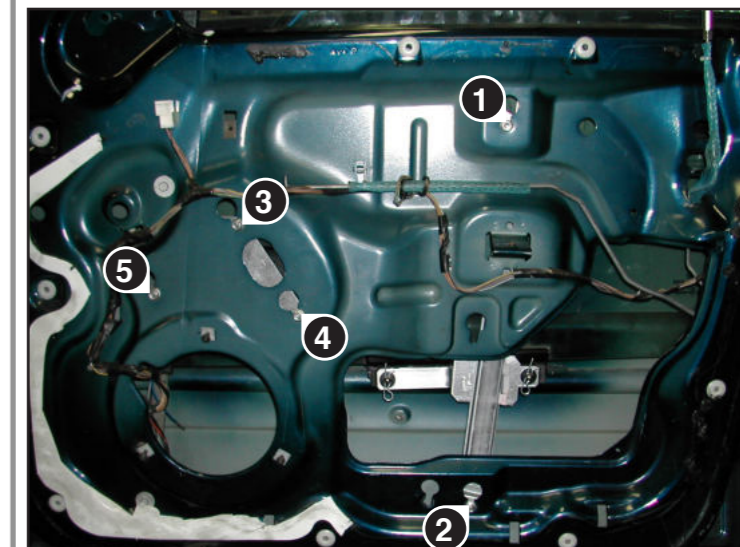

GB ASSEMBLY INSTRUCTIONS

- To install the window regulator:
- Disassemble the door: carefully disconnect the old window regulator mechanically and electrically and remove it.
 - Place the new window regulator in the door through the opening.
 - Attach the window regulator to points 1, 2, 3, 4 and 5.
 - Connect the window regulator to the car's electrics. If the window regulator's electrics are not compatible with those of the car, follow the instructions for the electrical connection.
 - Attach the car window glass to the window regulator.
 - Check overall functioning: reassemble the door.

Thank you for trust.





E INSTRUCCIONES DE MONTAJE

Para instalar correctamente el elevallas, haga lo siguiente:

- Desmonte el panel puerta con cuidado y extraiga el antiguo elevallas, debe desconectarlo mecánicamente y eléctricamente.
- Introduzca el elevallas de recambio en la puerta en el espacio específico.
- Fije el elevallas en la puerta en los puntos 1, 2, 3, 4 y 5.
- Conecte el elevallas eléctricamente. Si la conexión eléctrica del elevallas no es compatible con la del vehículo, siga las instrucciones para la conexión eléctrica.
- Enganche el cristal en el elevallas.
- Controle el funcionamiento general. Monte de nuevo el panel de la puerta.

Gracias por su confianza.

D MONTAGE ANWEISUNGEN

Zur korrekten Installierung des Fensterhebers folgend vorgehen:

- Die Tür Verkleidung vorsichtig entfernen, den alten Fensterheber ausbauen und die elektrische Stecker abziehen.
- Den neuen Fensterheber in die Türe durch die dafür vorgesehene Öffnung einführen.
- Den Fensterheber an den Punkten 1, 2, 3, 4 und 5 fixieren.
- Den Fensterheber elektrisch anschließen. Wenn der elektrische Anschluss des Fensterhebers nicht mit dem des Fahrzeugs kompatibel ist, die Anweisungen hinsichtlich des elektrischen Anschlusses befolgen.
- Die Scheibe an den Fensterheber einhängen.
- Einen Funktionstest durchführen und die Tür Verkleidung wieder montieren.

Danke für dein Vertrauen.

P INSTRUÇÕES PARA A MONTAGEM

Para instalar correctamente o dispositivo de levantar o vidro proceder como se segue:

- Desmontar com cuidado o painel da porta e remover o antigo dispositivo de levantar o vidro desconectando-o tanto mecânica como electricamente.
- Inserir o dispositivo de levantar o vidro sobresselente na porta através do vão específico
- Fixar o dispositivo de levantar o vidro na porta nos pontos 1, 2, 3, 4 e 5.
- Conectar electricamente o dispositivo de levantar o vidro. Se a conexão eléctrica do dispositivo de levantar o vidro não for compatível com a da viatura, seguir as instruções de conexão eléctrica.
- Engatar o cristal ao dispositivo de levantar o vidro.
- Verificar o funcionamento geral. Remontar o painel da porta.

Obrigado por sua confiança.

GR ΟΔΗΓΙΕΣ ΓΙΑ ΤΗΝ ΕΓΚΑΤΑΣΤΑΣΗ

Για να εγκαταστήσετε σωστά το μηχανισμό παραθύρου προβαίνετε ως εξής:

- Αποσυναρμολογήστε με επιμέλεια το πλαίσιο πόρτας και αφαιρέστε τον παλιό μηχανισμό παραθύρου αποσυνδέοντάς τον τόσο μηχανολογικά όσο και ηλεκτρολογικά.
- Εισάγετε τον ανταλλακτικό μηχανισμό στην πόρτα δια μέσω της ειδικής υποδοχής.
- Στερεώστε το μηχανισμό παραθύρου στα σημεία 1, 2, 3, 4 και 5.
- Συνδέστε ηλεκτρολογικά το μηχανισμό παραθύρου. Όταν η ηλεκτρική σύνδεση του μηχανισμού δεν είναι συμβατή με εκείνο του αυτοκινήτου
- Γαντζώνετε το τζάμι στο μηχανισμό παραθύρου.
- Ελέγχετε τη γενική λειτουργία.

Σε ευχαριστώ για την εμπιστοσύνη σου.

TR MONTAJ TALİMATLARI

Cam kaldırma mekanizmasını doğru şekilde monte etmek için aşağıdaki gibi işlem görünüz:

- Kapı panelini özenle sökünüz ve eski cam kaldırma mekanizmasını, bunu gerek mekanik gerekse elektriksel olarak çözürek, yerinden çıkarınız.
- Yedek cam kaldırma mekanizmasını özel bölmesi aracılığı ile kapıya geçiriniz
- Cam kaldırma mekanizmasını 1, 2, 3, 4 ve 5 noktalarında kapıya sabitleyiniz.
- Cam kaldırma mekanizmasının elektrik bağlantısını gerçekleştiriniz. Cam krikosunun elektrik bağlantısı arabadaki ile uyumlu değilse, elektrik bağlantısı talimatlarına başvurun.
- Cam kaldırma mekanizmasının elektrik bağlantısının tasitinki ile uyumlu olmaması halinde, elektrik bağlantısı bilgilerini izleyiniz.
- Cam kaldırma mekanizmasına camı takınız.
- Genel işlemeyi kontrol ediniz. Kapı panelini yeniden monte ediniz.

Güvendiğin için teşekkürler.

I

Attenzione: non azionare l'alzacristallo finché non sia stato completamente fissato e installato nel veicolo.
MANUTENZIONE

Per garantire il buon funzionamento dell'alzacristallo sostituito, accertatevi sempre che le canaline laterali in gomma (A) siano ben posizionate, pulite ed in buone condizioni. Inoltre è sempre consigliabile trattare le canaline (A) con grafite in polvere.

Attention: do not operate the window regulator until it has been completely secured and installed in the vehicle.
MAINTENANCE

To ensure the new window regulator works properly, check the side rubber window channels (A) are properly positioned, clean and in good condition. The window channels (A) should be treated with dust graphite.

Attention: ne pas faire fonctionner le lève-vitre avant de l'avoir complètement fixé et installé dans le véhicule.
ENTRETIEN

Pour garantir le bon fonctionnement du lève-vitre après son remplacement, toujours s'assurer que les joints latéraux en caoutchouc (A) sont bien positionnés, propres et en bon état. En outre, il est recommandé d'appliquer sur les joints (A) avec graphite en poudre.

Achtung: Betätigen Sie den Fensterheber nicht bis er vollständig gesichert und installiert im Fahrzeug ist.
WARTUNG

Um ein problemloses Funktionieren des Fensterhebers zu garantieren, vergewissern Sie sich immer, ob die seitlichen Führungsschienen aus Gummi (A) richtig positioniert, sauber und in gutem Zustand sind. Weiters wird empfohlen, die Führungsschienen (A) mit pulvergraphit.

Precaución: no ponga en marcha el elevallas antes de fijarlo y arreglarlo completamente al coche.
MANTENIMIENTO

Para garantizar el buen funcionamiento del elevallas nuevo hay que asegurarse siempre de que las muescas de guía laterales de caucho (A) estén bien colocadas, limpias y en buenas condiciones. Además es aconsejable siempre tratar las muescas de guía (A) con grafito en polvo.

Atenção: não opere o elevador vidro até que ele tenha sido totalmente seguro e instalado no veículo.
MANUTENÇÃO

Para garantir o bom funcionamento do elevador de vidros substituído, verificar sempre se as calhas laterais de borracha (A) estão bem colocadas, limpas e em boas condições. Além disso, é sempre aconselhável tratar as calhas (A) com grafite em pó.

Dikkat: Montaj işlemlerini tamamlamadan mekanizmayı çalıştırmayınız.
BAKÝM

Pencere düzeneğinin sağlıklı çalışabilmesi için yan taraflarda bulunan kauçuk kanalların (A) doğru konumlandırılmasına, temiz ve sağlam olmasına dikkat ediniz. Ayrıca, kanallara (A) toz grafit ile.

Προσοχή: Μην λειτουργείτε τον γρύλο παραθύρου πριν τοποθετηθεί στο όχημα και πριν ασφαλιστεί πλήρως
ΣΥΝΤΗΡΗΣΗ

Για να εξασφαλίσετε την καλή λειτουργία της διάταξης ανύψωσης των παραθύρων που αντικαταστήσατε, να βεβαιώνετε πάντα ότι τα τλαϊνά ελαστικά κανάλια (A) είναι σωστά τοποθετημένα, καθαρά και βρίσκονται σε καλή κατάσταση. Επίσης ενδείκνυται πάντα να περιποιείστε τα κανάλια (A) με γραφίτη σε σκόνη.

