

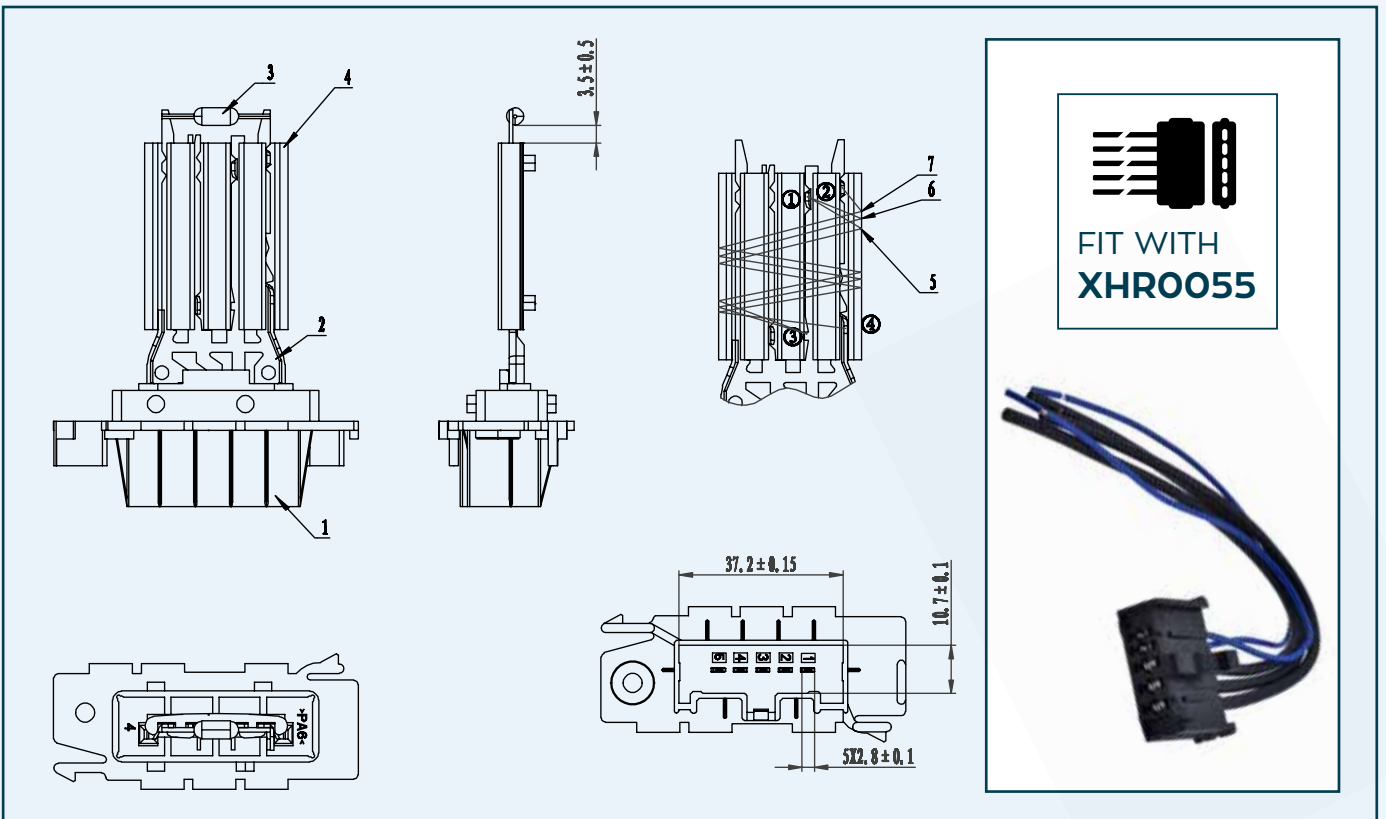

XHR0063 HEATER BLOWER MOTOR RESISTOR / CONTROLLER

PRODUCT SPECIFICATION



IMPORTANT FITTING ADVICE FOLLOWS





HEATER BLOWER MOTOR RESISTOR / CONTROLLERS

IMPORTANT FITTING ADVICE

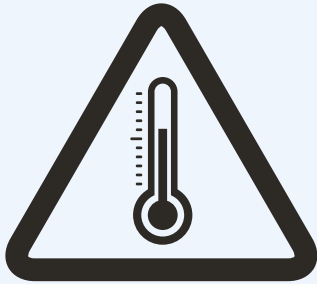

ENSURE ENGINE IS COOL BEFORE STARTING

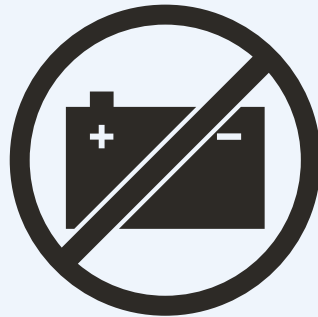

DISCONNECT BATTERY



ALWAYS REFER TO MANUFACTURERS INSTRUCTIONS

Before replacing the resistor/controller

1. It is important that tests are conducted to identify the heating component that needs replacing and the causes of failure.
2. Visually inspect the system for leaks from the heater core. If the heater core is leaking this should be resolved before replacing further components.
3. Check for damage to wiring and connectors and replace if required. Note that whilst damaged wiring and connectors could be the sole cause of the blower not functioning, the damage itself could have been caused by a failed resistor or motor drawing too much power. Therefore, continue to check further components.
4. Test the blower motor using an ohmmeter against specifications. If the motor is drawing too much power, it may be failing and could cause damage to any newly fitted resistors or connectors in time. If the motor has failed it will need to be replaced but continue to test the resistor and wiring as the failure may have damaged those components too.
5. Visually inspect the resistor for signs of corrosion then check the resistance between the terminals with an ohmmeter against specifications. Readings should usually be around 0-5 ohms. If an open circuit is reported, then the component has failed.



IF FAULTS PERSIST A PARAMETER RESET MAY BE REQUIRED. PLEASE SEE NEXT PAGE



HEATER BLOWER MOTOR RESISTOR / CONTROLLER

IMPORTANT FITTING ADVICE

After replacing engine management components, many vehicles will require a reset of the parameters to tell the ECU that a new part has been fitted. Without this, the ECU will believe that the engine is still running with faulty sensors and will default back to data already received before the replacement. This causes the vehicle to run poorly, normally with the Malfunction Indicator Lamp on and the fault code still logged in memory.



ALWAYS REFER TO
MANUFACTURERS
INSTRUCTIONS

Reset parameters as follows

1. Firstly, reset the vehicle using diagnostic tools.
2. If the fault code persists, perform a manual reset according to the manufacturers instructions, commonly as follows:
3. Carry out 3 drive cycles:
 - A. Turn ignition on, turn ignition off
 - B. Turn ignition on, turn ignition off
 - C. Start the engine.
4. An extended road test, normally around 20 miles is then required to provide the ECU with enough data to allow the sensor to function correctly.

TECHASSIST

“Fitting aftermarket sensors is similar to plugging an aftermarket device into a PC or laptop – the PC will recognise the new device, then find and install the drivers it needs to operate correctly. The vehicle’s ECU is very similar, it simply needs to calculate how best to use the newly fitted component.”