

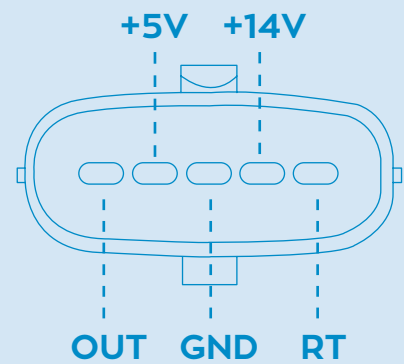

# XAM4033 MASS AIR FLOW SENSOR

## PRODUCT SPECIFICATION

### CONNECTOR



AIRFLOW



### TEST REPORT

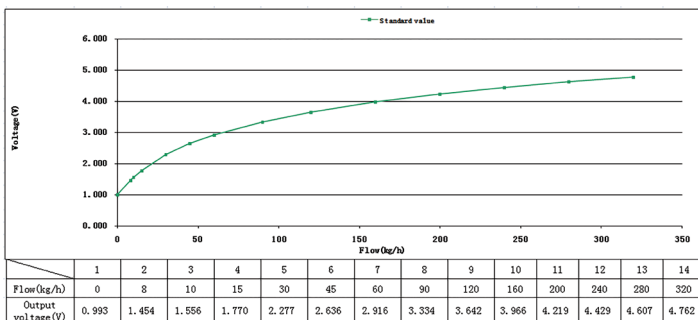

VOLTAGE	14V
CURRENT	<0.5A
LENGTH (MM)	96.5
DIAMETER IN (MM)	61.7
DIAMETER OUT (MM)	61.7



**IMPORTANT FITTING ADVICE FOLLOWS**





## MASS AIR FLOW SENSOR GENERAL FITTING ADVICE

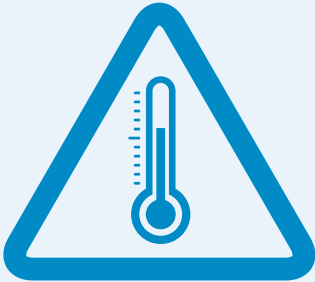

ENSURE ENGINE IS COOL BEFORE STARTING

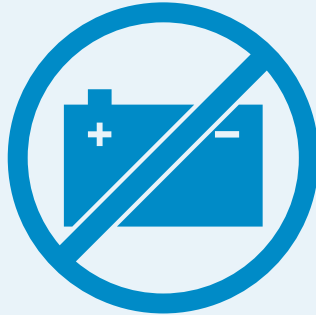

DISCONNECT BATTERY



ALWAYS REFER TO MANUFACTURERS INSTRUCTIONS

1. Before replacing the Mass Air Flow Sensor, check for existing fault codes that may prevent correct operation. EGR faults are common.
2. Check for possible causes of unmetered air into the system including;  
Blockages in air intake filters  
Leaking induction hoses  
Loose clamps  
Faulty tank ventilation valves
3. Check wiring and connectors for damage.
4. Change the Air Filter. It is highly recommended to change the air filter before replacing the MAFS. Dirty, sub standard or worn out air filters can contaminate the element of the sensor and cause it to fail. The Air Filter should be changed every 15,000 miles to ensure efficiency and durability of the Mass Air Flow Sensor.
5. Ensure correct Mounting Direction. Most Air Mass Meters have an arrow on the outer case to indicate the correct direction of airflow through the MAFS to the engine. Ensure the arrow points in the correct direction when mounting.
6. Allow the ECU to Reset. In most cases the ECU does not have to be manually reset but it may take some time for the ECU to recalibrate and reset the error code. This can take around 60 miles depending on the vehicle. If a manual reset is required please follow manufacturers instructions.



IF FAULTS PERSIST A PARAMETER RESET MAY BE REQUIRED. PLEASE SEE NEXT PAGE



## RESET PARAMETERS GENERAL ADVICE

After replacing engine management components, many vehicles will require a reset of the parameters to tell the ECU that a new part has been fitted. Without this, the ECU will believe that the engine is still running with faulty sensors and will default back to data already received before the replacement. This causes the vehicle to run poorly, normally with the Malfunction Indicator Lamp on and the fault code still logged in memory.



ALWAYS REFER TO  
MANUFACTURERS  
INSTRUCTIONS

### Reset parameters as follows

1. Firstly, reset the vehicle using diagnostic tools.
2. If the fault code persists, perform a manual reset according to the manufacturers instructions, commonly as follows:
3. Carry out 3 drive cycles:
  - A. Turn ignition on, turn ignition off
  - B. Turn ignition on, turn ignition off
  - C. Start the engine.
4. An extended road test, normally around 20 miles is then required to provide the ECU with enough data to allow the sensor to function correctly.

## TECHASSIST

“Fitting aftermarket sensors is similar to plugging an aftermarket device into a PC or laptop – the PC will recognise the new device, then find and install the drivers it needs to operate correctly. The vehicle’s ECU is very similar, it simply needs to calculate how best to use the newly fitted component.”