

x 2

L = 315

x 4

171.7

68.5

17

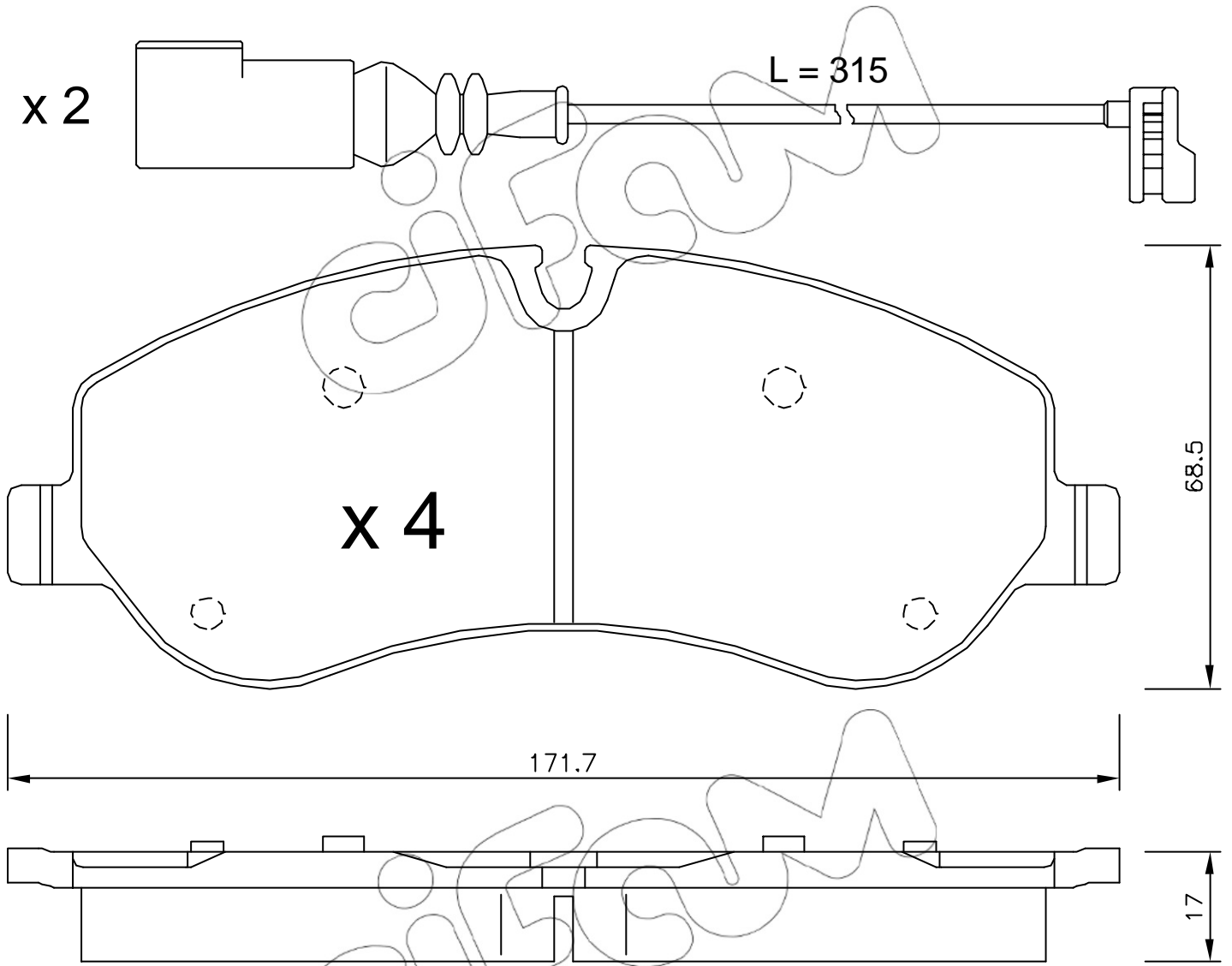

ifom