

x 2

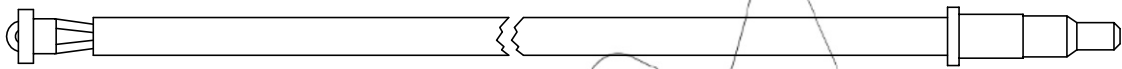

L = 230

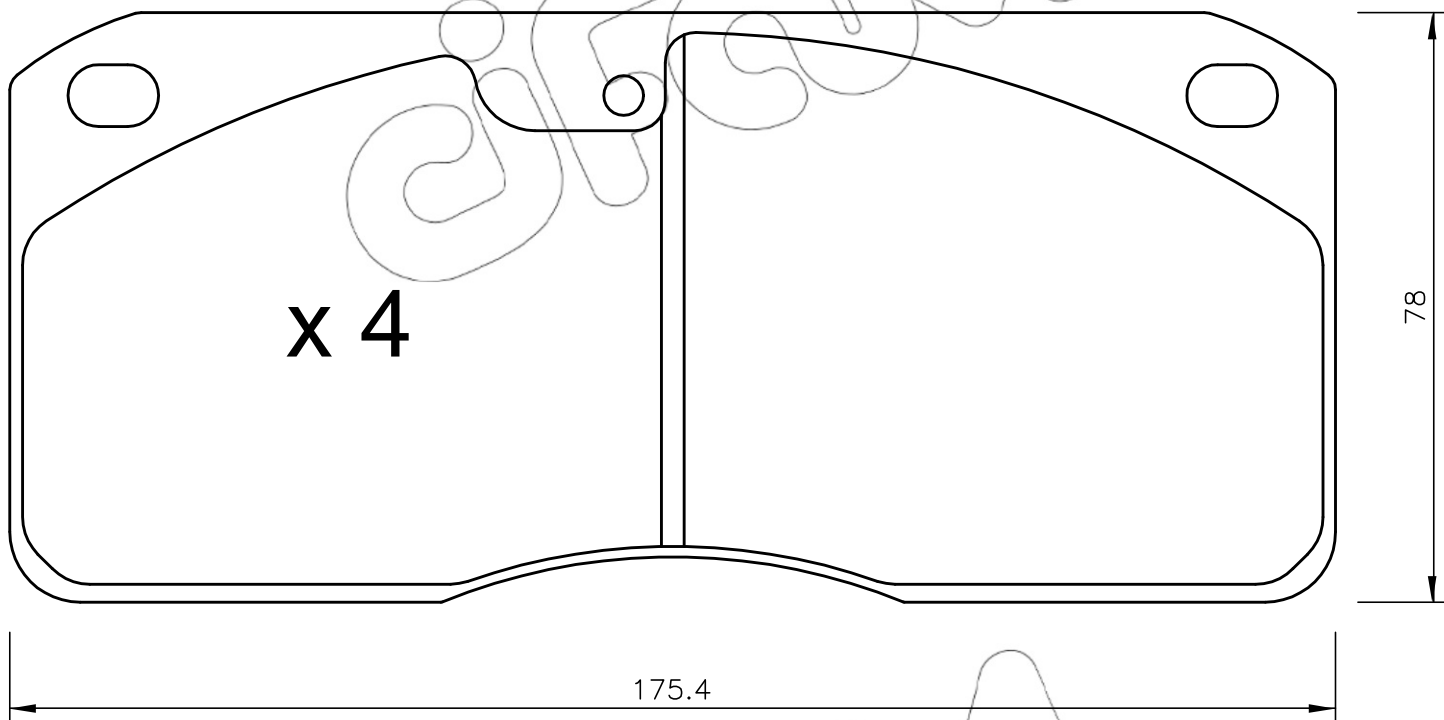

x 4

175.4

78

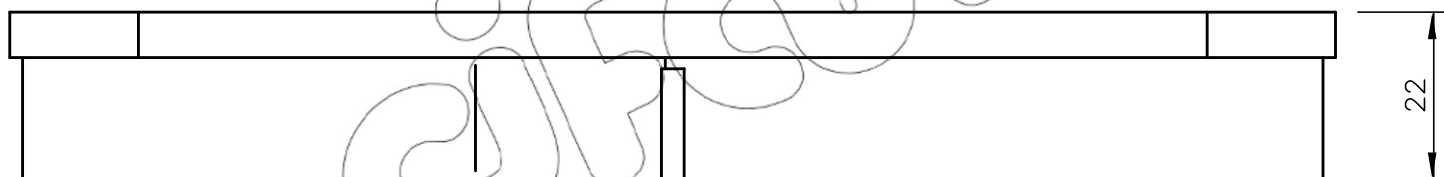

22

difam