

L = 210

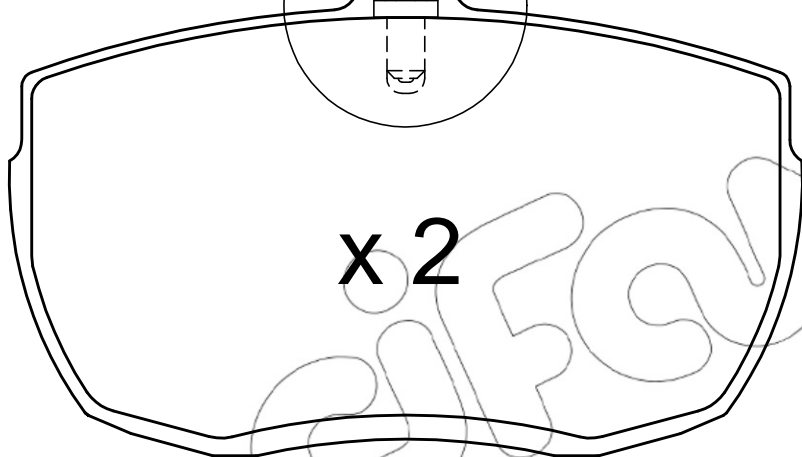

x 2

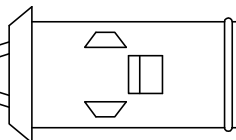
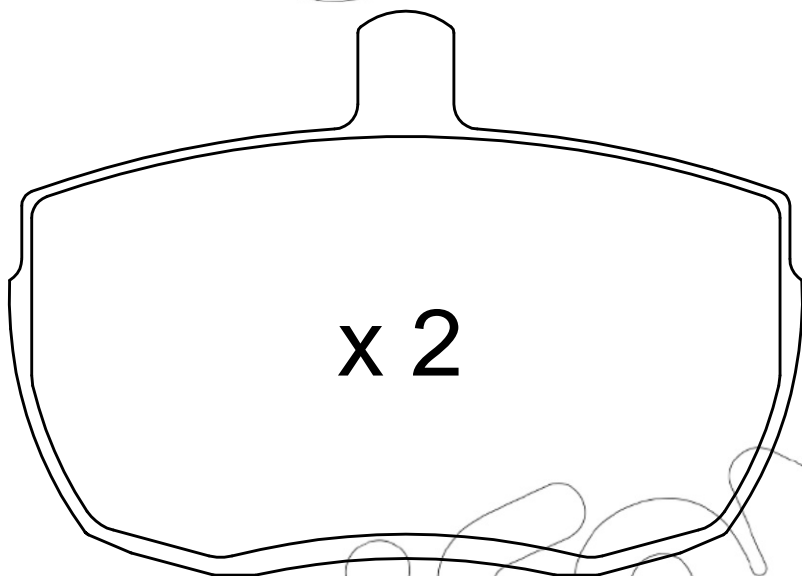
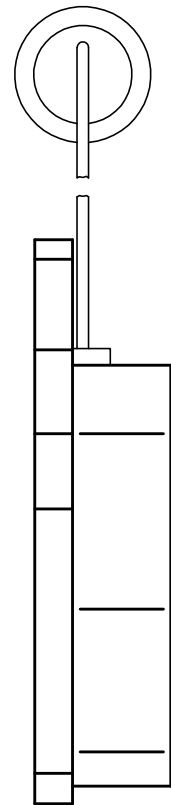

x 2

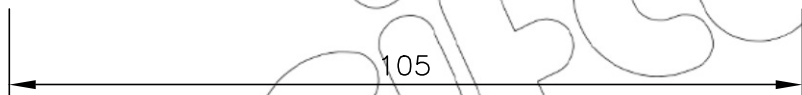

105

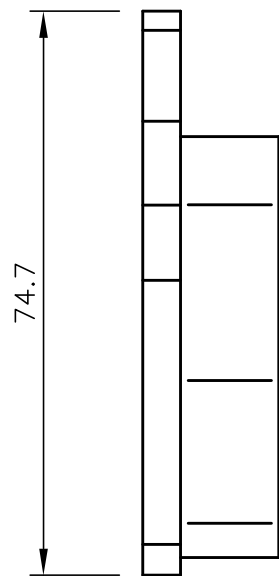

74.7

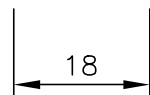

18