

x 2

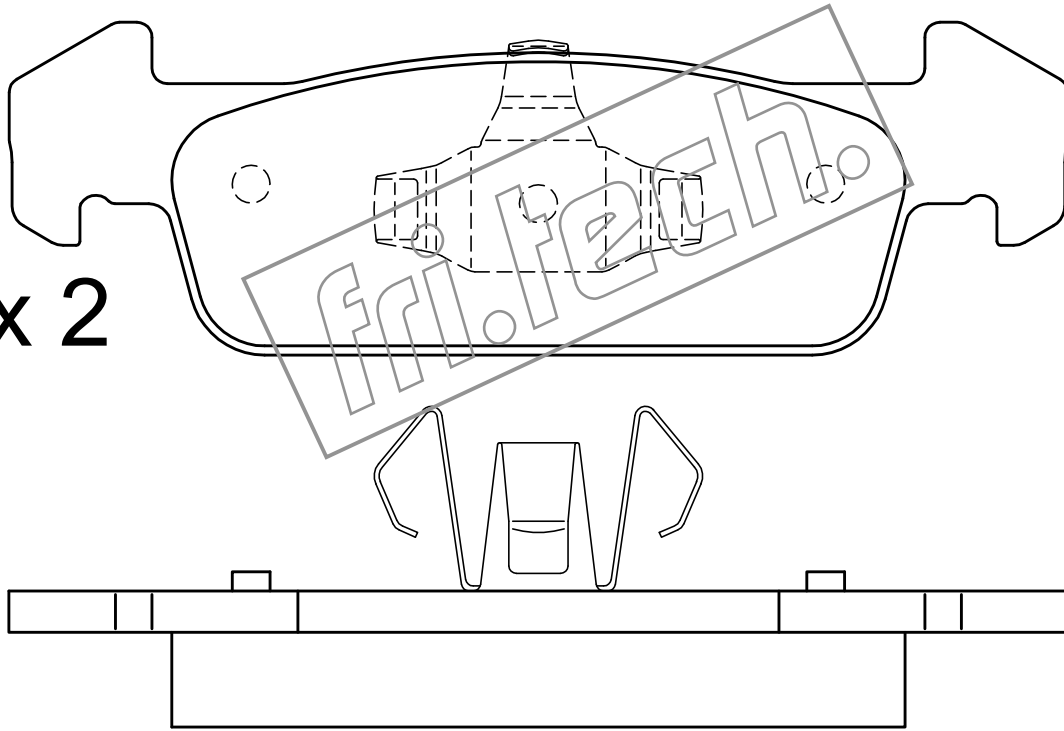

x 2

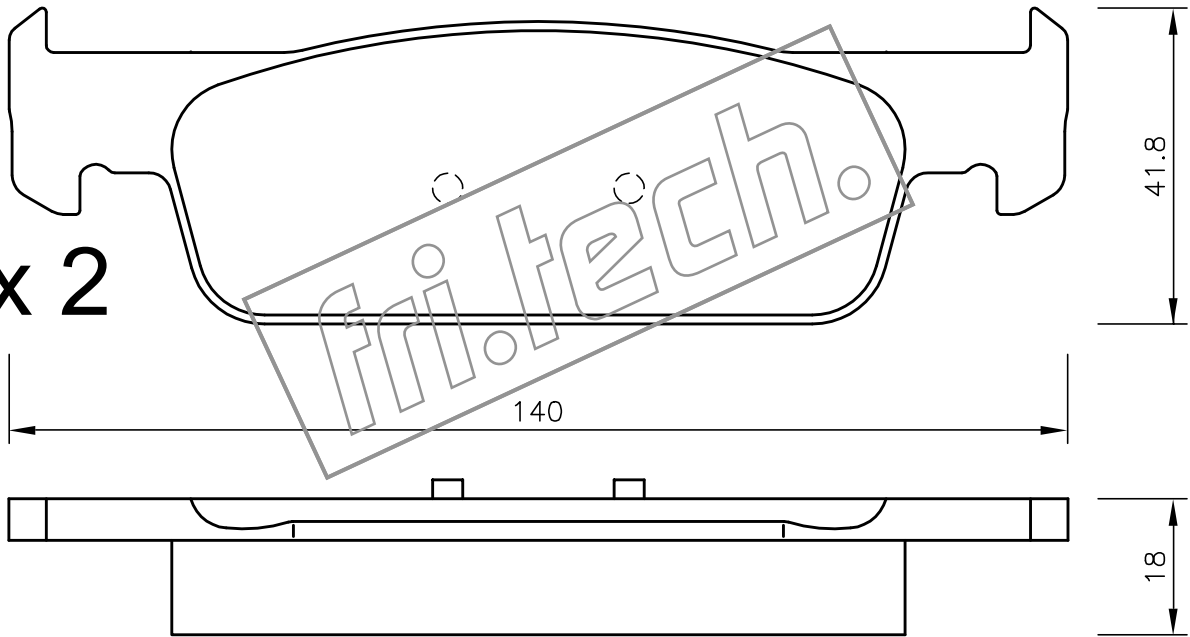

fri.tech.