

x 1

L = 170



x 4

64.5

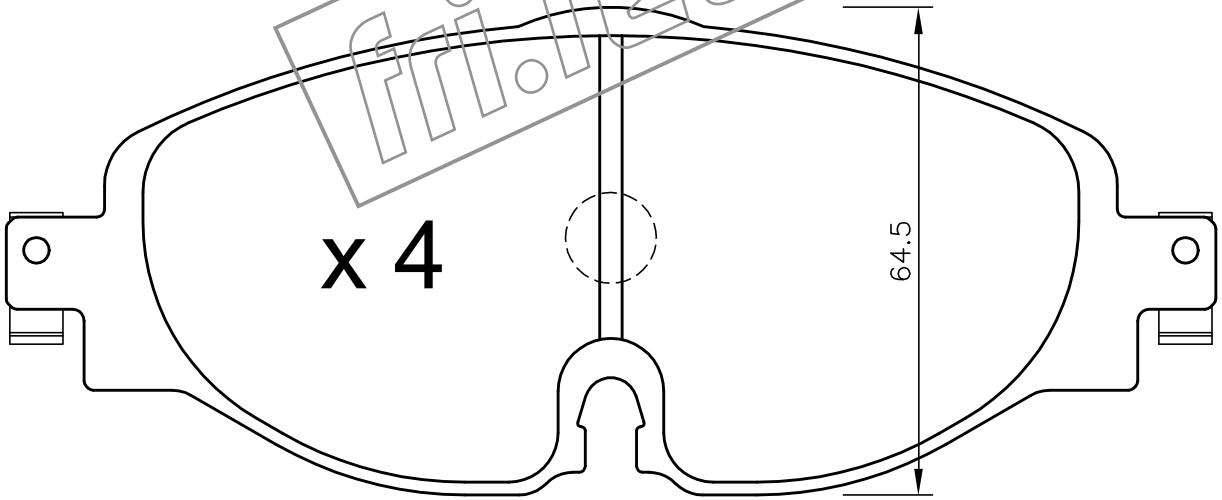

160

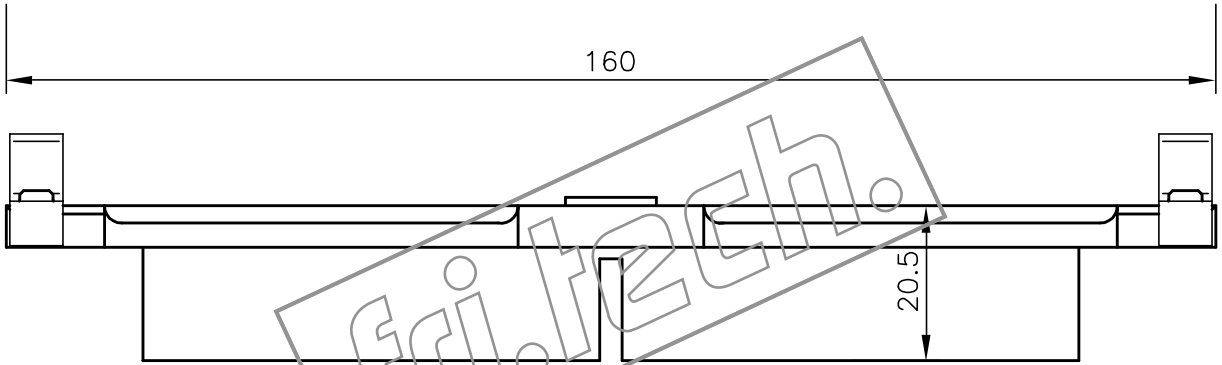

fri.tech.