

x 2

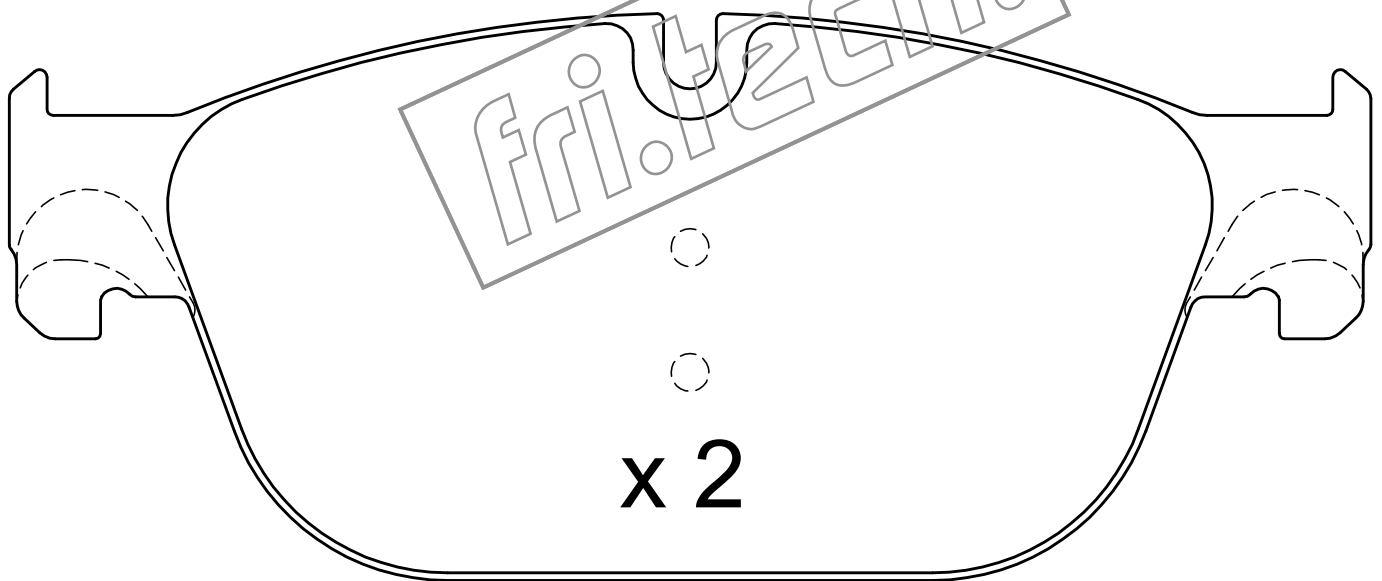

x 2

74.9

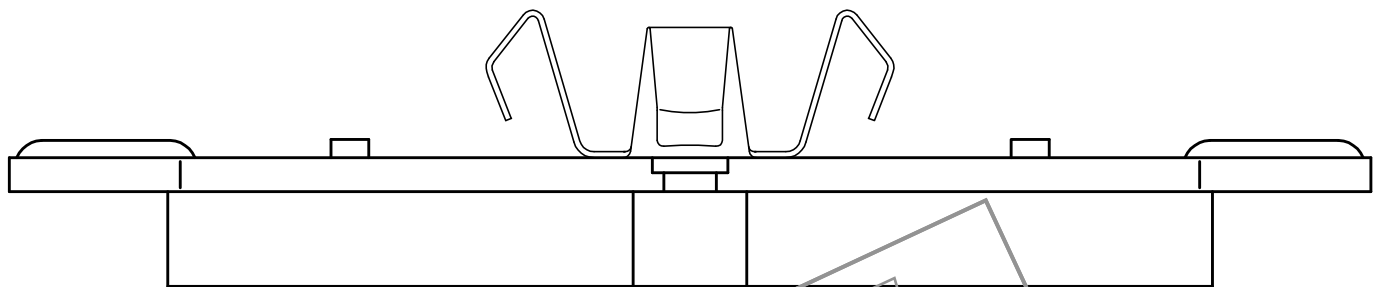
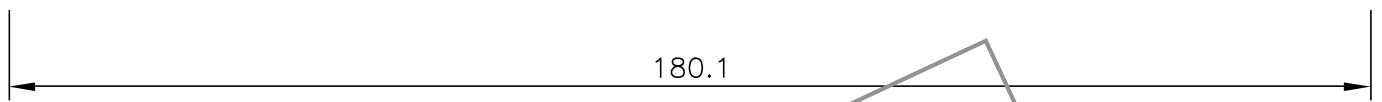

180.1

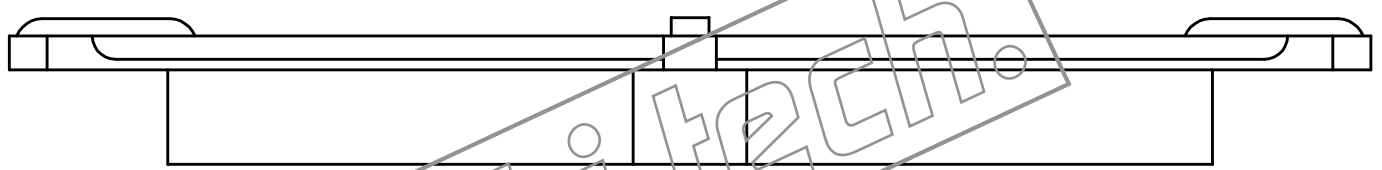

17