

x 2

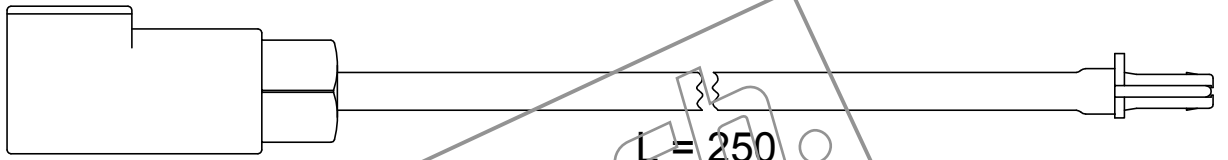

L = 250

x 4

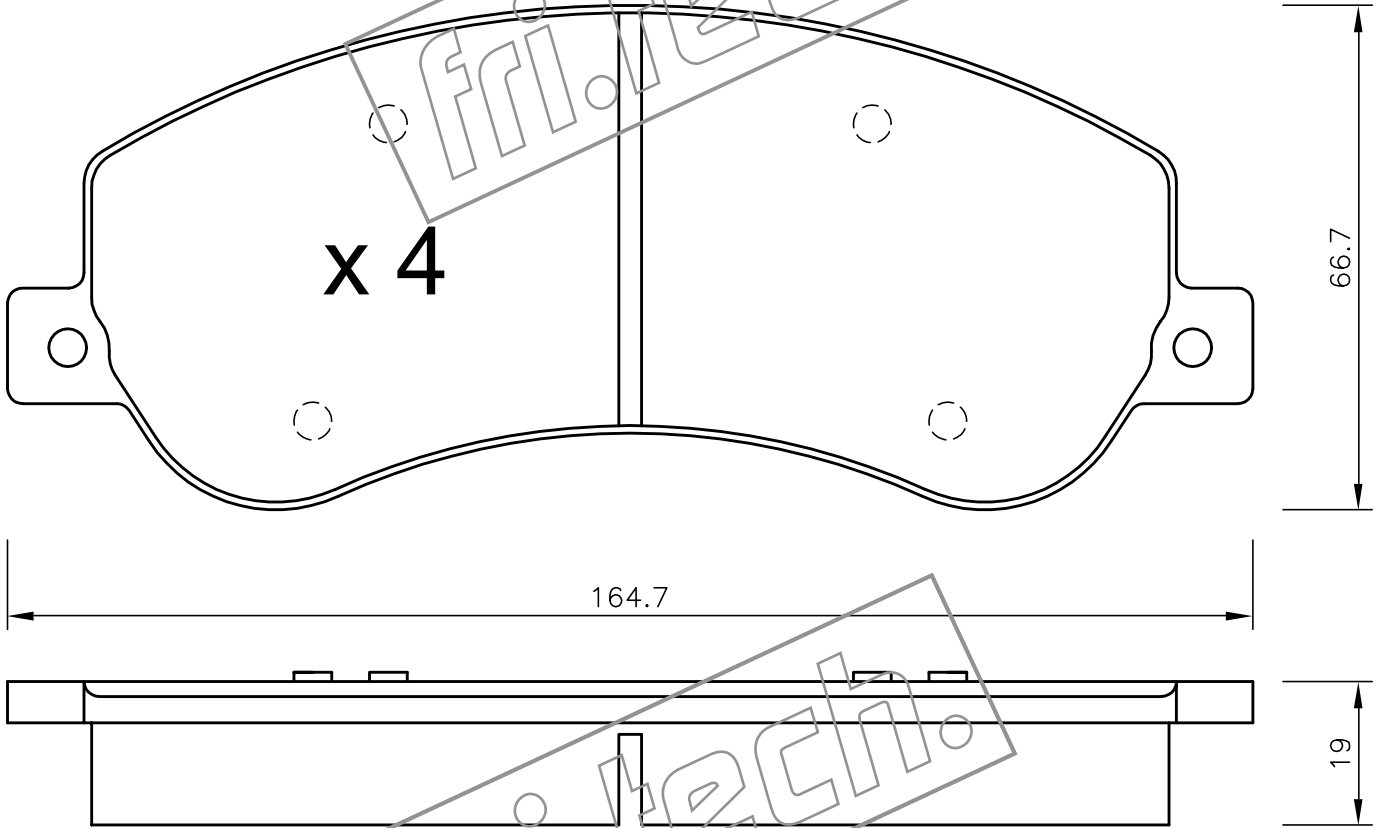

164.7

66.7

19

fri.tech.