

L = 280

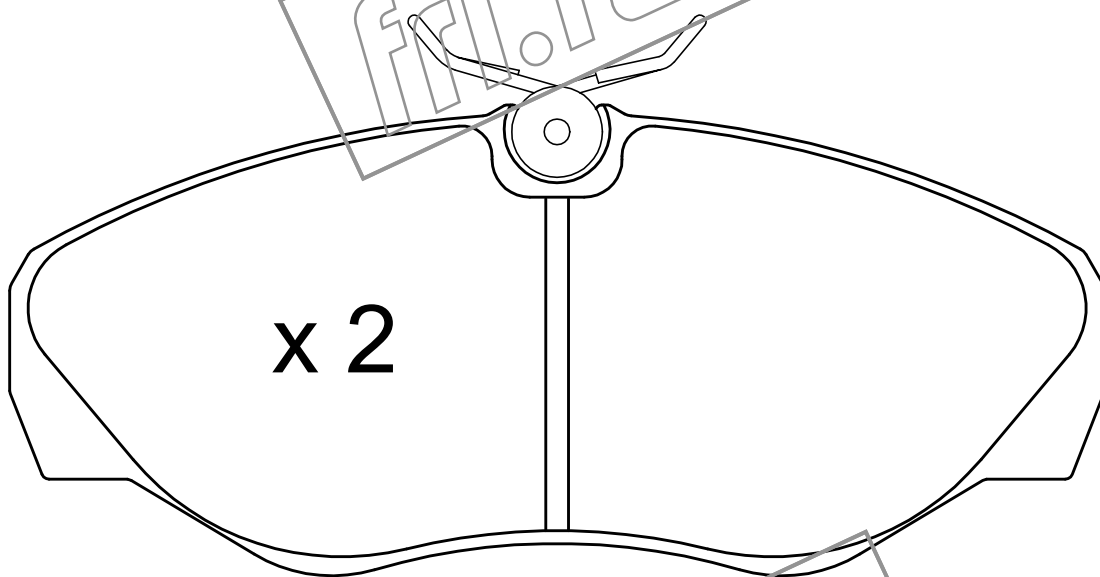

62.3

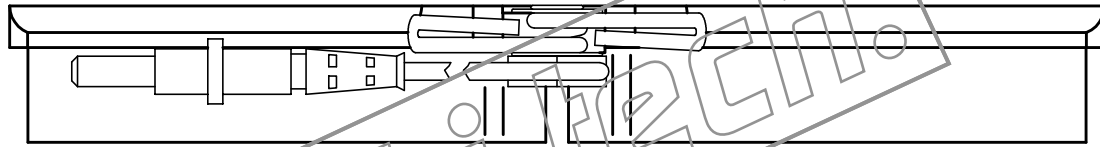
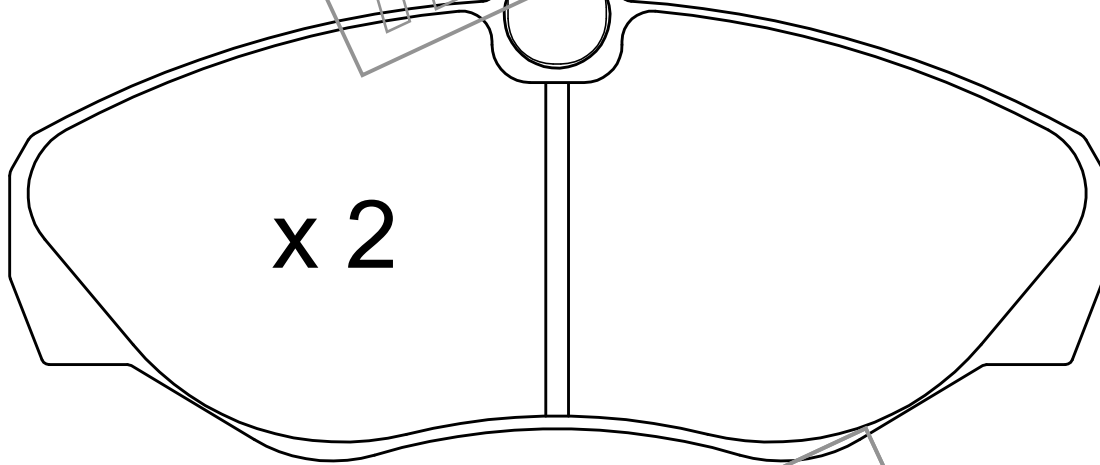
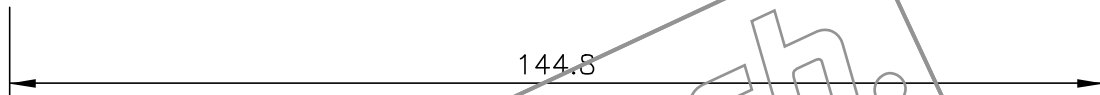

144.8

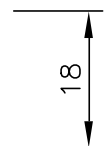
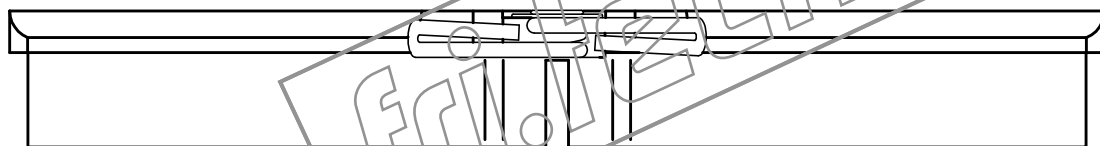

18