

x 1

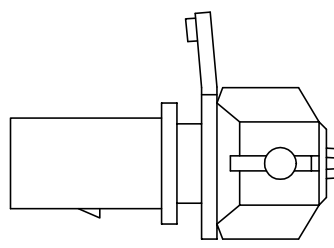

L = 205

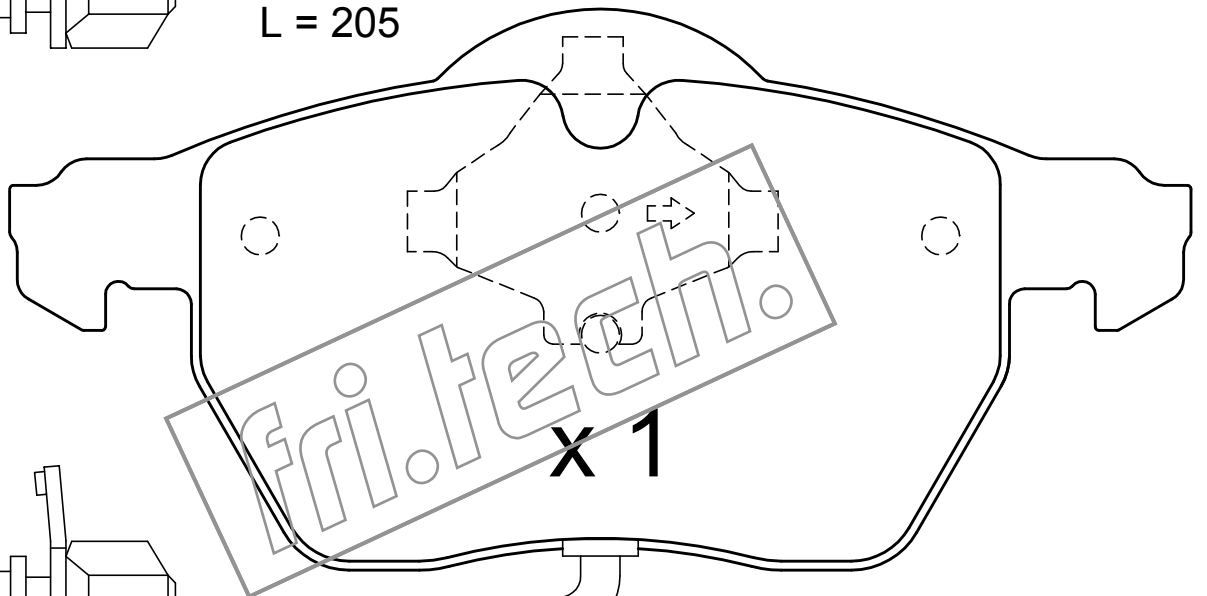

x 1

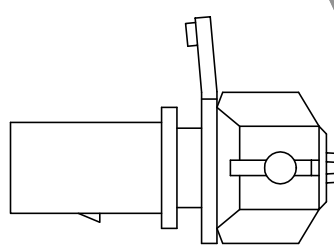

L = 205

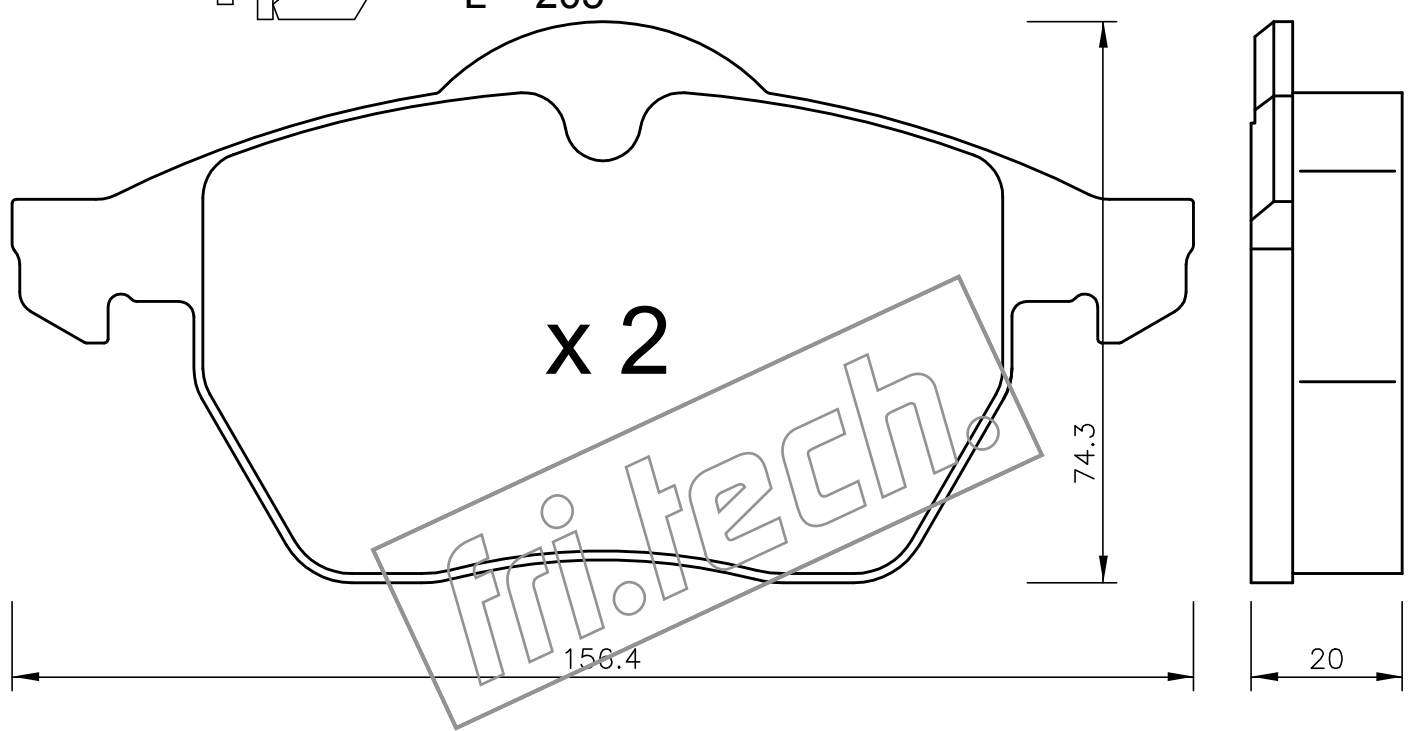

x 2

156.4

74.3

20