

x 2

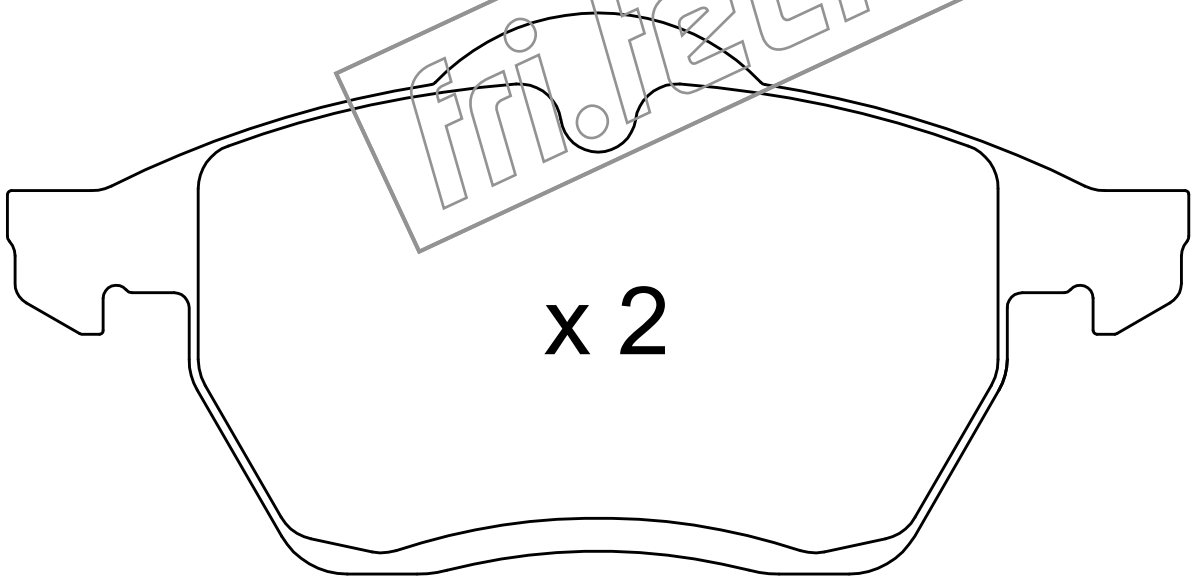

x 2

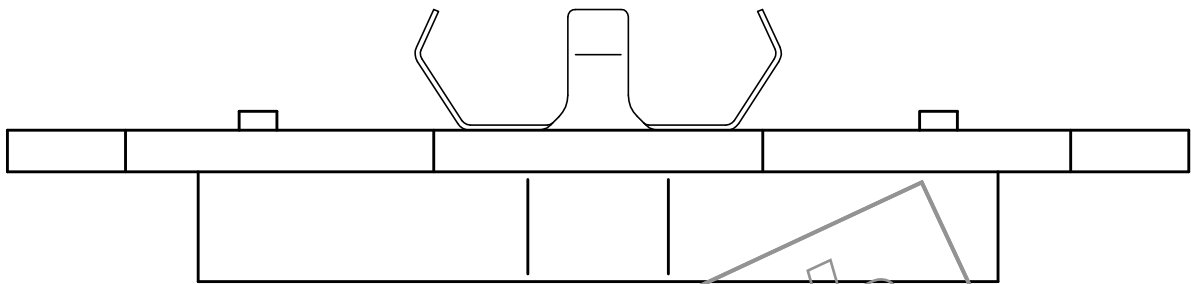
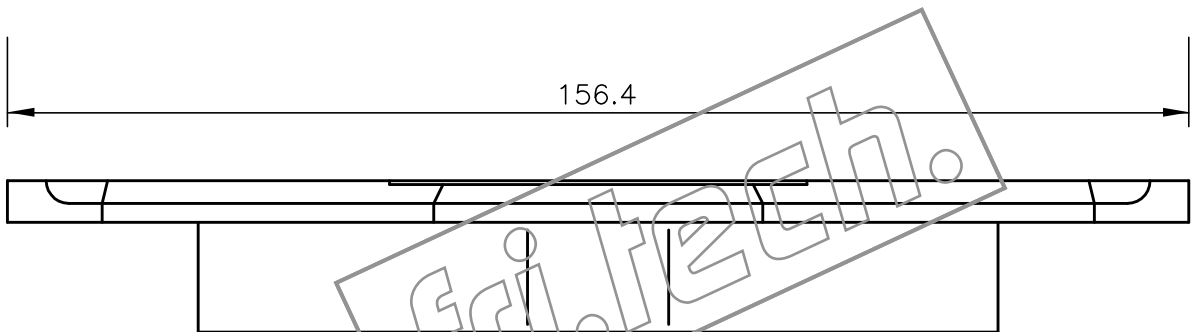

156.4

74.3

20