

L = 280

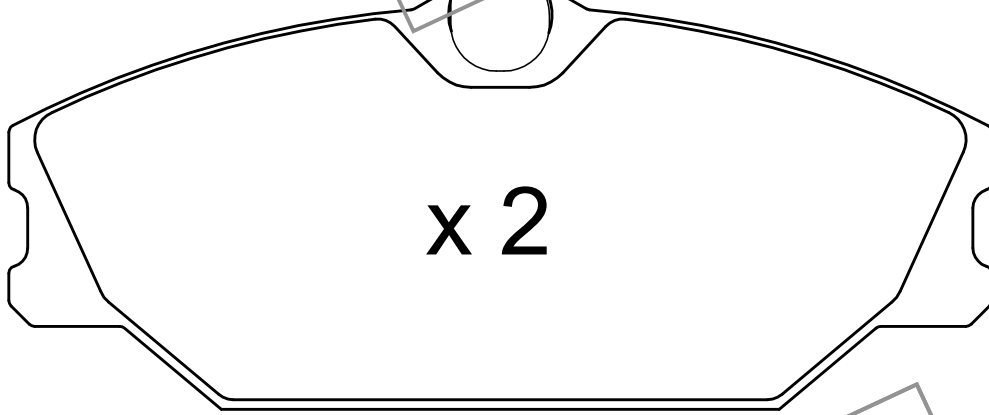

x 2

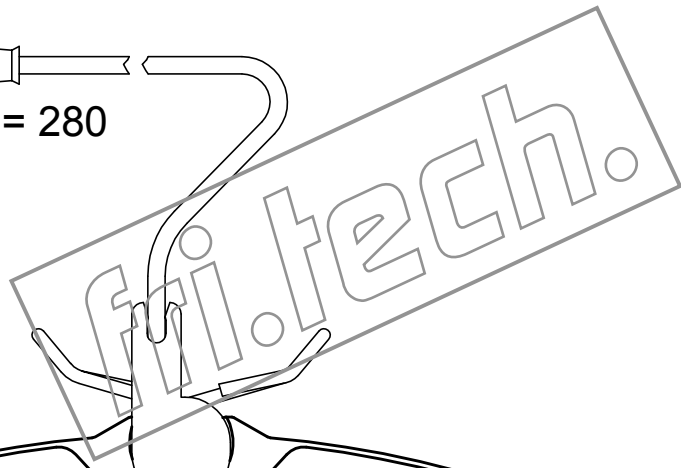
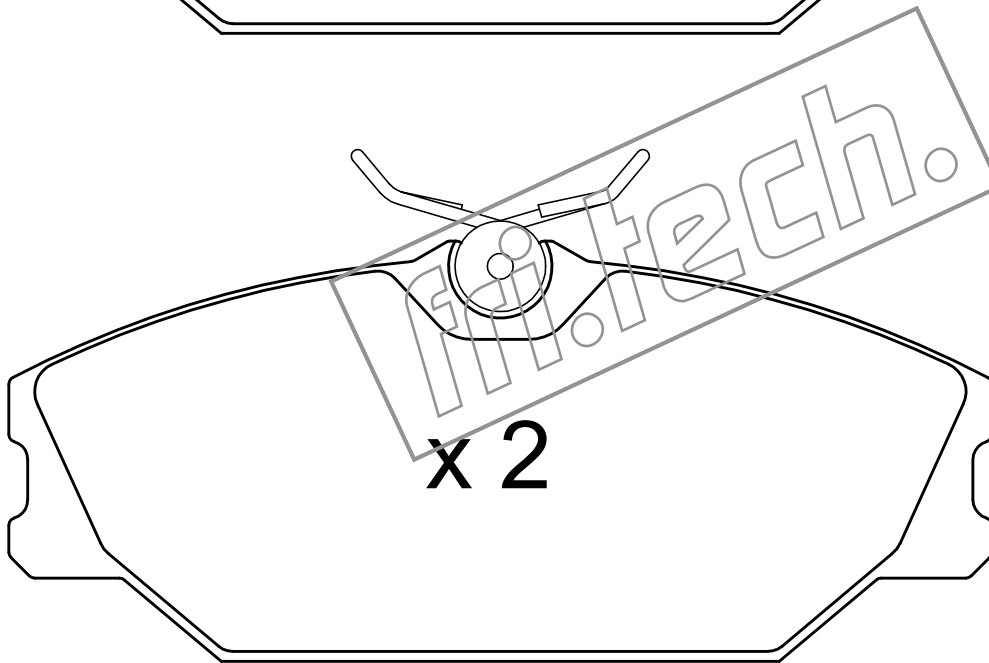

x 2

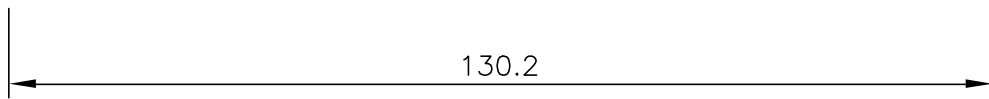

130.2

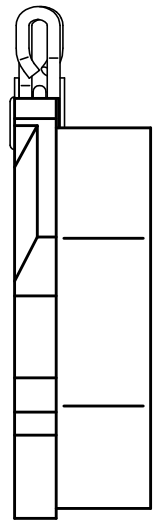
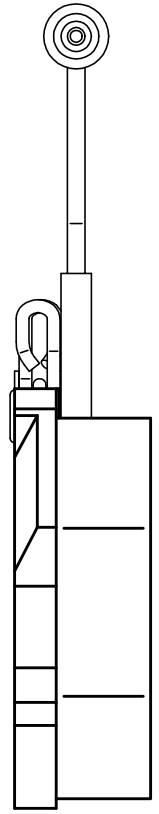

55.7

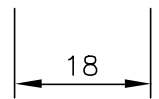

18

