

x 2

L = 315

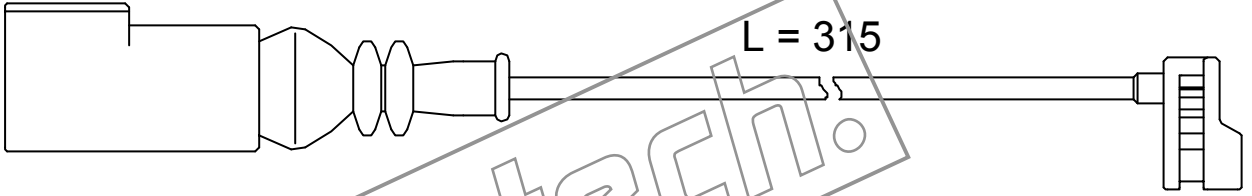

x 4

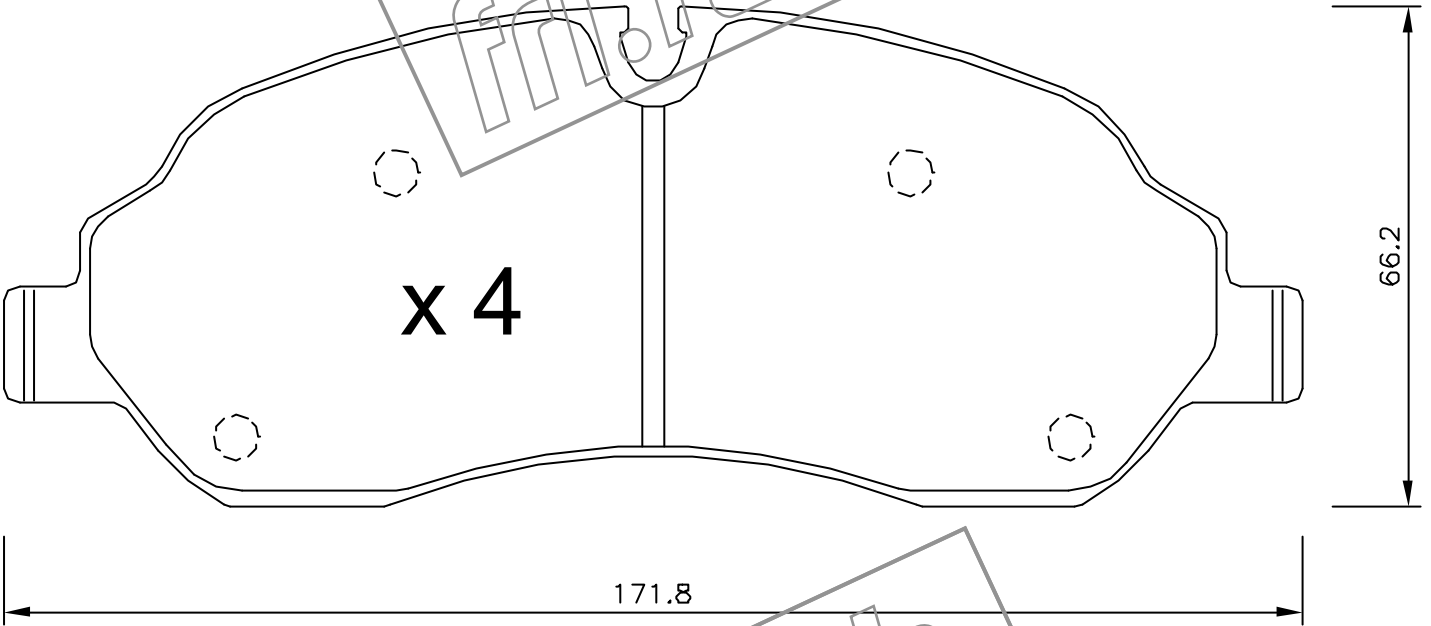

171.8

66.2



17

fri.tech.