

L = 215

fri.tech.

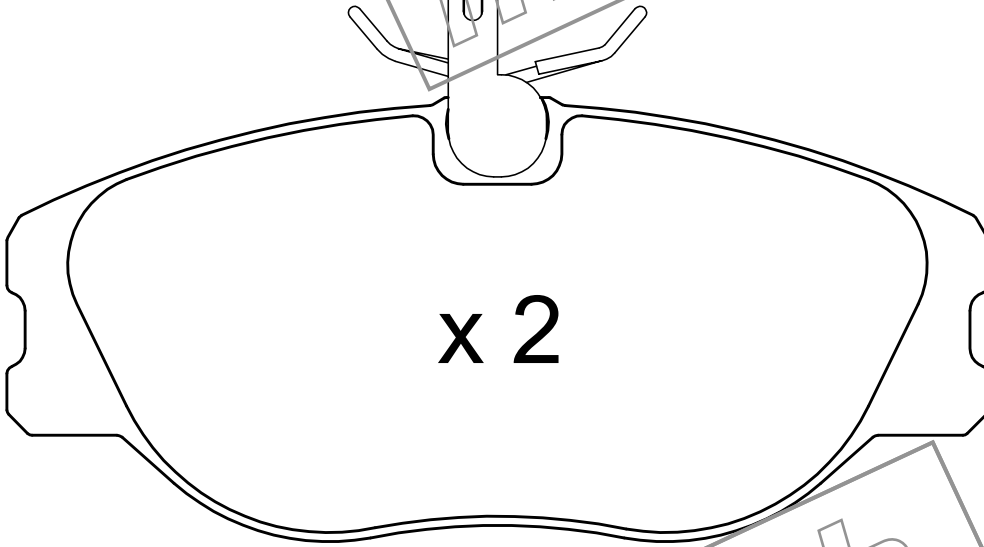

x 2

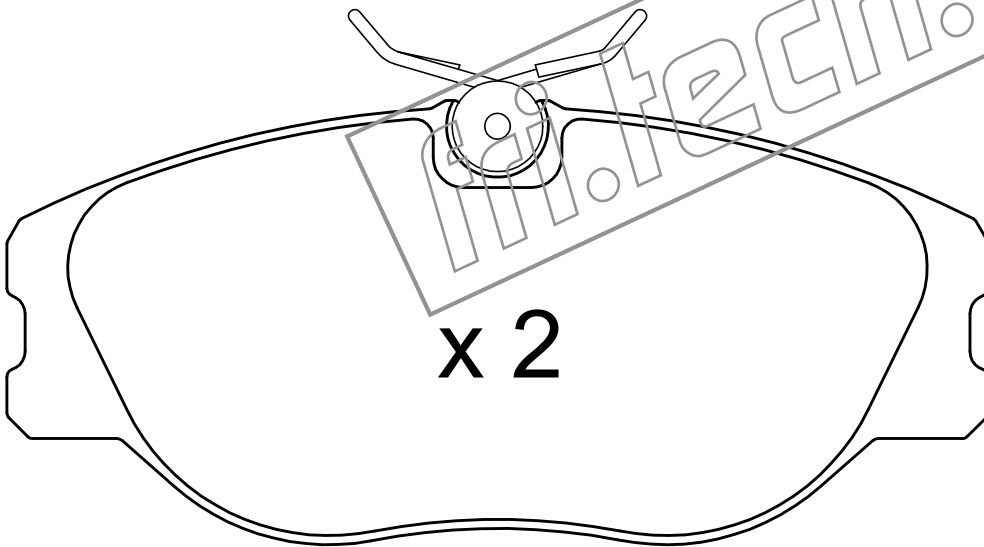

x 2

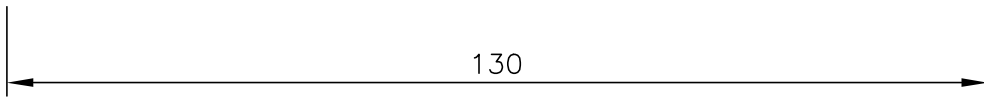

130

fri.tech.

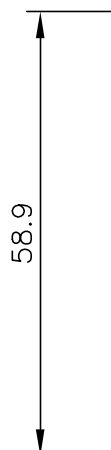
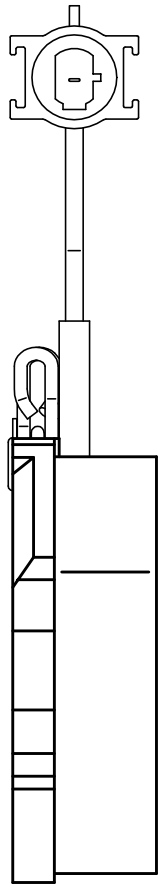

58.9

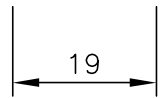
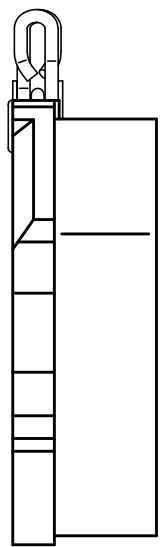

19