

L = 220

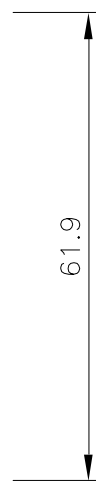

61.9

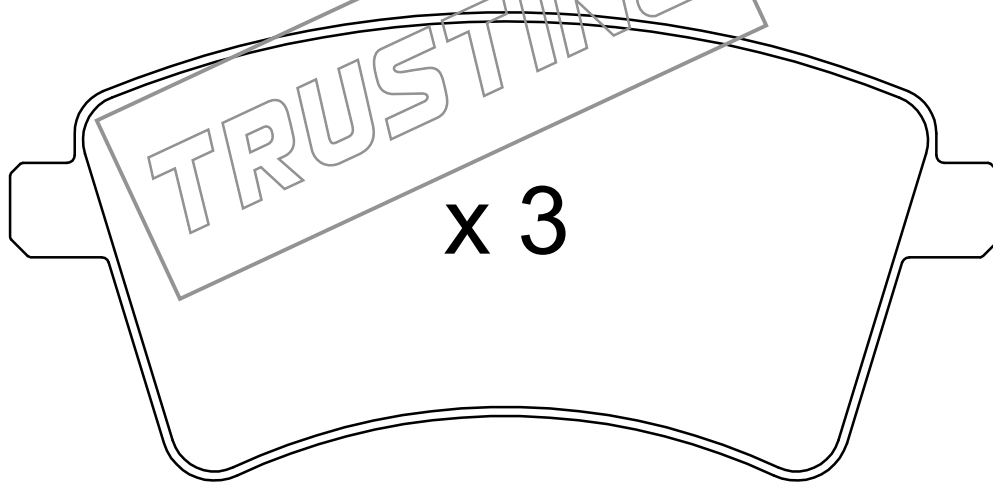
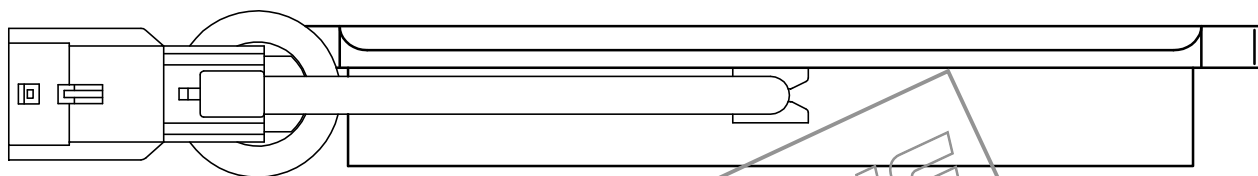
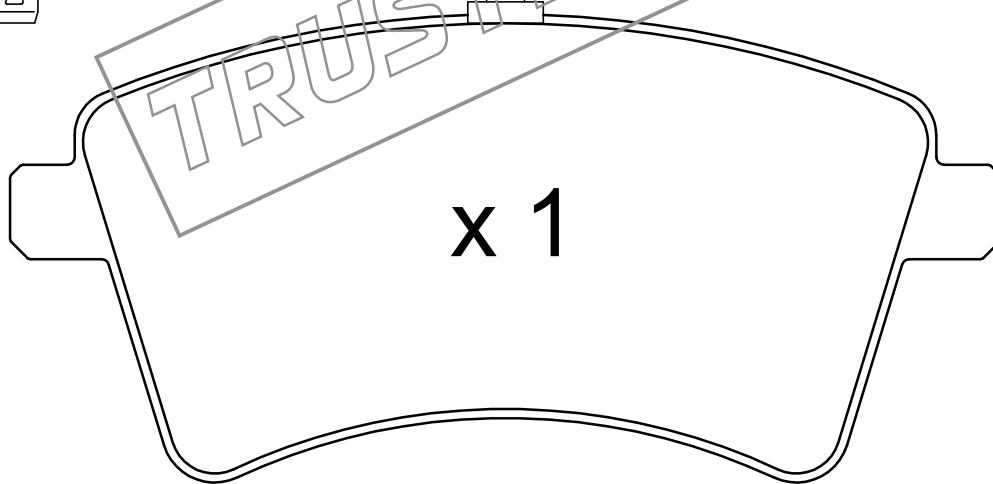
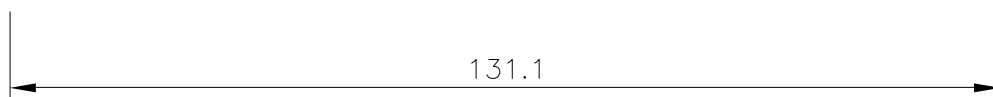

131.1

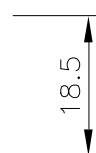
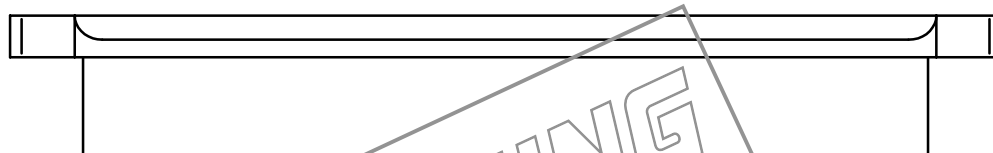

18.5

