

L = 280

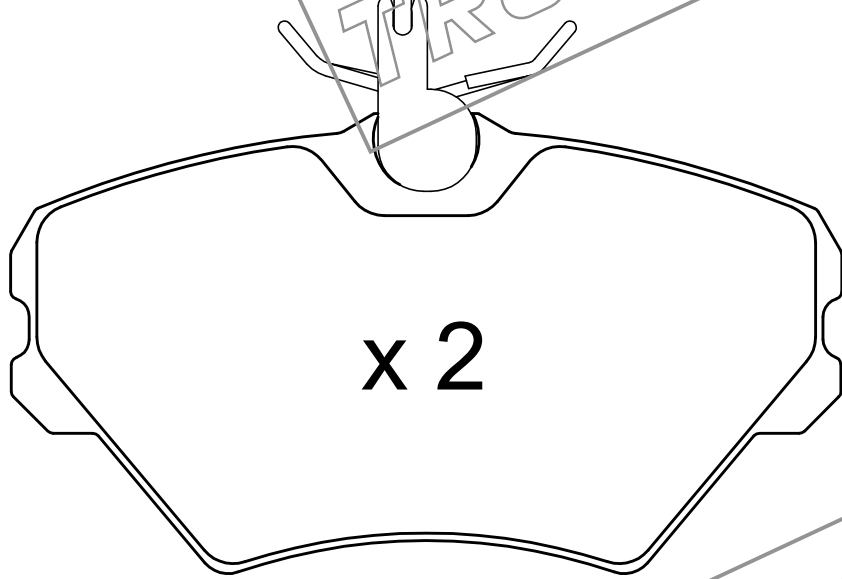

x 2

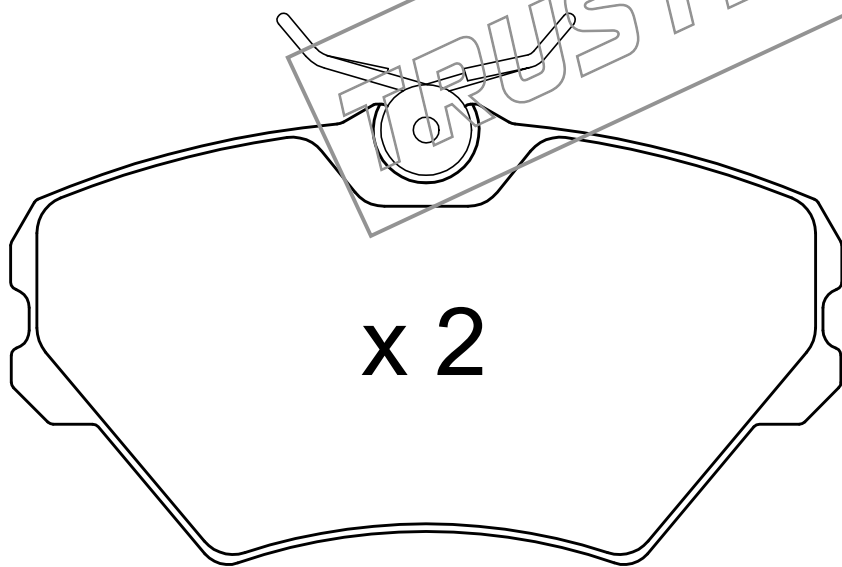
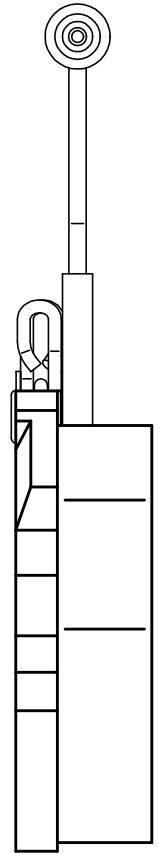

x 2

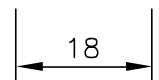
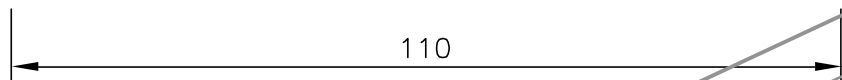
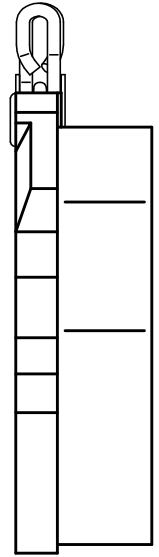
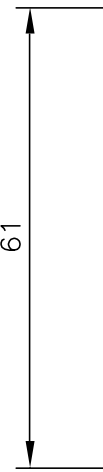

TRUSTING