

L = 190

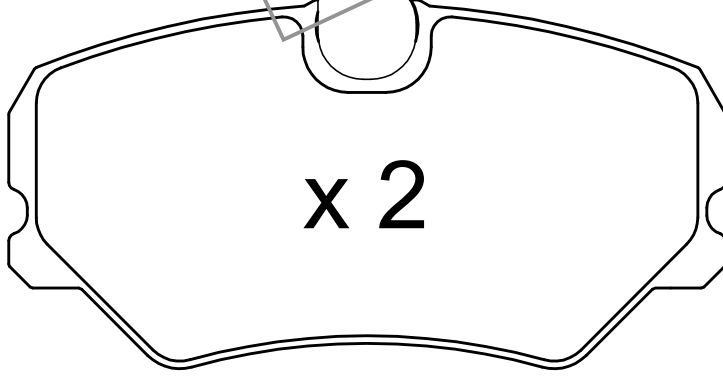

x 2

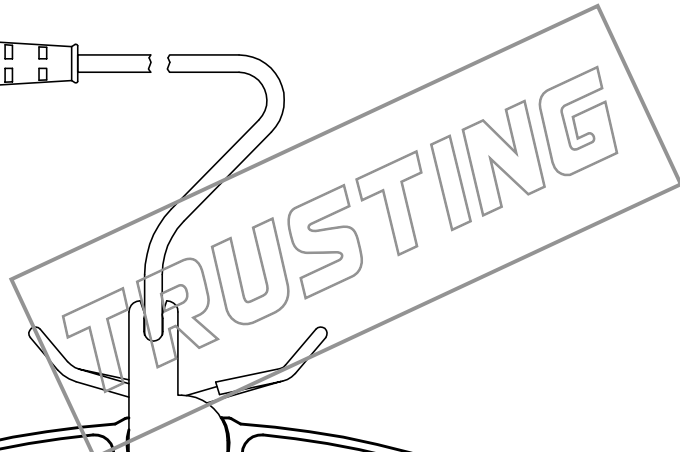
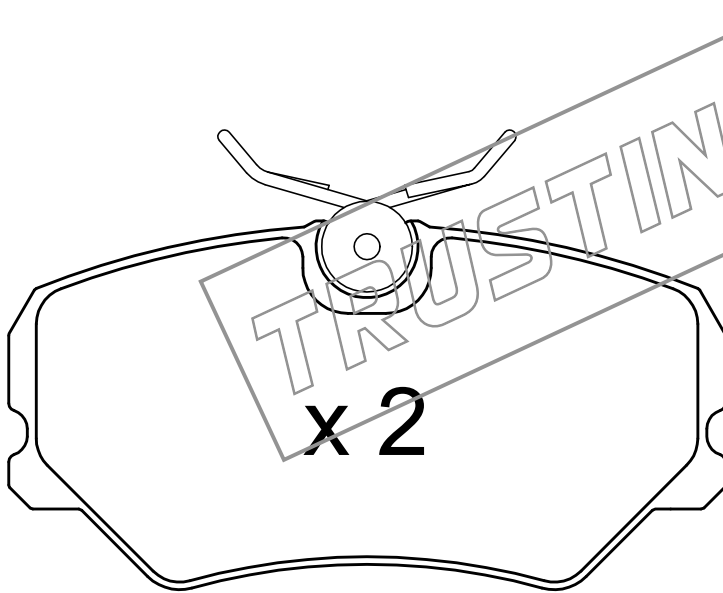
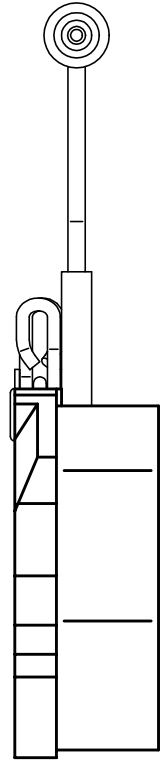

x 2

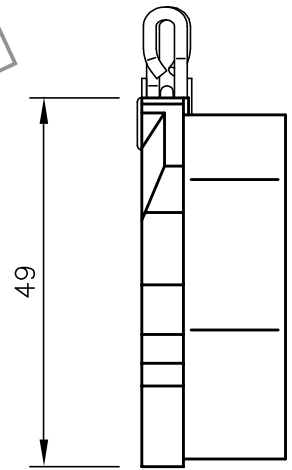

49

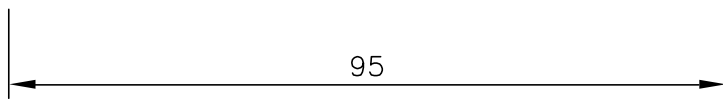

95

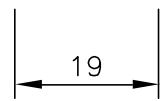

19

