

L = 800

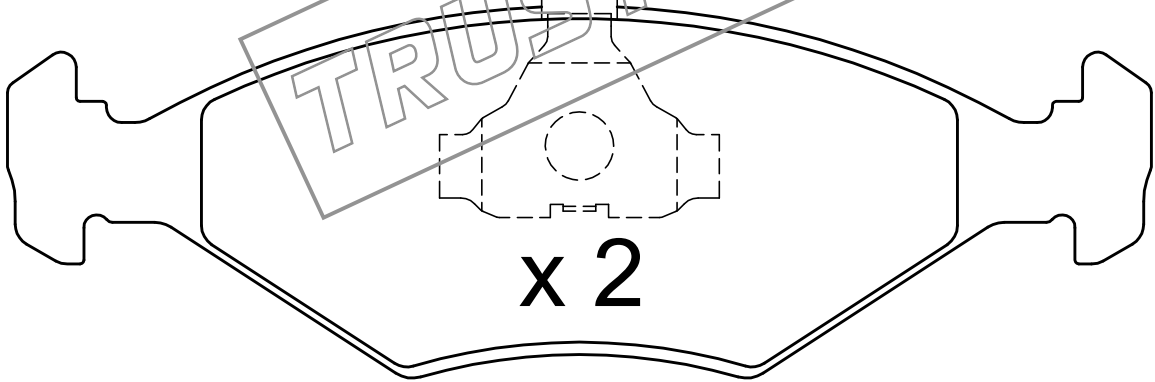

x 2

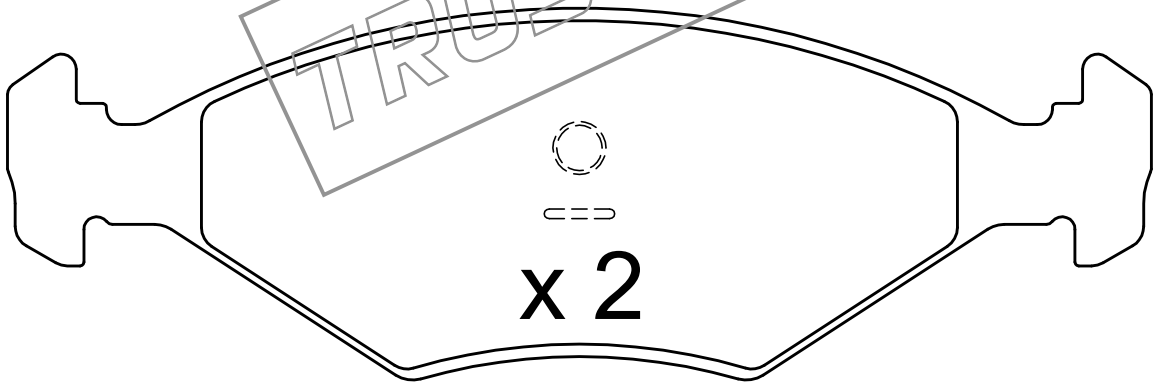
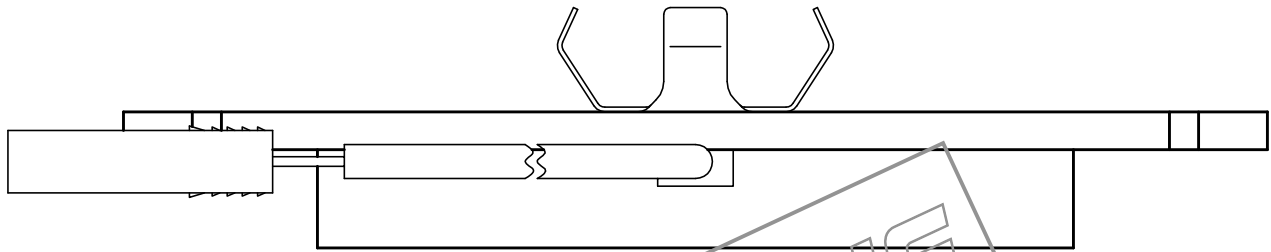

x 2

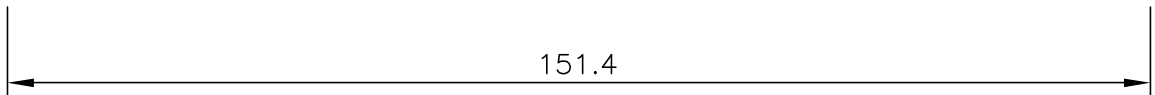

151.4

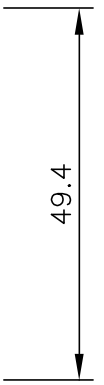

49.4

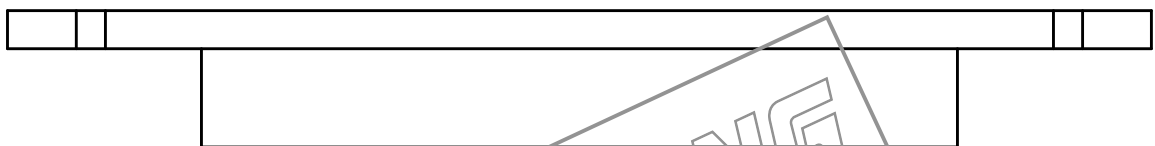

18

