

x 2 L = 215

x 2 L = 310

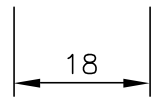
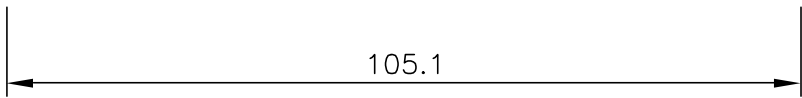
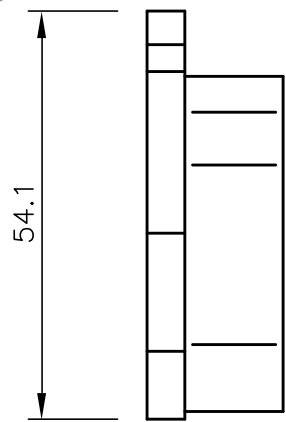
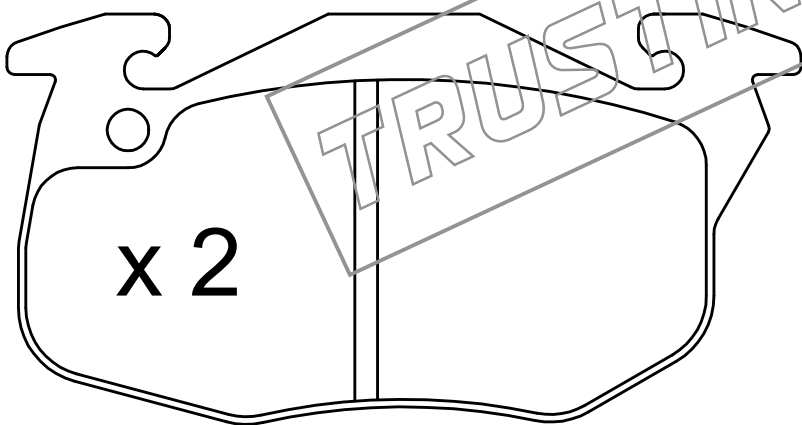
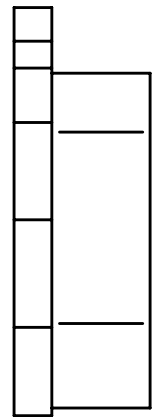
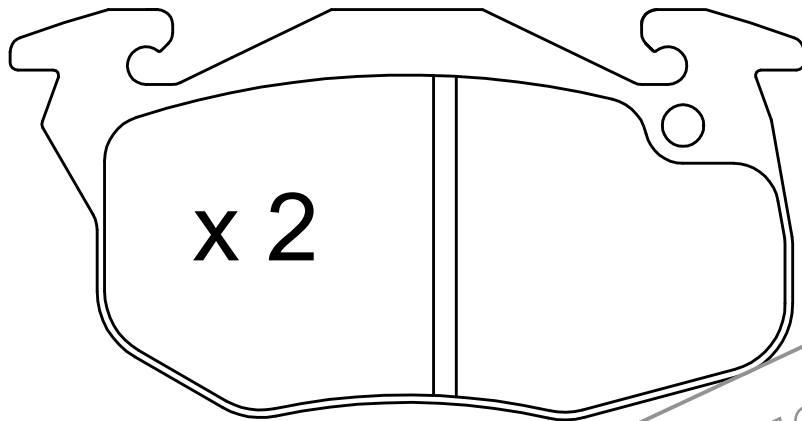

TRUSTING