

# Thule Rapid System 751

# > Instructions

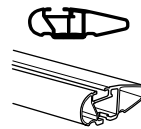

WingBar

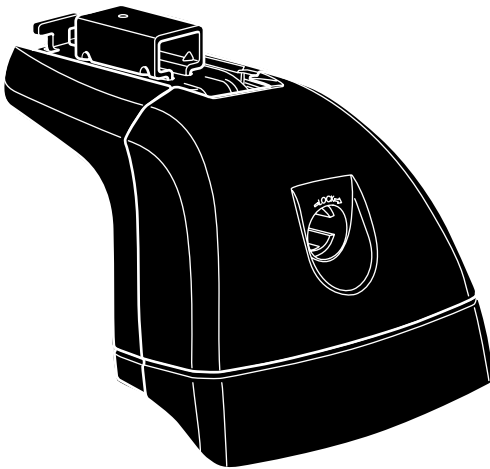
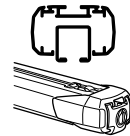

SlideBar

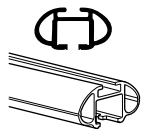

AeroBar

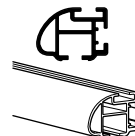

ProBar

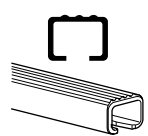

SquareBar



**CITY CRASH**

Complies with ISO norm

ISO 11154-E

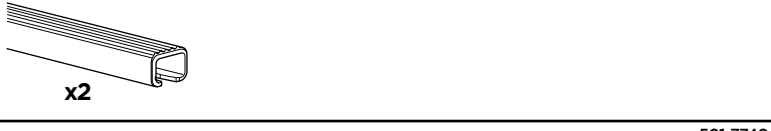
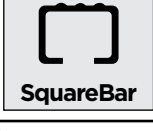
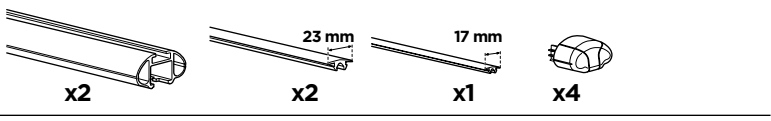
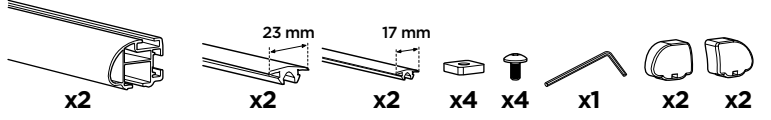
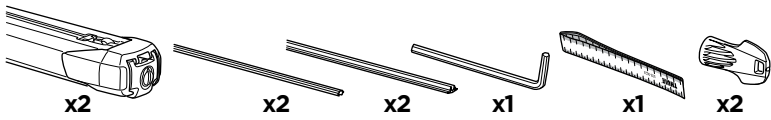
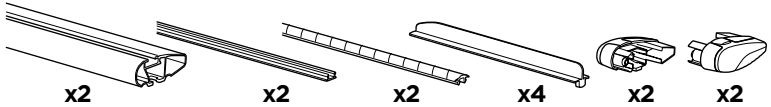
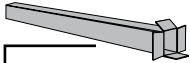
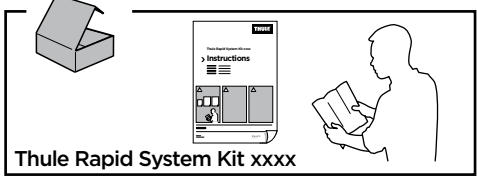
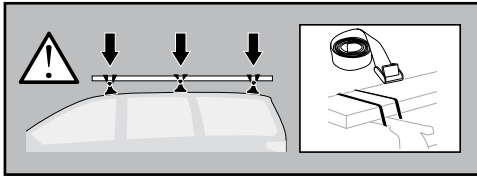
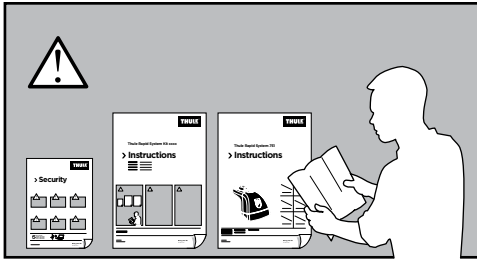
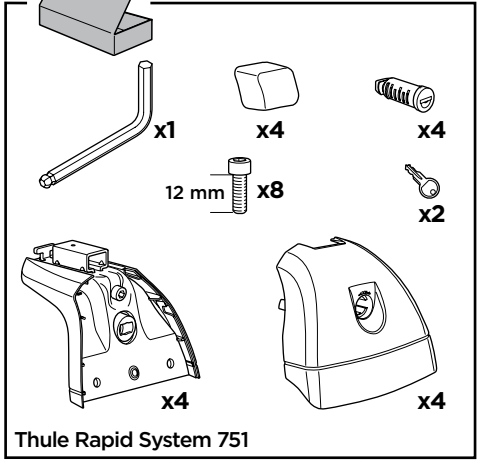
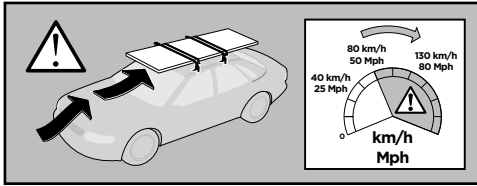

1

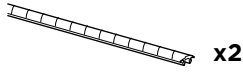

A

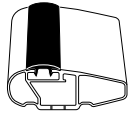
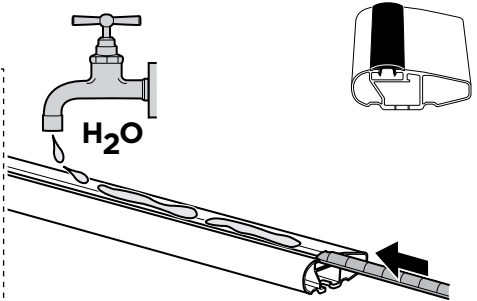
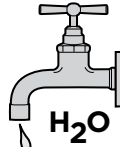
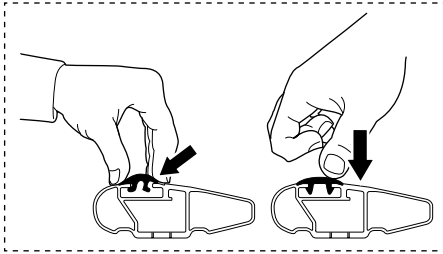

B

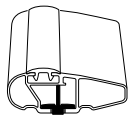
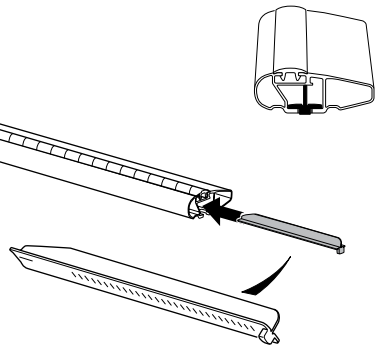
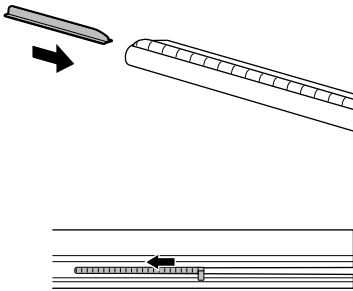

C

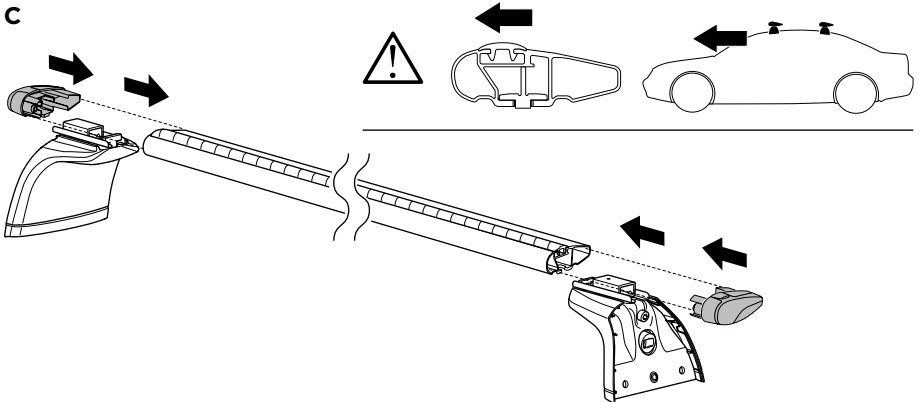

1



SlideBar

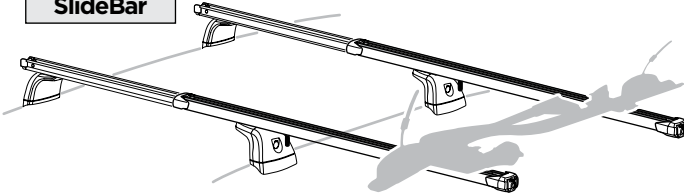

SlideBar  
891, 892, 893

instructions



THUJ



1



ProBar



x4



x2

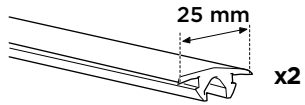

x2

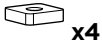

x4



x2



x1

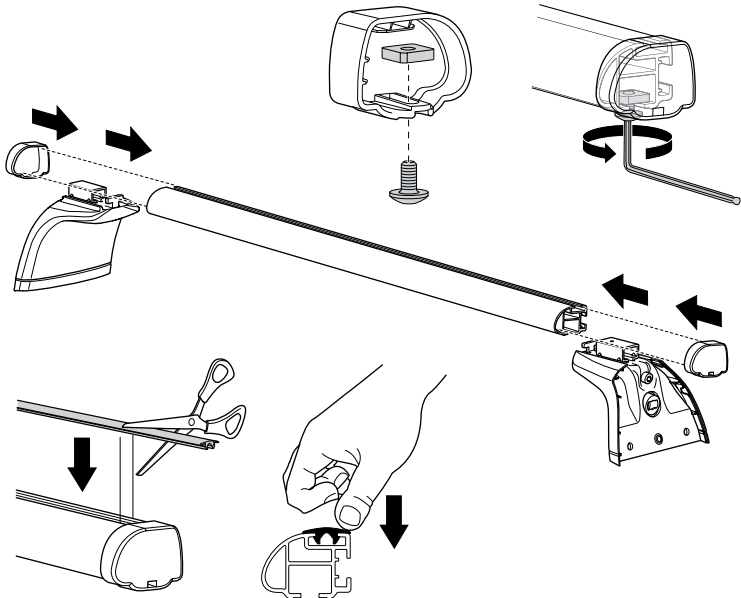

1



AeroBar

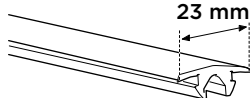

x2



x4

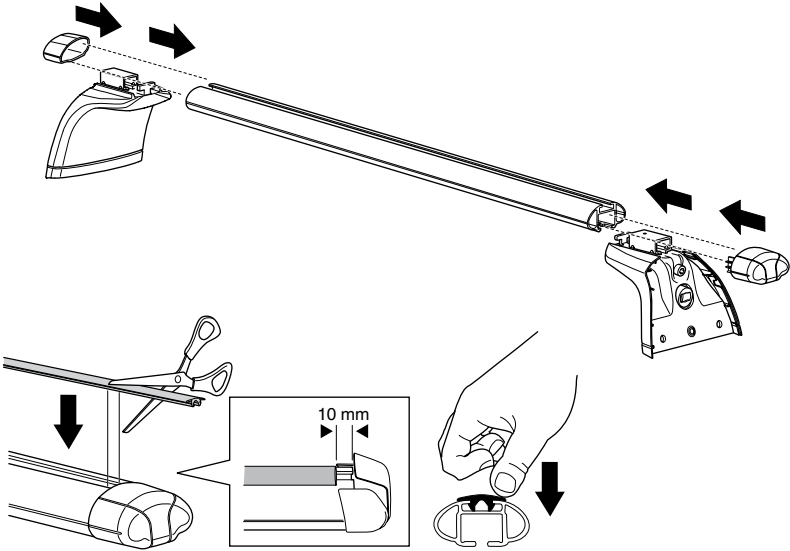

1



SquareBar

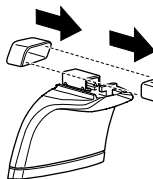

x4

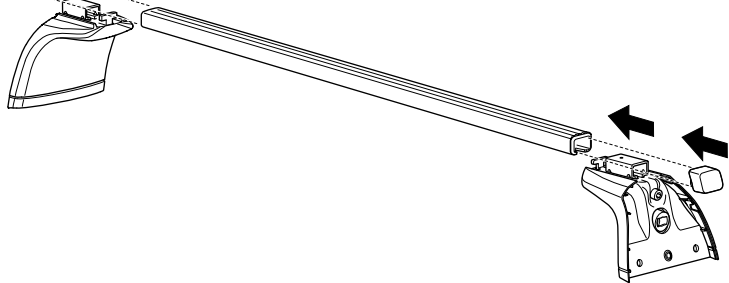

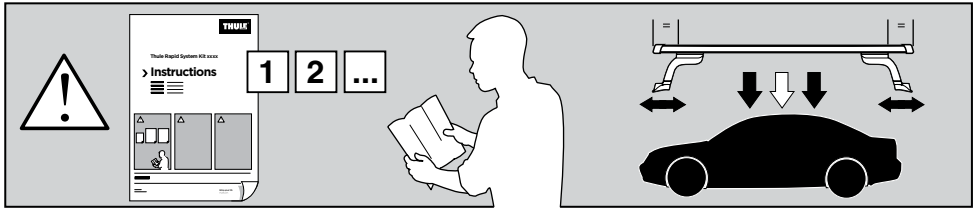

**EN IMPORTANT!** Move to KIT-manual and perform the car specific steps, before continuing with this instruction.

**DE WICHTIG!** Wechseln Sie zum KIT-Handbuch und führen Sie die fahrzeugspezifischen Schritte durch, bevor Sie mit dieser Anleitung fortfahren.

**FR IMPORTANT!** Avant de continuer ces instructions, passez au manuel du KIT et effectuez les étapes spécifiques au véhicule.

**NL BELANGRIJK!** Ga naar de KIT-handleiding en voer de specifieke stappen voor de auto uit voordat u verder gaat met deze instructie.

**IT IMPORTANTE!** Passare al Manuale KIT ed eseguire le fasi specifiche alla vettura, prima di proseguire con queste istruzioni.

**ES ¡IMPORTANTE!** Consulte el manual del KIT y realice los pasos específicos del coche antes de continuar con estas instrucciones.

**PT IMPORTANTE!** Avance para o manual do KIT e execute os passos específicos do automóvel, antes de continuar com esta instrução.

**SV VIKTIG!** Fortsätt med KIT-anvisningen och utför bilspecifika steg, fortsätt sedan med denna anvisningen.

**DK VIGTIG!** Tag brugsanvisningen til sættet, og noter de bilspecifikke oplysninger, før du går videre med denne vejledning.

**NE VIKTIG!** Gå til KIT-håndboken og gjør de bilspecifikke trinnene før du fortsetter med denne instruksjonen.

**FI TÄRKEÄ!** Siirry SARJA-oppaaseen ja tee auto-kohtaiset toimenpiteet, ennen kuin jatkat tätä ohjetta eteenpäin.

**ET NB!** Avage komplekti (KIT) juhend ja tehke autole nõutavad tööd ning alles seejärel jätkake käesolevate juhiste kohaselt.

**LV SVARĪGI!** Pirms turpināt izpildīt šajā pamācībā sniegtos norādījumus, skatiet KOMPLEKTA rokasgrāmatu un veiciet ar automobili saistītās darbības.

**LT SVARBU!** Prieš toliau vykdydami šią instrukciją pereikite prie KIT vadovo ir atlikite autobusui skirtus veiksmus.

**PL WAŻNE!** Przed kontynuowaniem, wykonać czynności określone dla konkretnego samochodu w instrukcji KIT.

**RU ВАЖНО!** Обратитесь к руководству по эксплуатации комплекта и проделайте специфические для автомобиля шаги, прежде чем продолжить выполнять требования настоящей инструкции.

**UK ВАЖЛИВО!** Зверніться до посібника з використанням КОМПЛЕКТУ та виконайте специфічні для автомобіля кроки, перш ніж продовжити виконувати вимоги цієї інструкції.

**BG ВАЖНО!** Продължете с ръководството за употреба на КОМПЛЕКТА и изпълнете специфичните за автомобила стъпки преди да продължите с тази инструкция.

**CS DŮLEŽITÉ!** Předtím, než budete pokračovat s těmito pokyny, podívejte se na návod k SADĚ a proveďte kroky specifické pro vozidlo.

**SK DÔLEŽITÉ!** Predtým, než budete pokračovať s týmito pokynmi, sa pozrite na návod k SÚPRAVE a vykonajte kroky špecifické pre vozidlo.

**SL POMEMBNO!** Preden nadaljujete s tem navodilom, pojdite na priročnik kompleta in opravite korake, specifične za vaše vozilo.

**HR/BiH VAŽNO!** Prije nego nastavite s ovim uputama, prebacite se na priručnik seta i izvršite korake koje se odnose na automobil.

**RO IMPORTANT!** Consultați manualul KIT și efectuați etapele specifice autoturismului înainte de a continua cu această instrucțiune.

**HU FONTOS!** A hajtsa végre a készlet kézikönyvében található, az autóra vonatkozó lépéseket, mielőtt ezzel az útmutatással folytatja.

**EL ΣΗΜΑΝΤΙΚΟ!** Μεταβείτε στο εγχειρίδιο του KIT και εκτελέστε τα ειδικά βήματα για το αυτοκίνητο, πριν να συνεχίσετε με αυτήν την οδηγία.

**TR ÖNEMLİ!** Bu talimatla devam etmeden önce KIT kilavuzuna gidin ve araca özel adımları gerçekleştirin.

**AR هام!** انتقل إلى دليل العمل KIT وقم بإجراء الخطوات الخاصة بالسيارة قبل متابعة التعليمات.

**HE חשוב!** עבור למדריך הקיט ובצע מכונות את השלבים המפורטים בו לפני המשך ביצוע ההראות אלה.

**ZH 重要信息!** 在继续此说明之前, 先移到工具箱手册, 然后执行特定步骤。

**JA 重要!** この取付説明書を続ける前にKITマニュアルに行き、車固有のステップを行ってください。

**KO 중요!** 이 지침을 계속 진행하기 전에 KIT 설명서로 이동하여 해당 차량에만 해당하는 단계를 수행하십시오.

**TH สำคัญ!** ย้ายไปที่คู่มือ KIT และปฏิบัติตามขั้นตอนเฉพาะของรถยนต์ ก่อนดำเนินการตามคำแนะนำ

2

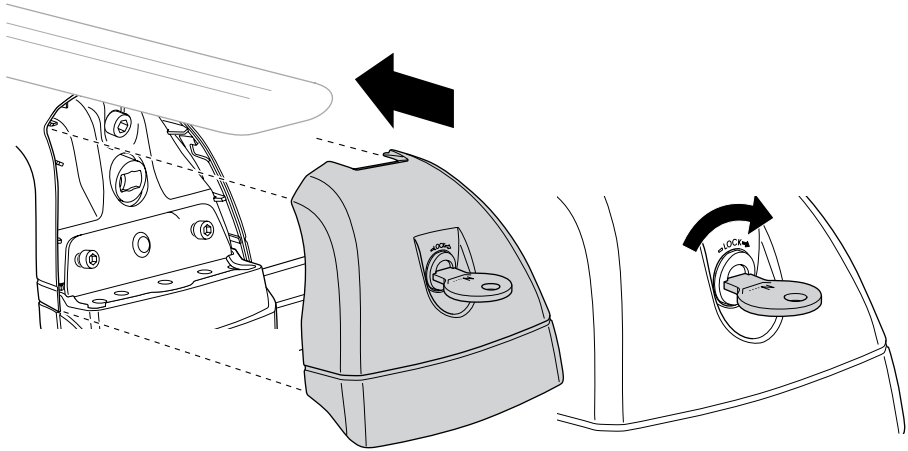
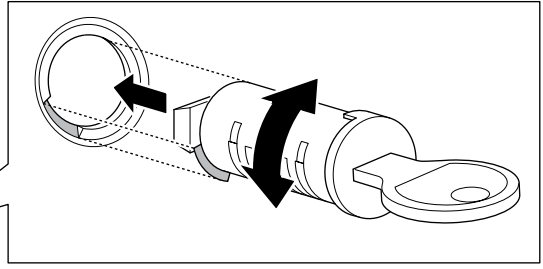
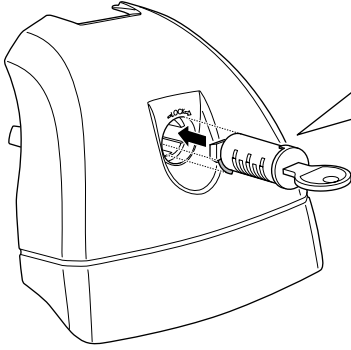

3

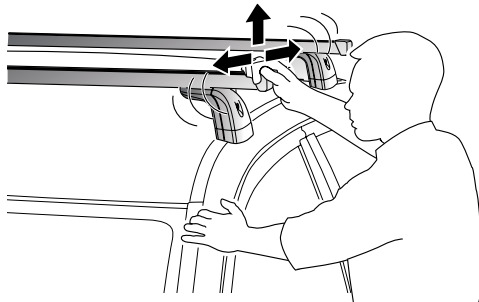

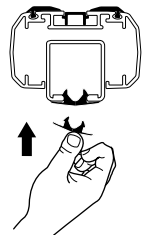
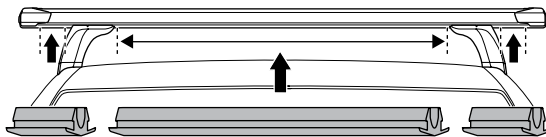
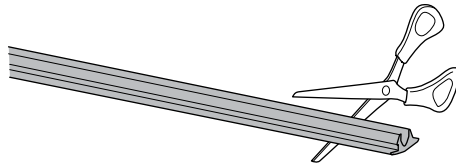
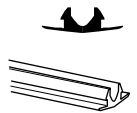
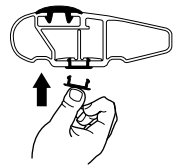
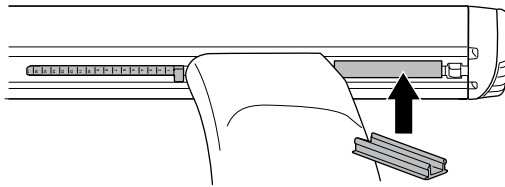
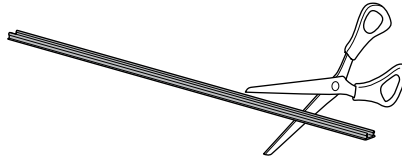
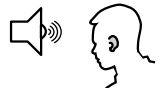



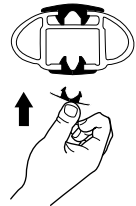
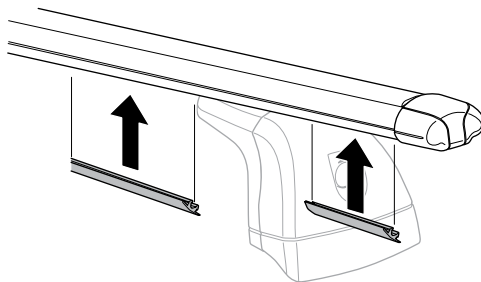
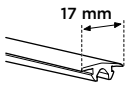
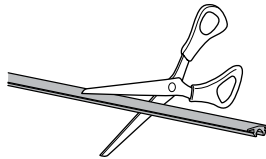
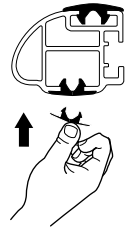
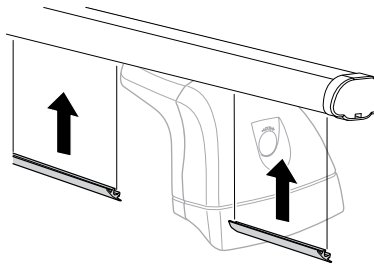
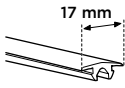
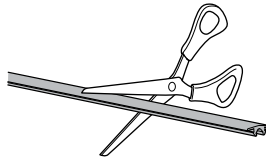
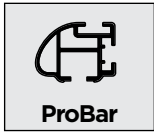
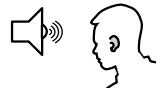



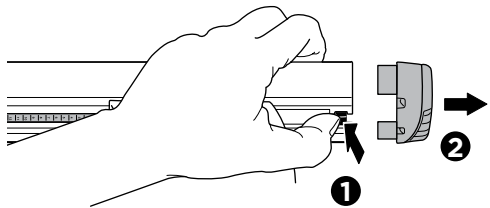
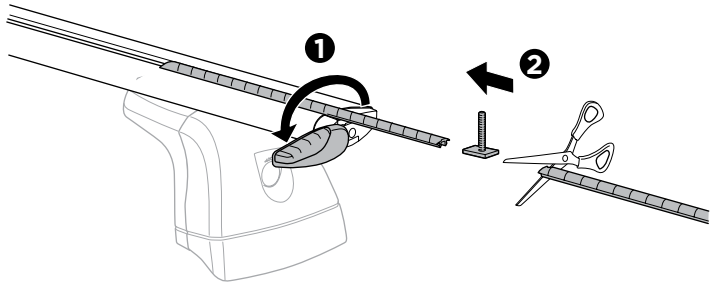

  
**WingBar**



  
**SlideBar**

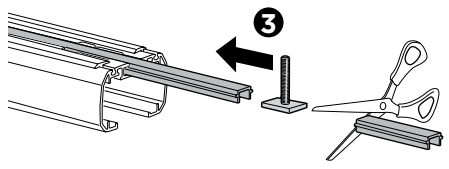
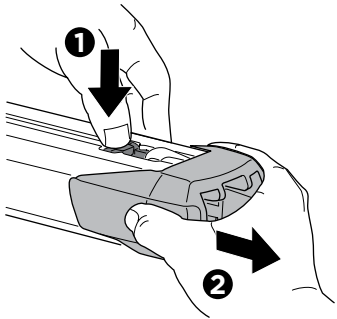

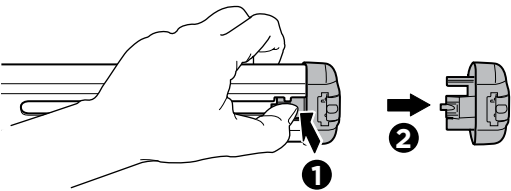
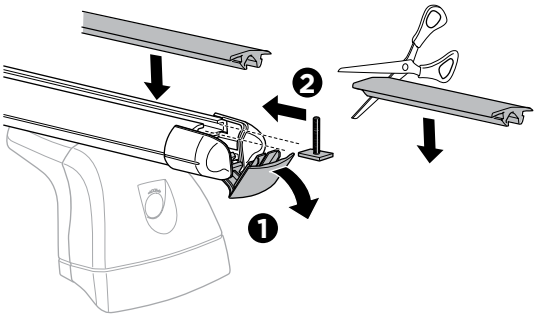
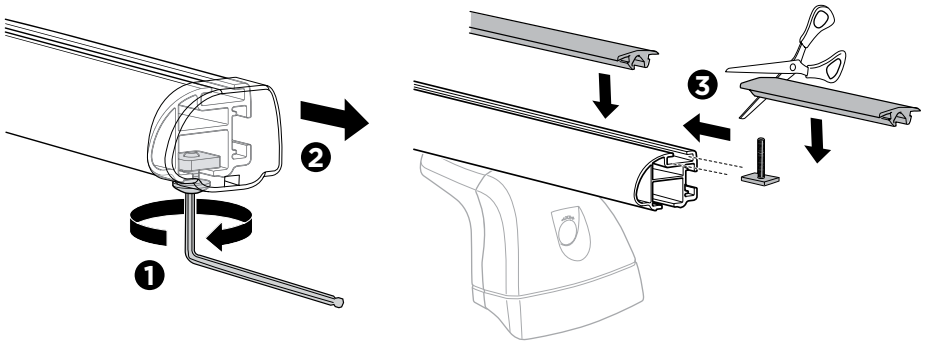

i

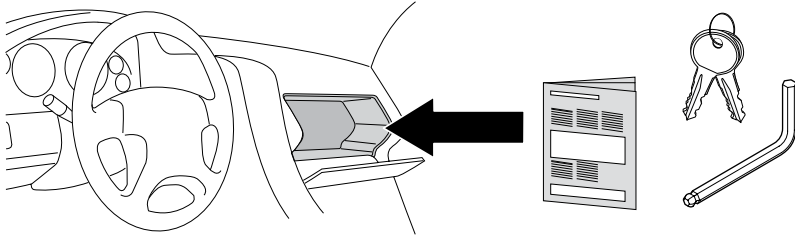

## Thule One-Key System

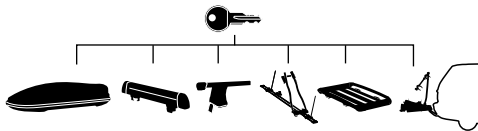

**544**  (x4)

**596**  (x6)

**588**  (x8)

**452**  (x12)

 Thule Sweden AB, Box 69, 330 33 Hillerstorp, SWEDEN

 [info@thule.com](mailto:info@thule.com)

 [www.thule.com](http://www.thule.com)