

Einbauanleitung Elektrosatz  
Anhängervorrichtung mit 12-N Steckdose  
lt. DIN/ISO Norm 1724

Instructions de montage du faisceau  
électrique pour crochet d'attelage  
conforme à la norme  
DIN/ISO 1724 prise 12-N

Fitting instructions electric wiringkit  
towbar with 12-N socket up to  
DIN/ISO norm 1724

Montage-handleiding elektrokabelset voor  
trekhaak met 12-N contactdoos  
vlgs. DIN/ISO norm 1724

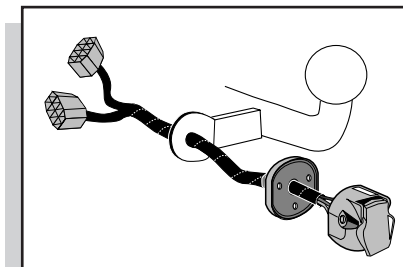

SUZUKI WAGON R+ 2000-  
OPEL AGILA 2000-

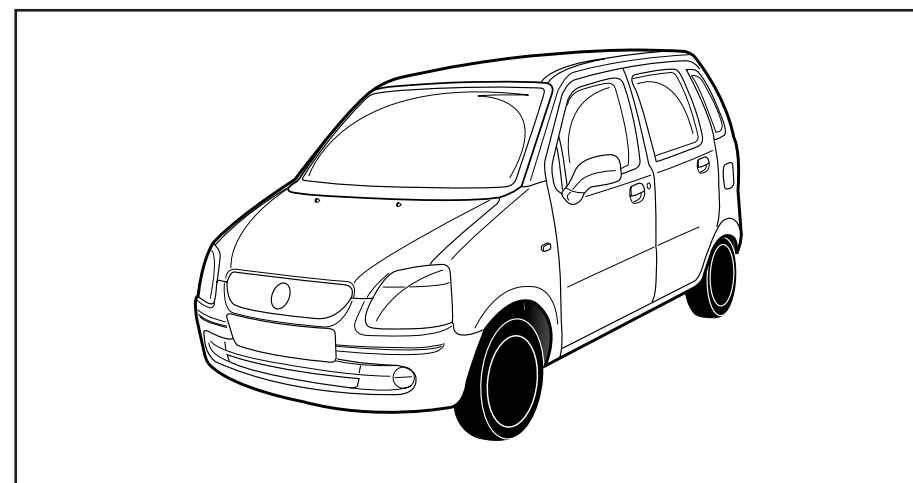

Bestel Nr.: SZ-008-BL

\* Teilliste

\* Liste de pieces

\* Part list

\* Onderdelenlijst

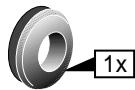
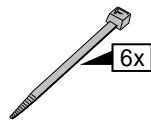
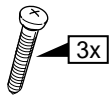
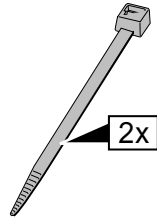
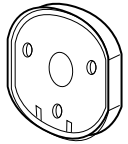
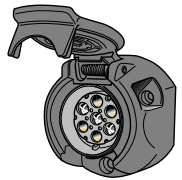
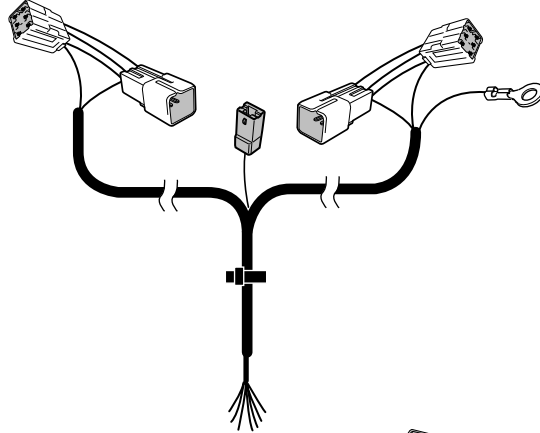
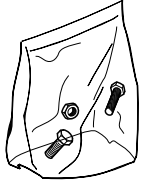
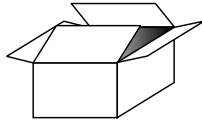

10

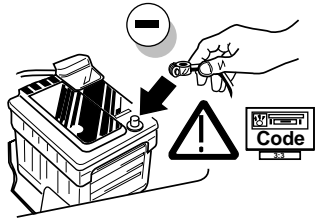

11

**FUNKTIONEN KONTROLLIEREN !**  
**CONTRÔLER LES FONCTIONS !**  
**CHECK FUNCTIONS !**  
**CONTROLEER FUNCTIES !**

1

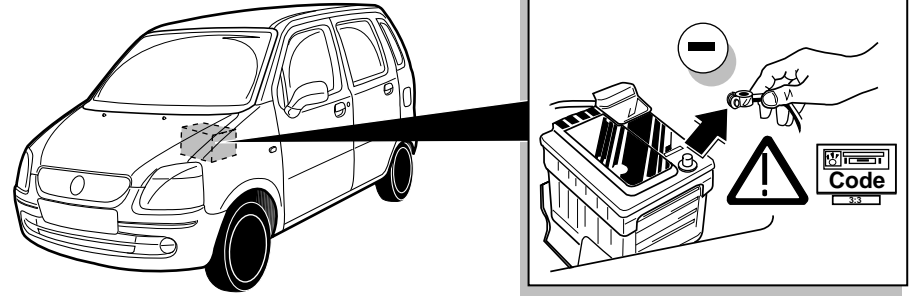

12

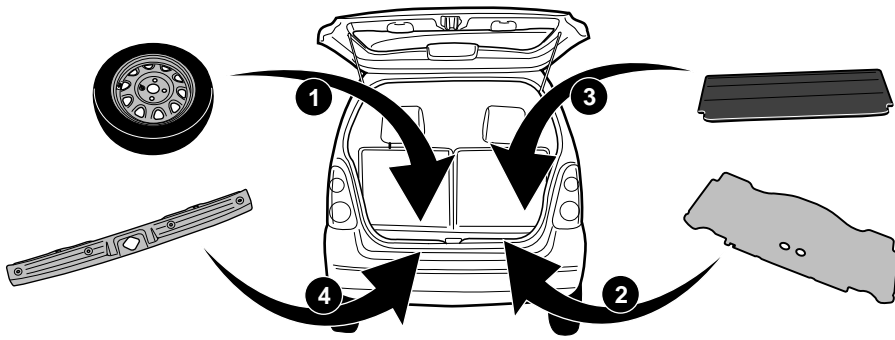

2

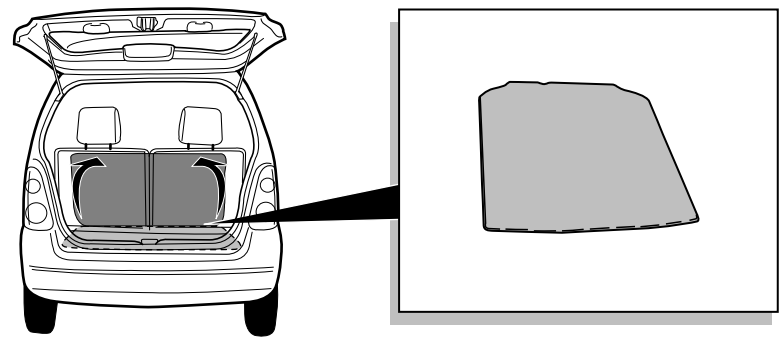

13

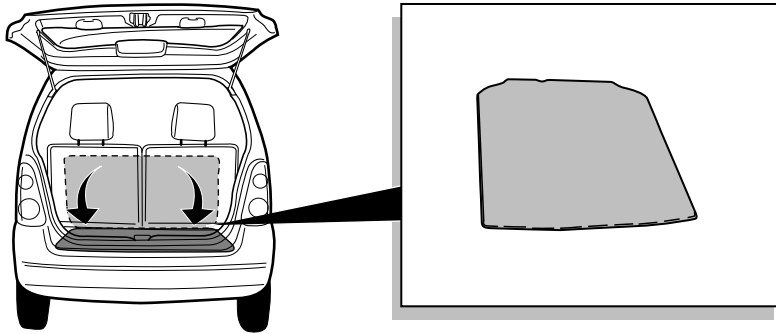

3

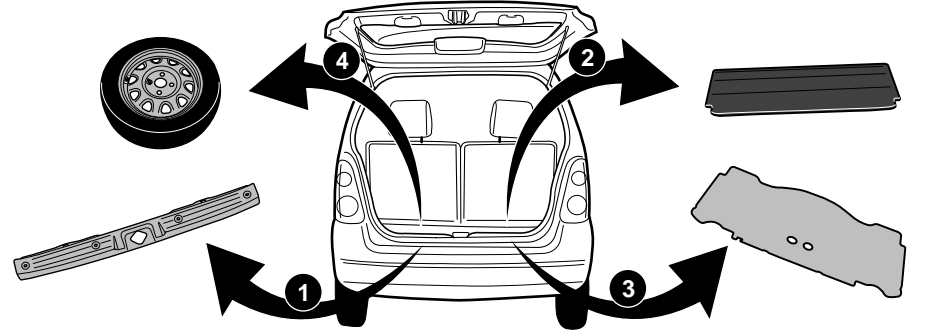

4

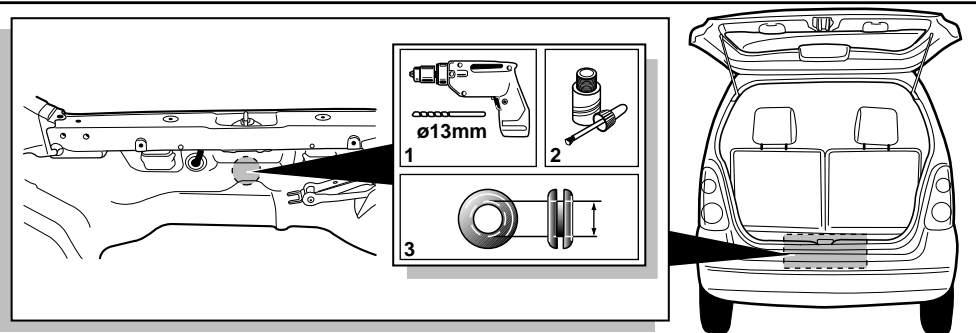

**INFO**

- D** Dit is een voorbereiding voor de achteruitrijlamp, en deze kan aangesloten worden op een 12S uitbreidingsset. (Engeland)
- D** This is a preparation for the reverse light and can be connected to a 12S extension kit.
- D** Dies ist eine Vorbereitung für die Rückfahrleuchte und kann an einem 12S Erweiterungssatz angeschlossen werden. (England)

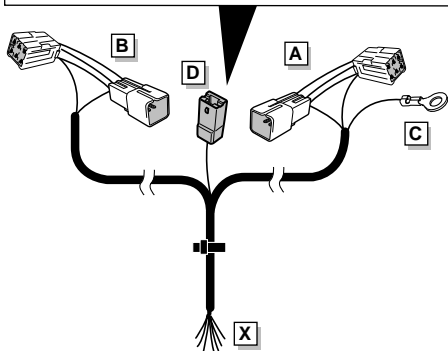

**ROUTING**

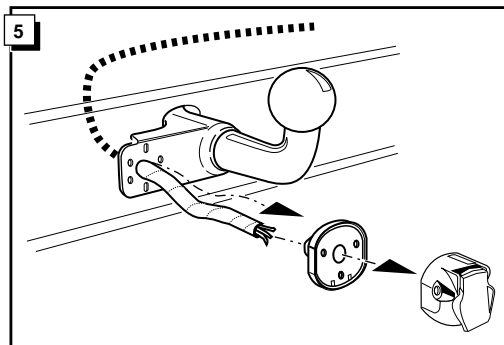
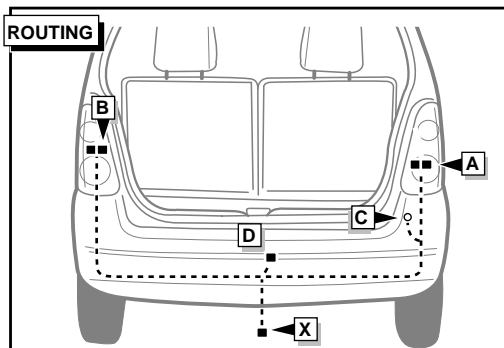

**6**

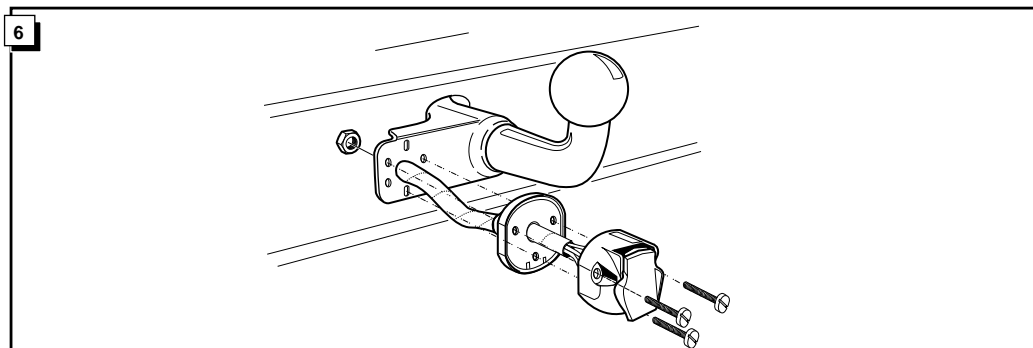

**7**

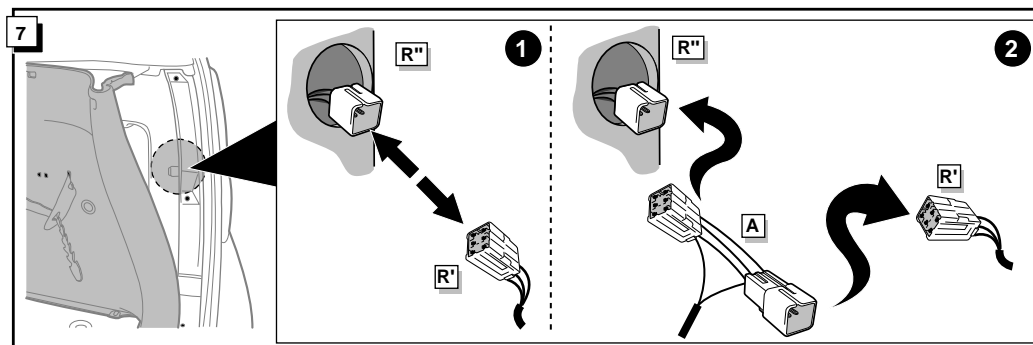

**INFO**

**Anschluß Steckdose / Connection de la prise / Socket connection / Contactdoos aansluiting**

DIN/ISO 1724		D	F	GB	NL
←	1/L	gelb	jaune	yellow	geel
↔	2	blau	bleu	blue	blauw
⏏ 1-8	3/31	weiß	blanc	white	wit
→	4/R	grün	vert	green	groen
☀	5/58-R	braun	marron	brown	bruin
STOP	6/54	rot	rouge	red	rood
☀	7/58-L	schwarz	noir	black	zwart
↔	8/58-b	grau	gris	grey	grijs

**8**

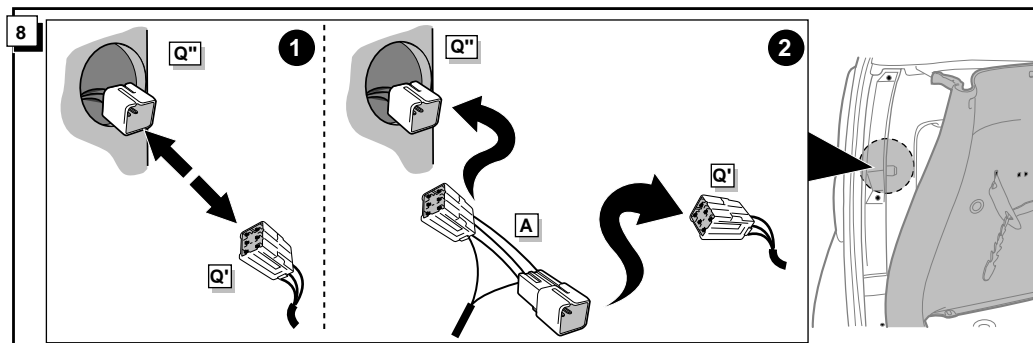

**9**

