

9

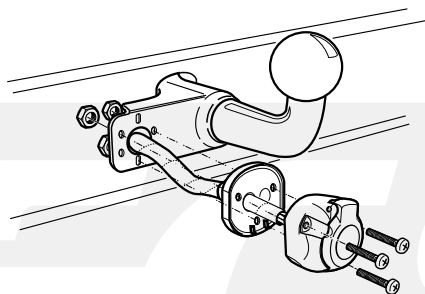

Anschluß Steckdose / Connection de la prise / Socket connection / Contactdoos aansluiting

INFO						
DIN/ISO 11446		D	F	GB	NL	Pmax
	1/L	gelb	jaune	yellow	geel	21W
	2	blau	bleu	blue	blauw	2x21W
	3/31	weiß	blanc	white	wit	
	4/R	grün	vert	green	groen	21W
	5/58-R	braun	marron	brown	bruin	52W
	6/54	rot	rouge	red	rood	3x21W
	7/58-L	schwarz	noir	black	zwart	52W
	8/58-bL	grau	gris	grey	grijs	2x21W

10

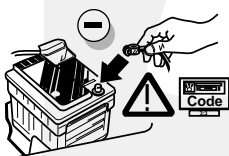

11

- D** FUNKTIONEN KONTROLLIEREN !  
**F** CONTRÔLER LES FONCTIONS !  
**GB** CHECK FUNCTIONS !  
**NL** CONTROLEER FUNCTIES !

12

- D** Teile zurückmontieren.  
**F** Montez les part enlevés.  
**GB** Reinstall linings.  
**NL** Onderdelen terug plaatsen.

## PEUGEOT 206 SW 2002- Nr.: PE-013-BB

\* Teilliste \* Liste de pieces \* Part list \* Onderdelenlijst

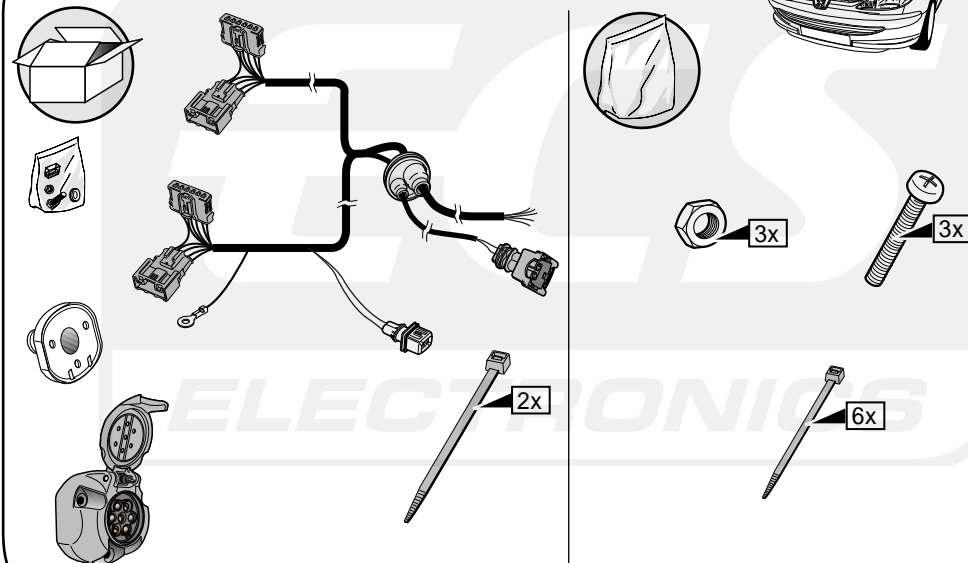

**D** Einbauanleitung Elektrosatz  
Anhängervorrichtung mit 12-N Steckdose  
lt. DIN/ISO Norm 1724

**GB** Fitting instructions electric wiringkit  
towbar with 12-N socket up to  
DIN/ISO norm 1724

**F** Instructions de montage du faisceau  
électrique pour crochet d'attelage  
conforme à la norme  
DIN/ISO 1724 prise 12-N

**NL** Montage-handleiding elektrokabelset  
voor trekhaak met 12-N contactdoos  
vlg. DIN/ISO norm 1724

**D**

- Wir weisen ausdrücklich darauf hin, das eine unsachgemäße und nicht in einer Fachwerkstätte durchgeführte Montage einen Verzicht auf die Geltendmachung jeglicher Art insbesondere auch aus dem Titel des Produkthaftpflichtrechtes bewirkt.
- Technische Änderungen vorbehalten.
- Belastung nur tabellgemäß auf dem anhänger verwenden, sehe Seite 4.

**F**

- Il est expressement prévu qu' on ne saurait se prévaloir d'un quelconque préjudice contractuel ou réditatoire si le montage avait été fait en dépit des dites instructions ou dans un garage ne disposant pas des équipements adéquats.
- Sous réserve de modifications techniques.
- Ne excédez pas la charge maximale, indiquée dans le tableau sur page 4.

**GB**

- We would expressly point out that any improper assembly which is not carried out in a specialist workshop will result in the renunciation of the enforcement of compensation claims of any kind, in particular those arising by virtue of the product liability law.
- Subject to alteration without notice.
- Only use maximum charge according to connectiontable on towed vehicle, see page 4.

**NL**

- Wij wijzen er met nadruk op, dat ondeskundige en niet door een vakkundige werkplaats uitgevoerde montage tot gevolg heeft dat daardoor ieder recht op schadevergoeding, ook op wettelijke aansprakelijkheid inzake producten, vervalt.
- Technische wijzigingen voorbehouden.
- Gebruik alleen belasting volgens aansluittabel op het getrokken voertuig, zie pagina 4.

1

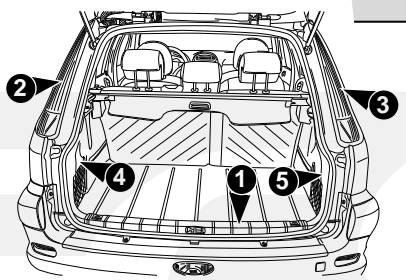
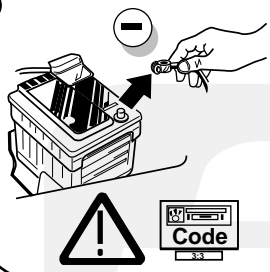

D

Abmontieren Teile

1

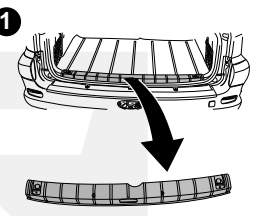

F

Démontez les parts

2

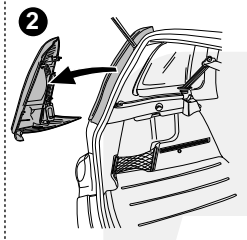

GB

Remove linings

3

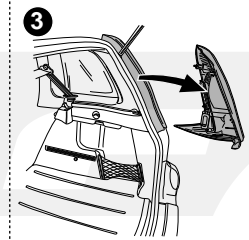

NL

Verwijder onderdelen

4

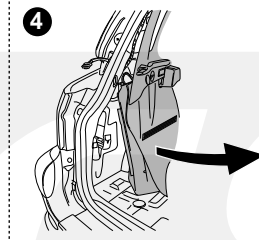

5

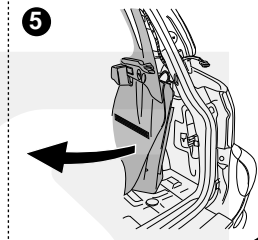

INFO

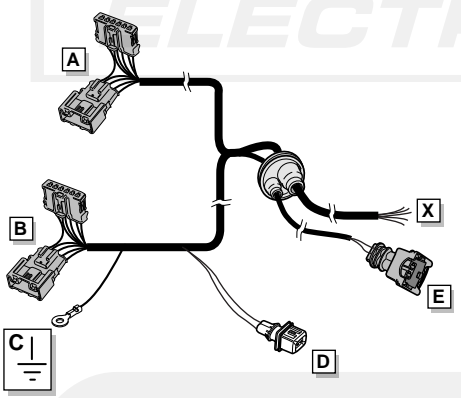

ROUTING

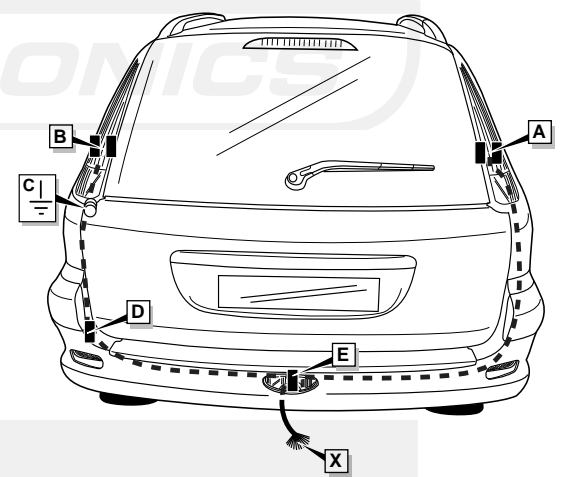

2

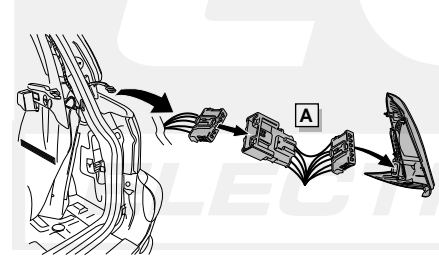

3

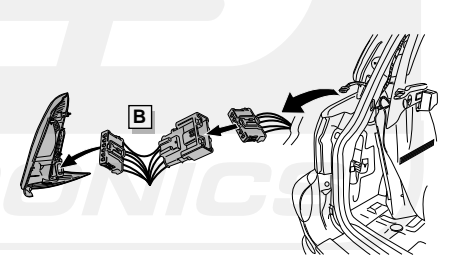

4

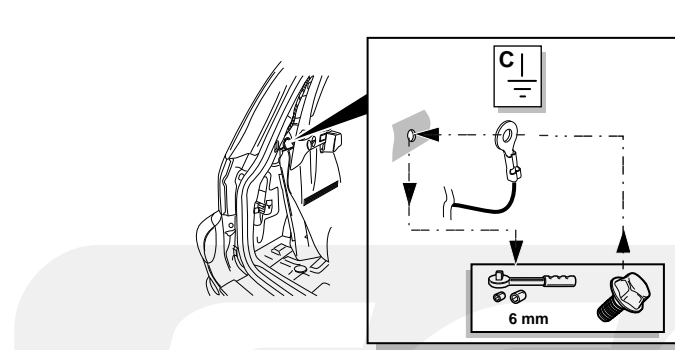

5

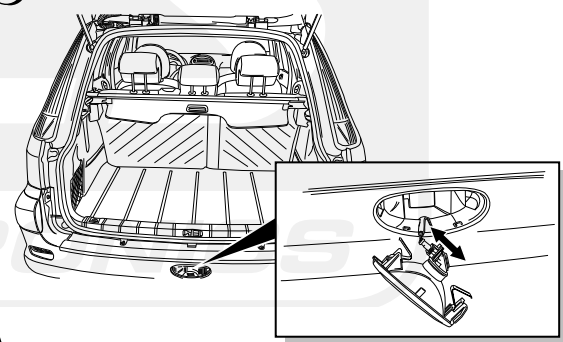

6

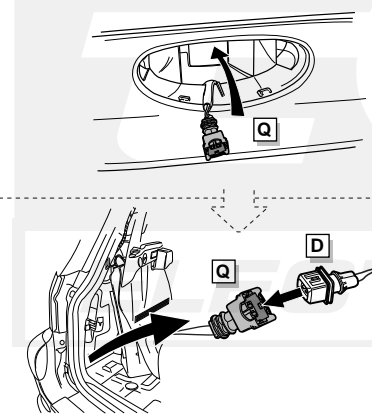

7

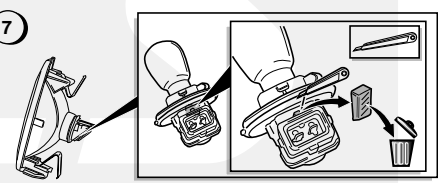

8

