

**Einbauanleitung Elektrosatz
Anhängervorrichtung mit 12-N Steckdose
lt. DIN/ISO Norm 1724**

**Instructions de montage du faisceau
électrique pour crochet d'attelage
conforme à la norme
DIN/ISO 1724 prise 12-N**

**Fitting instructions electric wiringkit
towbar with 12-N socket up to
DIN/ISO norm 1724**

**Montage-handleiding elektrokabelset voor
trekhaak met 12-N contactdoos
vlg. DIN/ISO norm 1724**

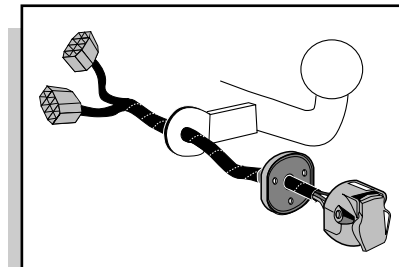

TOYOTA PICNIC 1996-

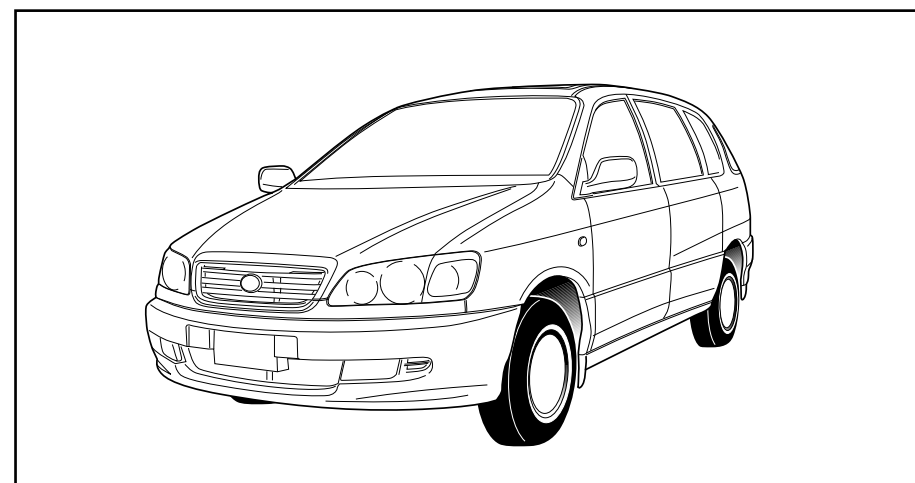

Bestel Nr.: TOY-083-L

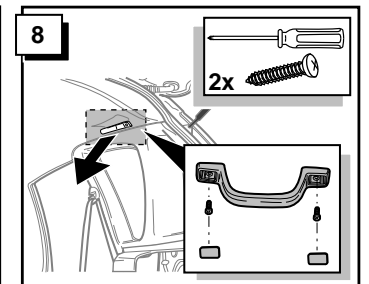
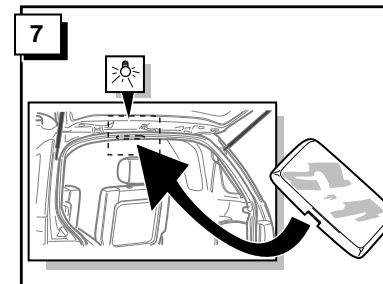
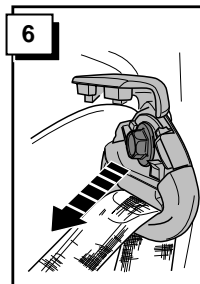
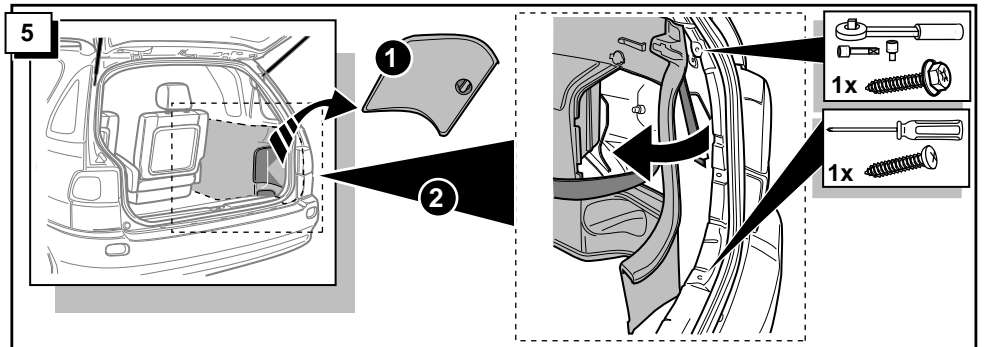
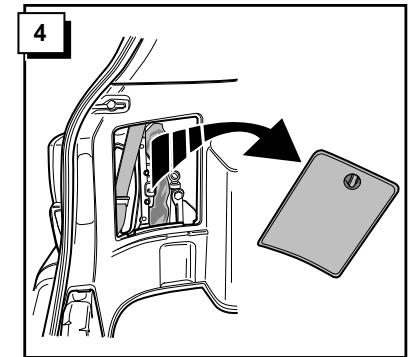
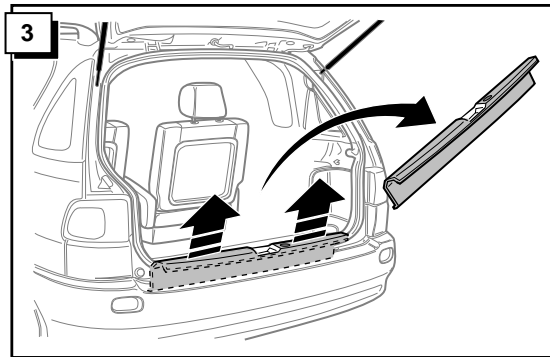
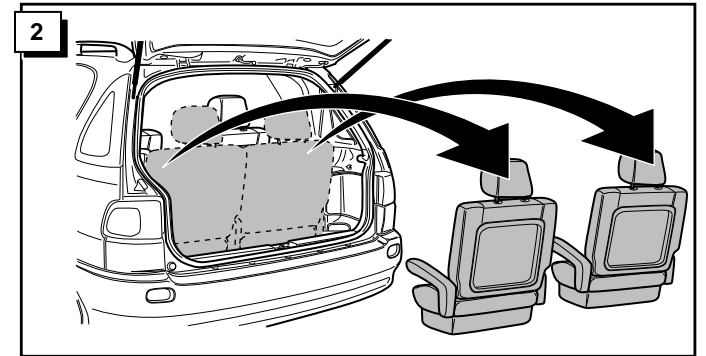
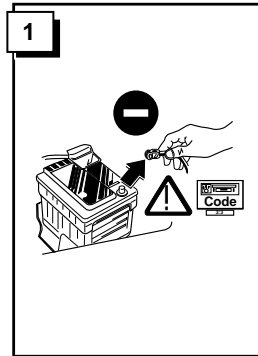

Info

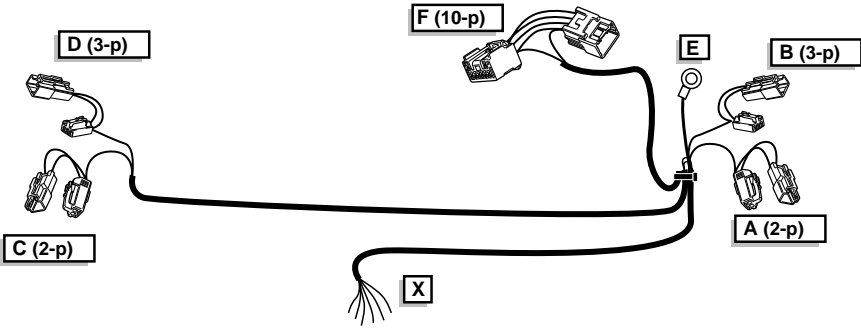

ROUTING

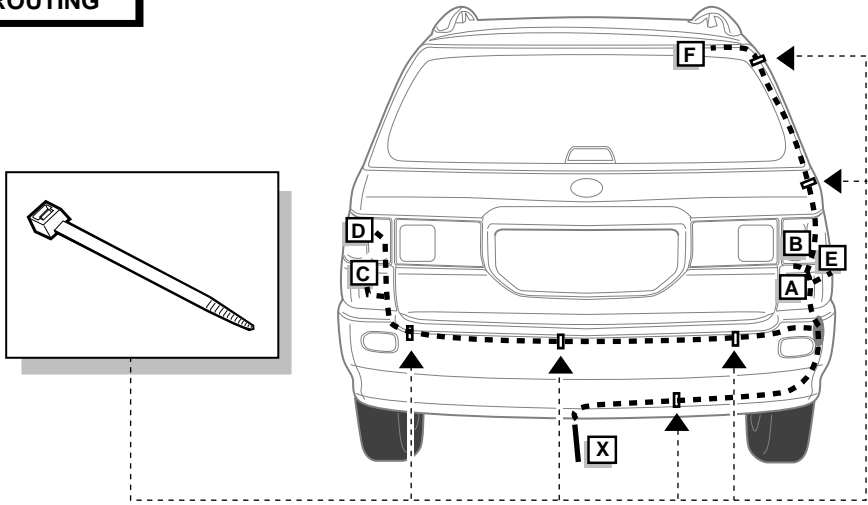

9

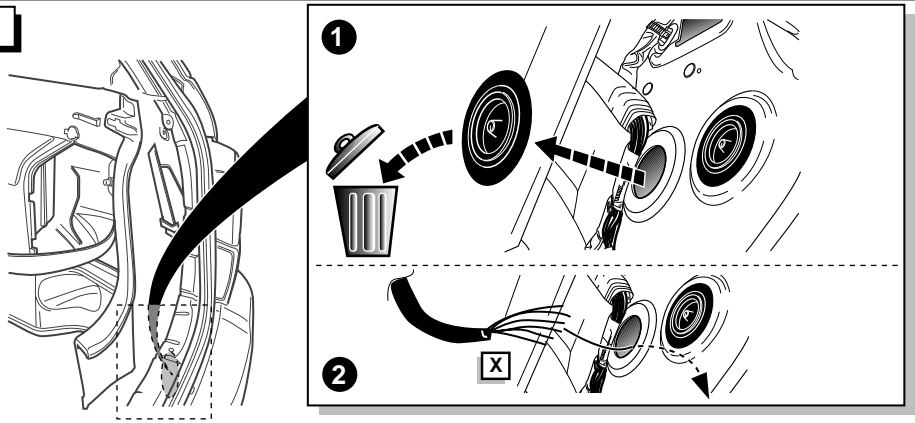

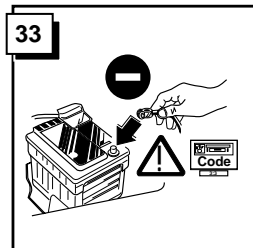
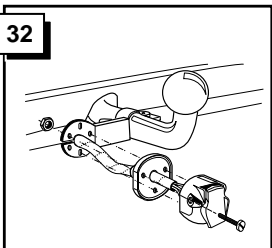
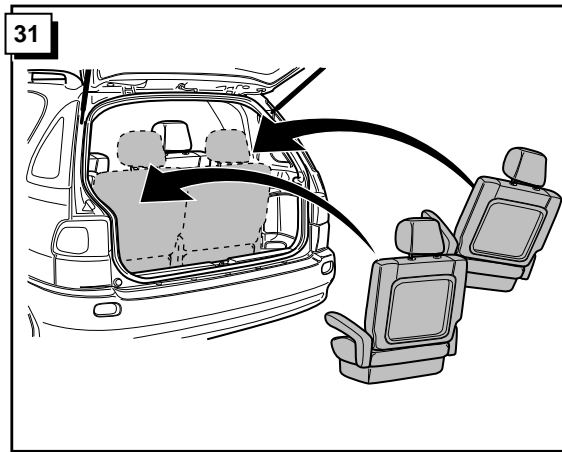
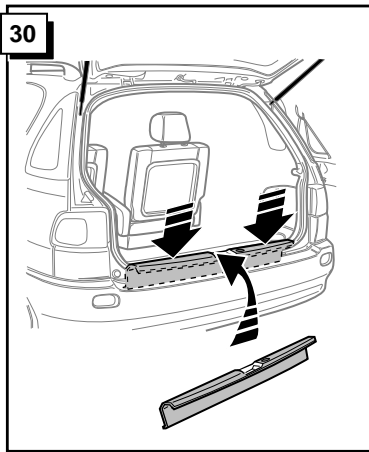
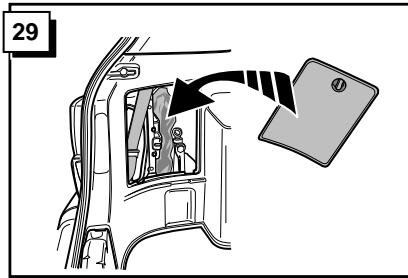
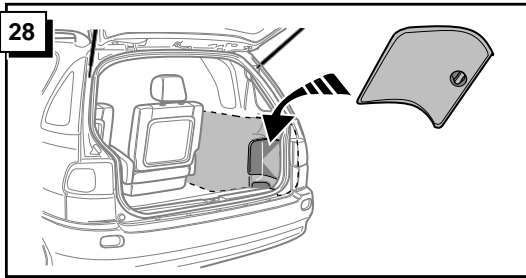
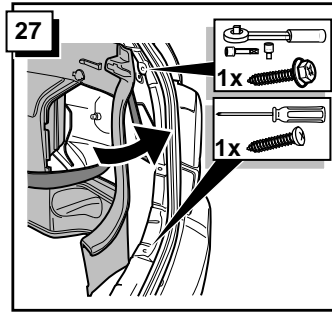
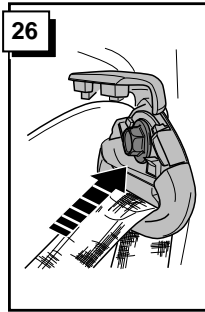
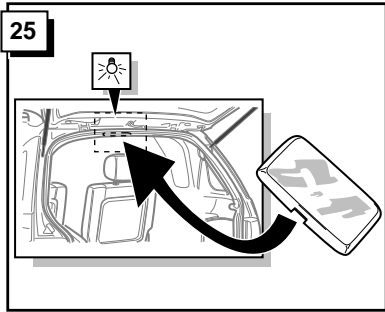

34

! CONTROLEER FUNCTIES !
! CHECK FUNCTIONS !
! FUNKTIONEN KONTROLIEREN !
! CONTRÔLER LES FONCTIONS !

