

Montage-handleiding elektrokabelset voor
trekhaak met 12-N contactdoos
vlg. DIN/ISO norm 1724

Fitting instructions electric wiringkit
towbar with 12-N socket up to
DIN/ISO norm 1724

Einbauanleitung Elektrosatz
Anhängervorrichtung mit 12-N Steckdose
lt. DIN/ISO Norm 1724

Instructions de montage du faisceau
électrique pour crochet d'attelage
conforme à la norme DIN/ISO 1724
prise 12-N

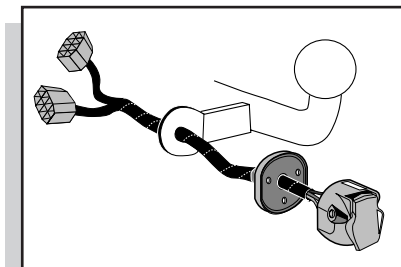

TOYOTA AVENSIS SEDAN 1998-07/2000

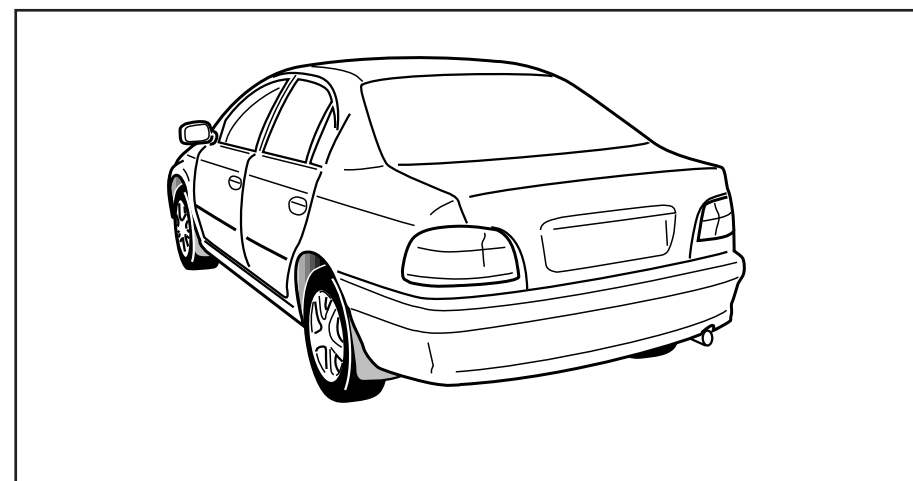

Bestel Nr.: TO-001-BL

* Teilliste

* Liste de pieces

* Part list

* Onderdelenlijst

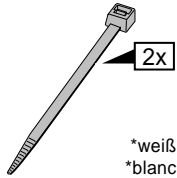
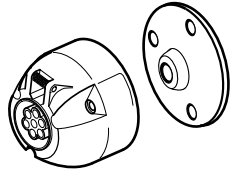
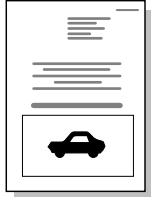
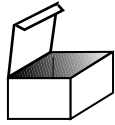

*weiß
*blanc
*white
*wit

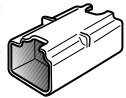

*grau
*gris
*grey
*grijs

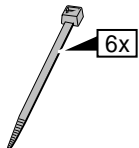
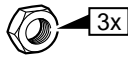
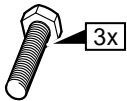
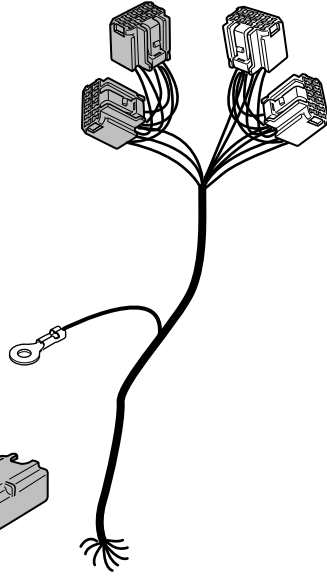
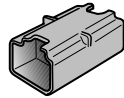

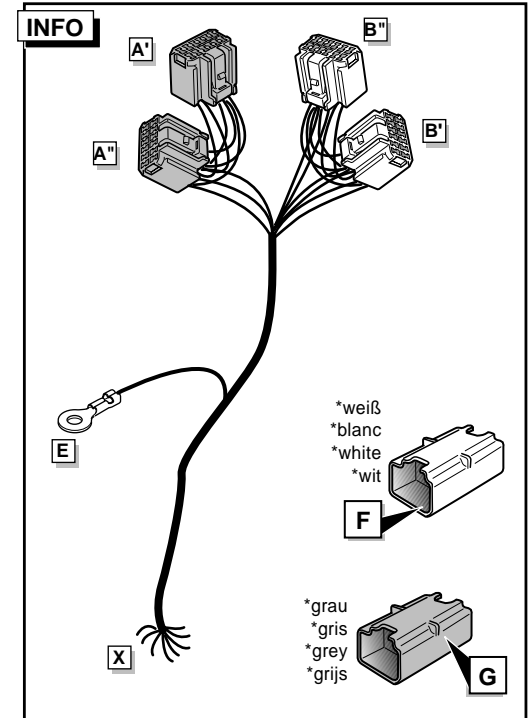
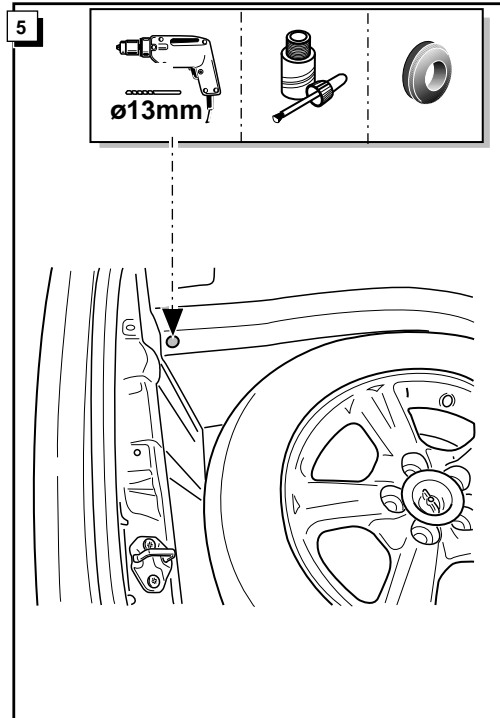
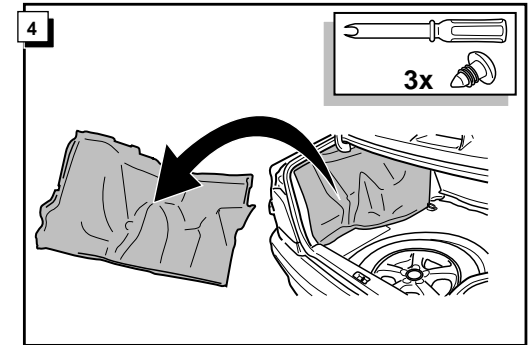
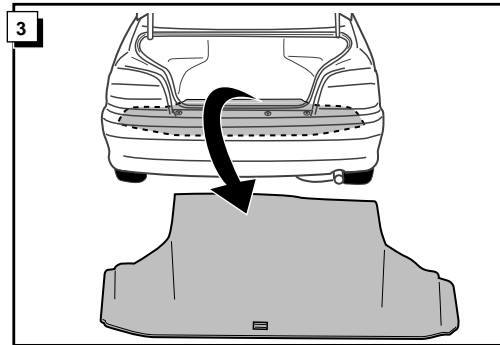
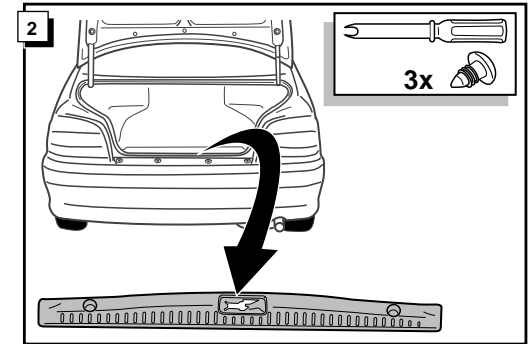
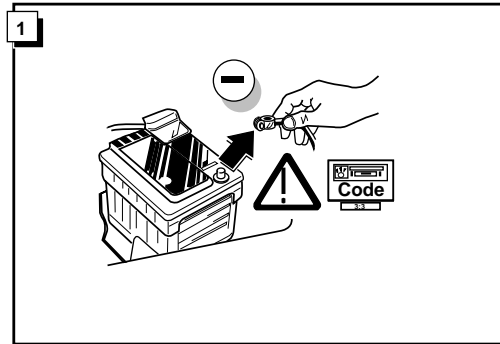

INFO Anschluß Steckdose / Connection de la prise / Socket connection / Contactdoos aansluiting

DIN/ISO 1724		D	F	GB	NL
	1/L	gelb	jaune	yellow	geel
	2	blau	bleu	blue	blauw
	3/31	weiß	blanc	white	wit
	4/R	grün	vert	green	groen
	5/58-R	braun	marron	brown	bruin
	6/54	rot	rouge	red	rood
	7/58-L	schwarz	noir	black	zwart
	8/58-b	grau	gris	grey	grijs

6

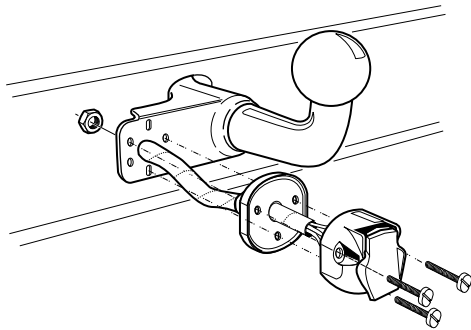

7

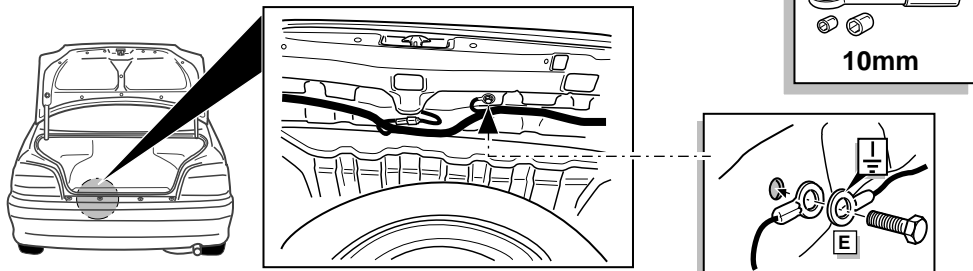

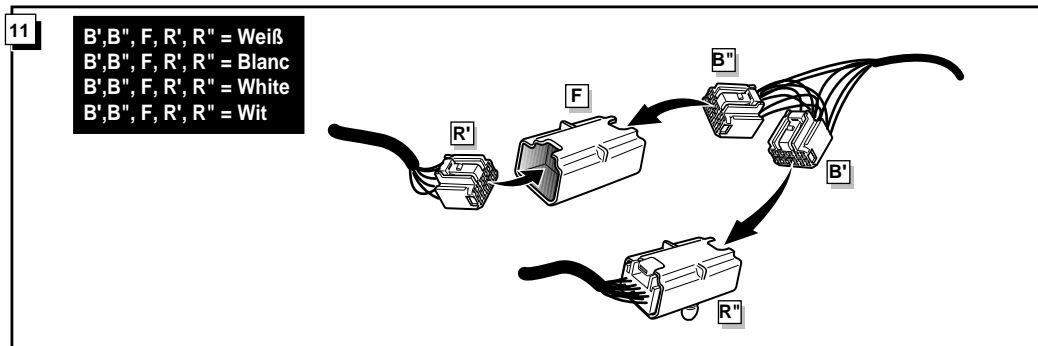
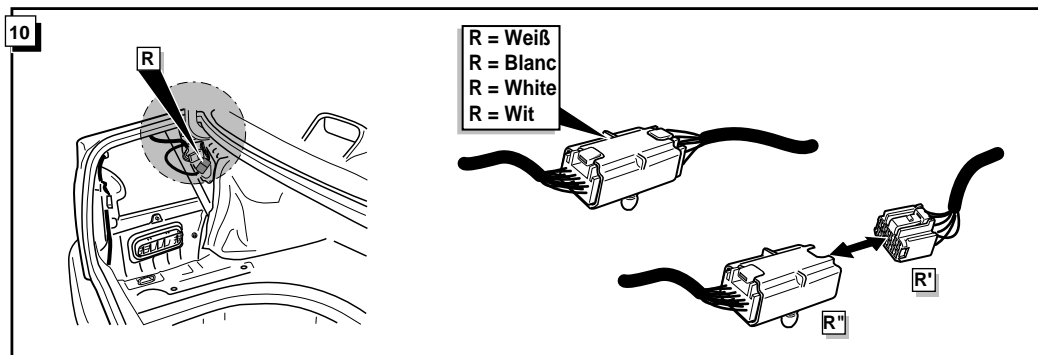
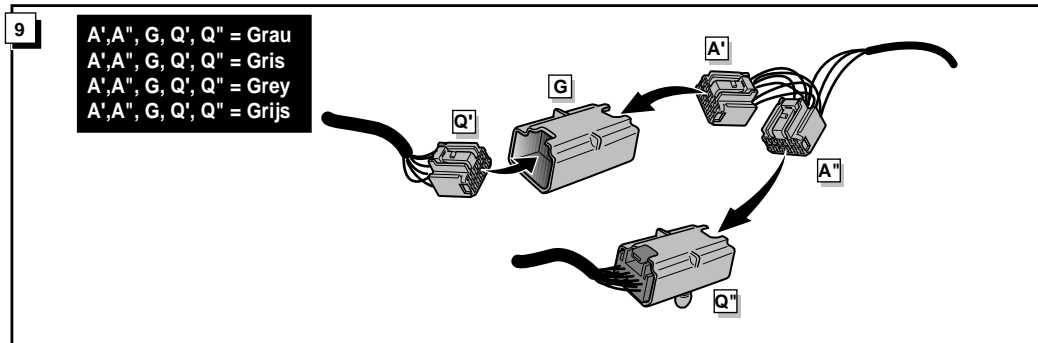
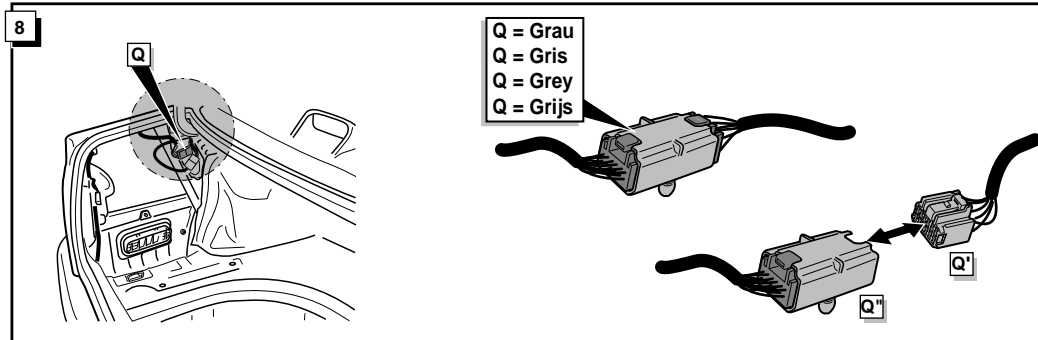
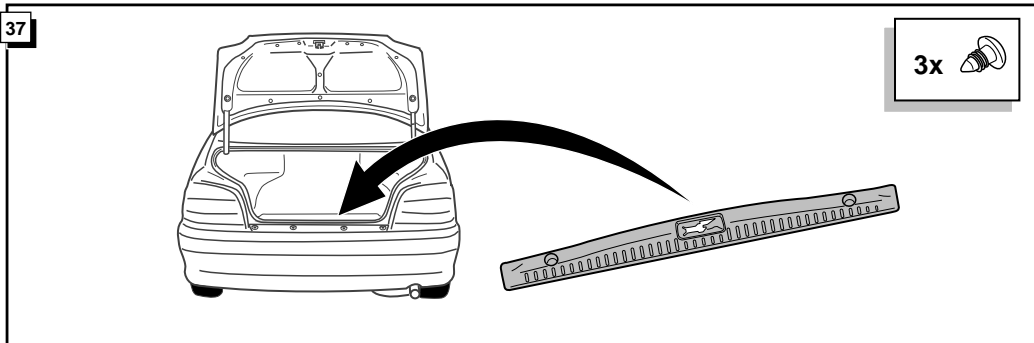
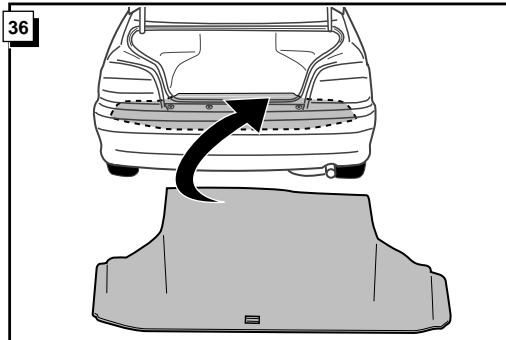
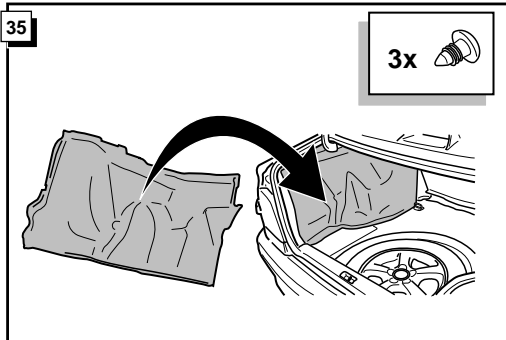

12

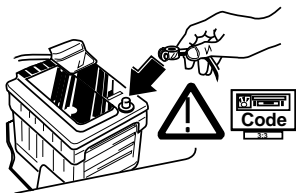

13

! FUNKTIONEN KONTROLIEREN !
! CONTRÔLER LES FONCTIONS !
! CHECK FUNCTIONS !
! CONTROLEER FUNCTIES !

31

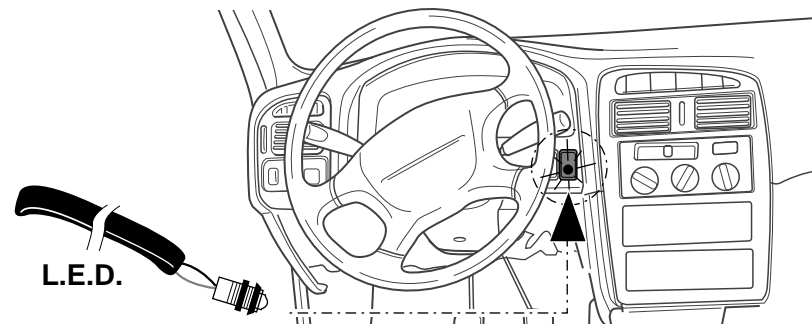

INFO

- ** Wenn die Anhängerleuchten nicht funktionieren siehe fig. 14 bis 37, wenn sie funktionieren siehe fig 23 bis 37.
- ** Quand les feux de la remorque ne fonctionnent pas voir fig 14 jusqu'à 37, quand ils fonctionnent voir fig 23 jusqu'à 37.
- ** If the trailerlights do not function see fig. 14 up to 37, if they function properly see fig.23 up to 37.
- ** Als de aanhangerverlichting niet functioneert zie fig. 14 t/m fig. 37, als de aanhangerverlichting wel functioneert zie fig 23 t/m 37.

32

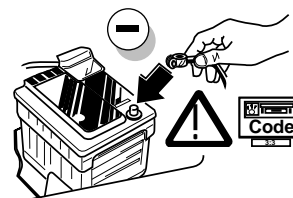

33

! FUNKTIONEN KONTROLIEREN !
! CONTRÔLER LES FONCTIONS !
! CHECK FUNCTIONS !
! CONTROLEER FUNCTIES !

14

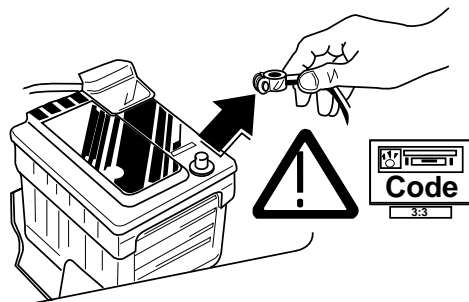

INFO

Die Kontrolleuchte blinkt, wenn beim angeschlossenen Anhänger die Blinker (3x21W) oder Warnblinkanlage (6x21W) eingeschaltet sind.

Le deuxième témoin de contrôle clignote lorsque les feux de détresses (6X21W) et les clignotants (3X21W) du véhicule sont allumés alors que la caravane/remorque est accouplée au véhicule.

By switching on flashers with the trailer connected (3x21W) or the warning lights (6x21W), the 2nd direction indicator light will flash.

Het controle-lampje knippert wanneer bij aangesloten aanhanger de knipperlichten (3x21W) of waarschuwingslichten (6x21W) ingeschakeld zijn.

15

A',A", G, Q', Q" = Grau
 A',A", G, Q', Q" = Gris
 A',A", G, Q', Q" = Grey
 A',A", G, Q', Q" = Grijs

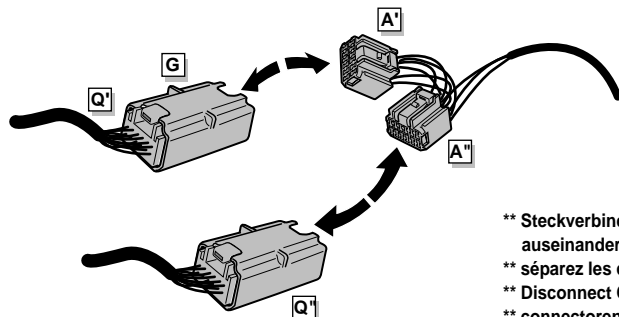

** Steckverbinder auseinandernehmen.
 ** séparez les connecteurs.
 ** Disconnect Connectors.
 ** connectoren los maken.

34

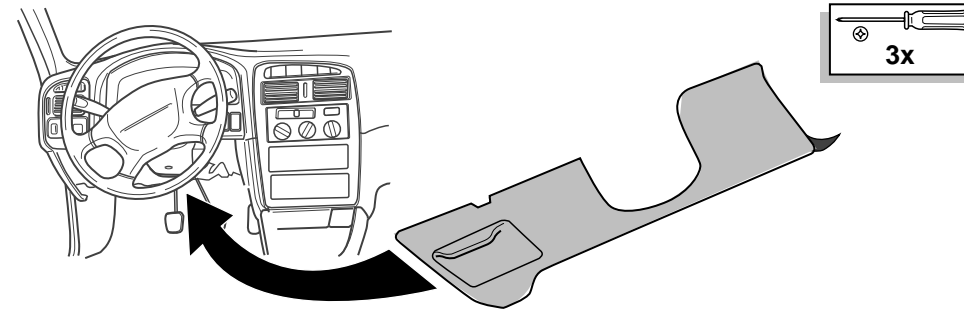

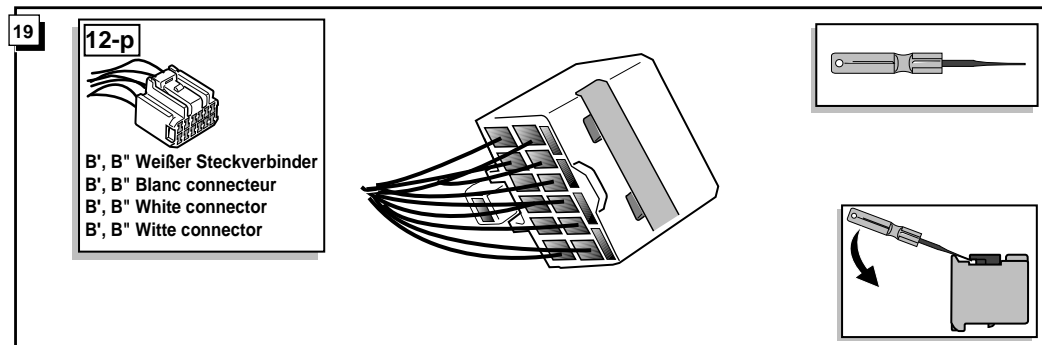
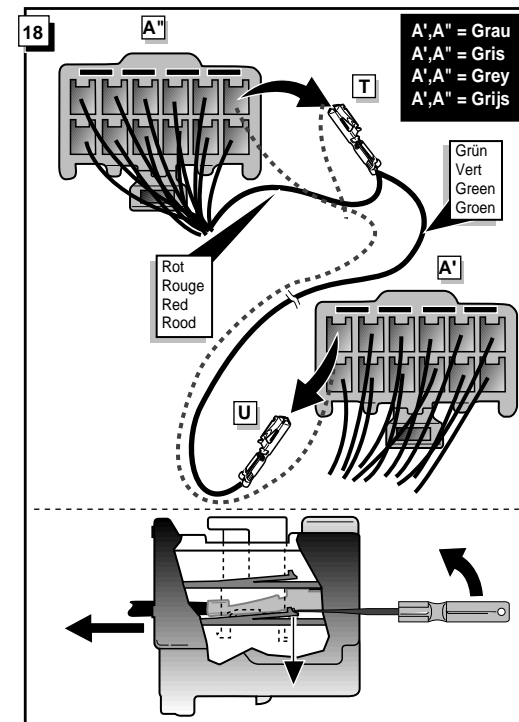
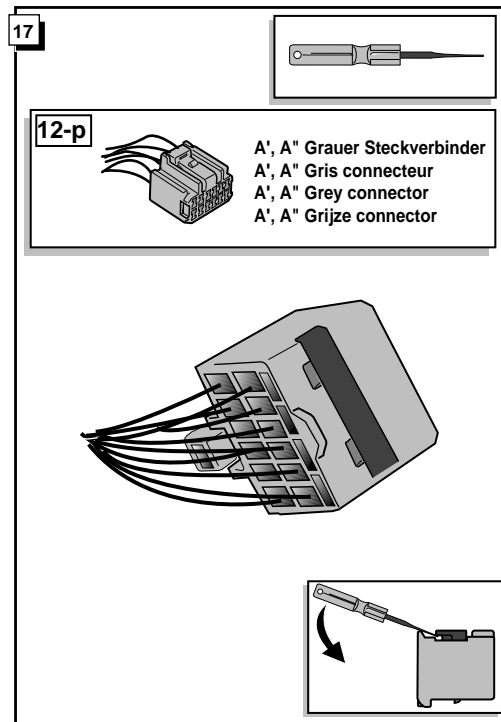
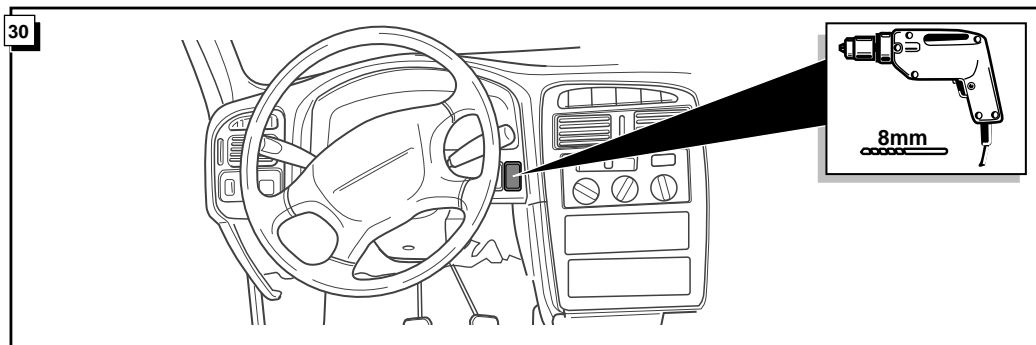
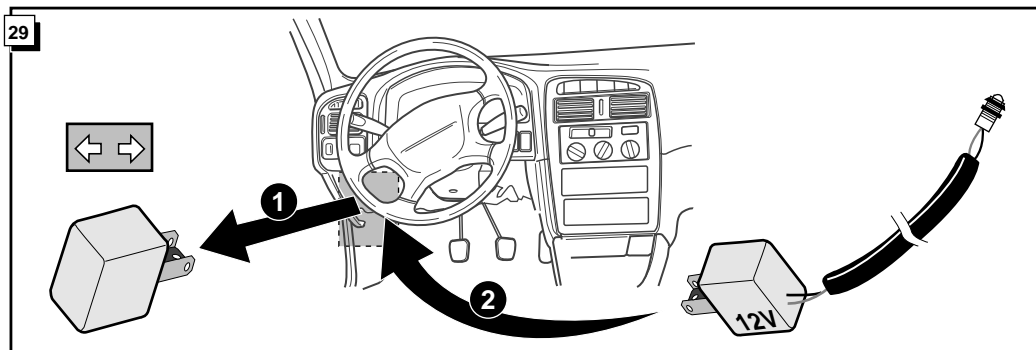
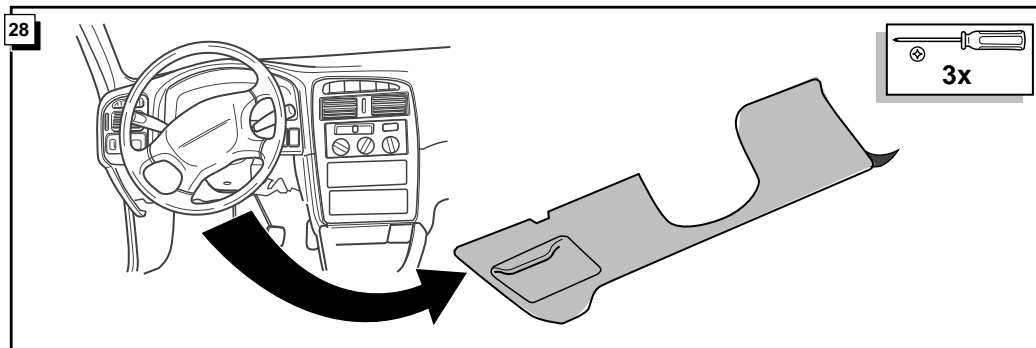
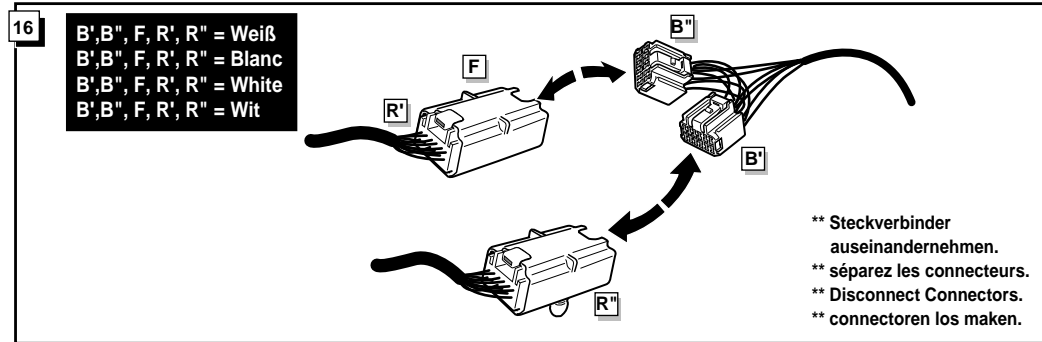
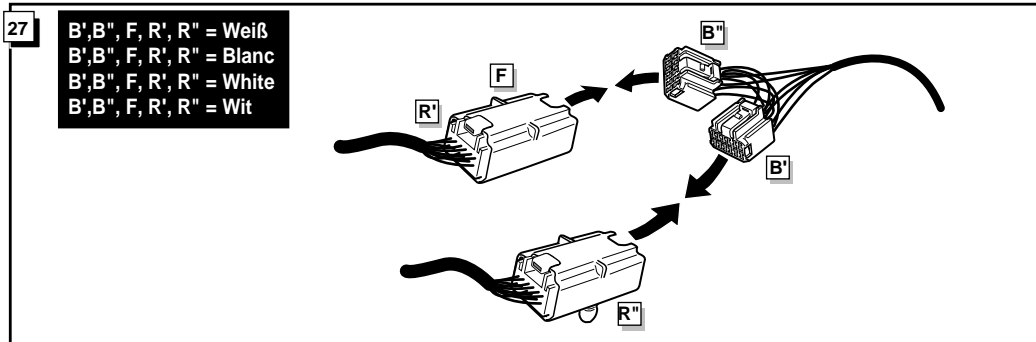

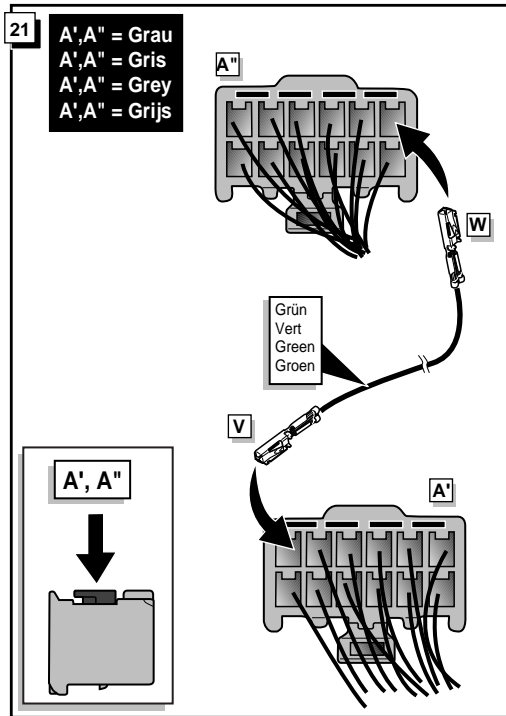
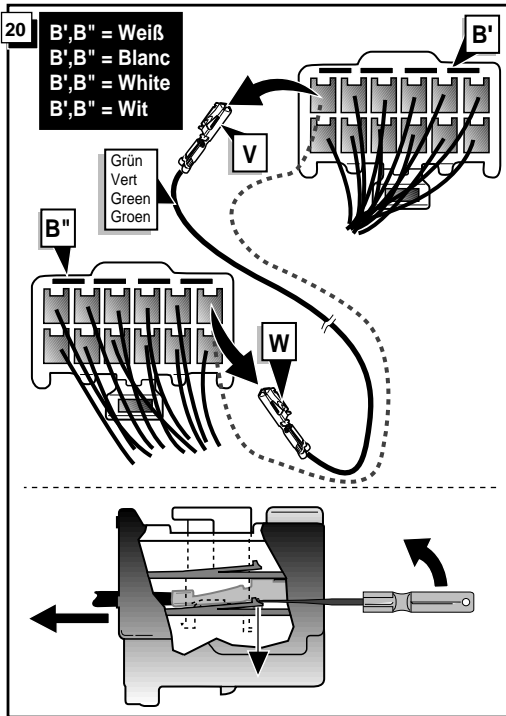

24 Anschluß Steckdose / Connection de la prise / Socket connection / Contactdoos aansluiting

DIN/ISO 1724		D	F	GB	NL
←	1/L	gelb	jaune	yellow	geel
↺	2	blau	bleu	blue	blauw
⊥	1-8	weiß	blanc	white	wit
→	4/R	grün	vert	green	groen
☀	5/58-R	braun	marron	brown	bruin
STOP	6/54	rot	rouge	red	rood
☀	7/58-L	schwarz	noir	black	zwart
⊕ → ⊖	8/58-b	grau	gris	grey	grijs

