

Einbauanleitung Elektrosatz
Anhängervorrichtung mit 12-N Steckdose
lt. DIN/ISO Norm 1724

Instructions de montage du faisceau
électrique pour crochet d'attelage
conforme à la norme
DIN/ISO 1724 prise 12-N

Fitting instructions electric wiringkit
towbar with 12-N socket up to
DIN/ISO norm 1724

Montage-handleiding elektrokabelset voor
trekhaak met 12-N contactdoos
vlg. DIN/ISO norm 1724

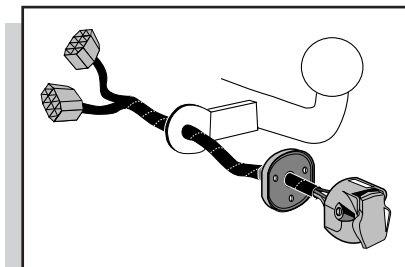

NISSAN ALMERA TINO 2000-

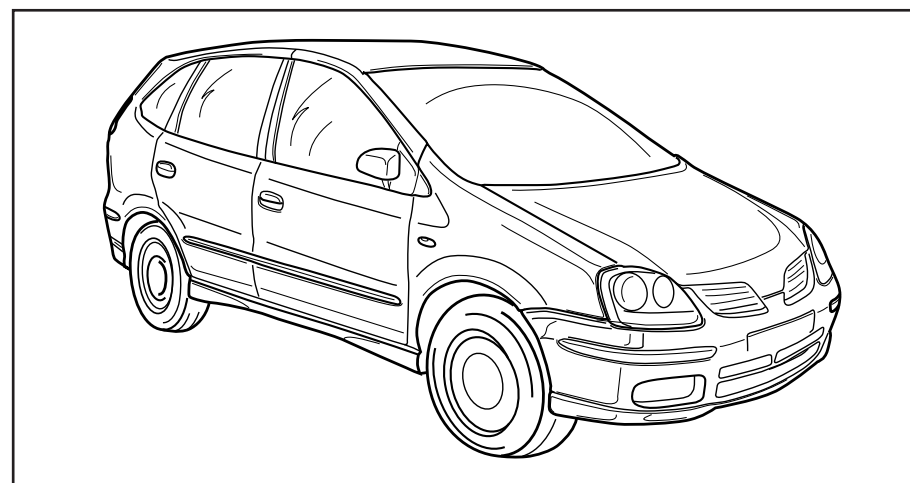

Bestel Nr.: NI-015-BL

* Teilliste

* Liste de pieces

* Part list

* Onderdelenlijst

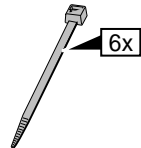
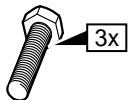
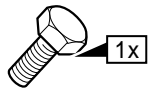
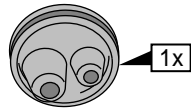
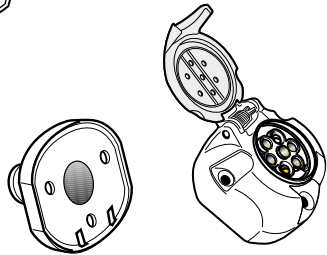
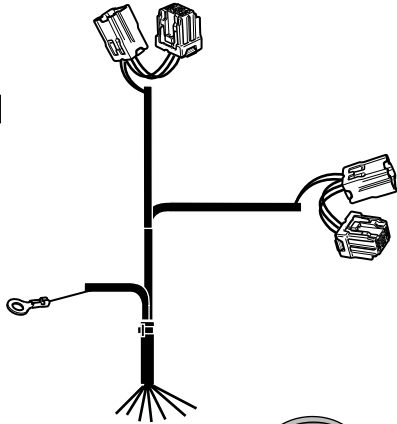
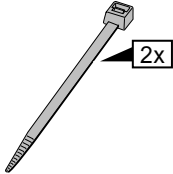
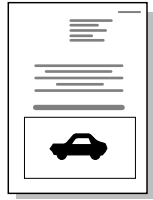
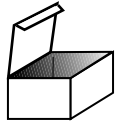

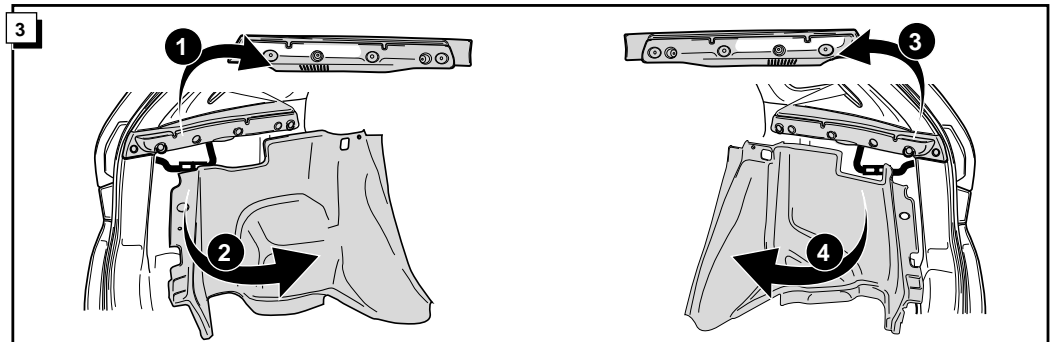
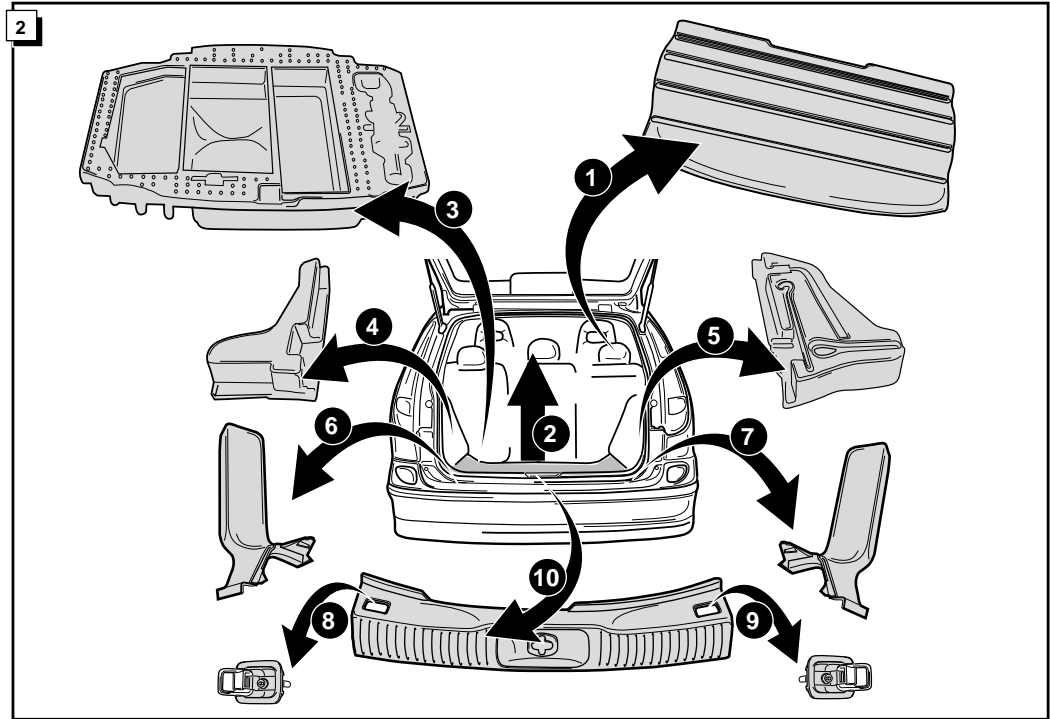
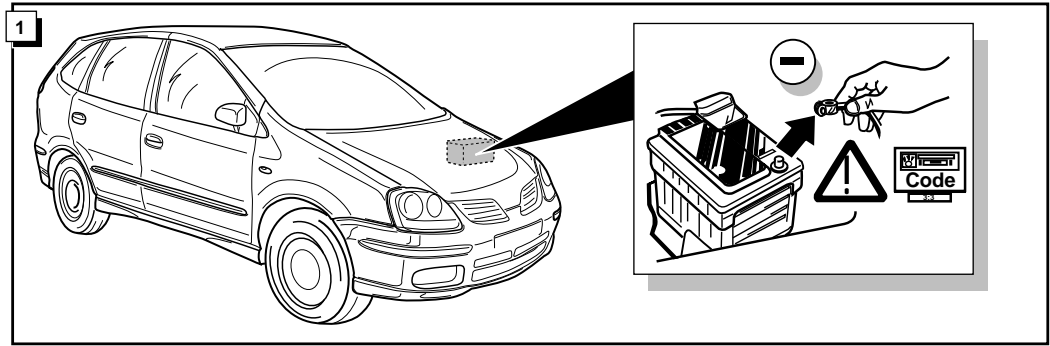

INFO

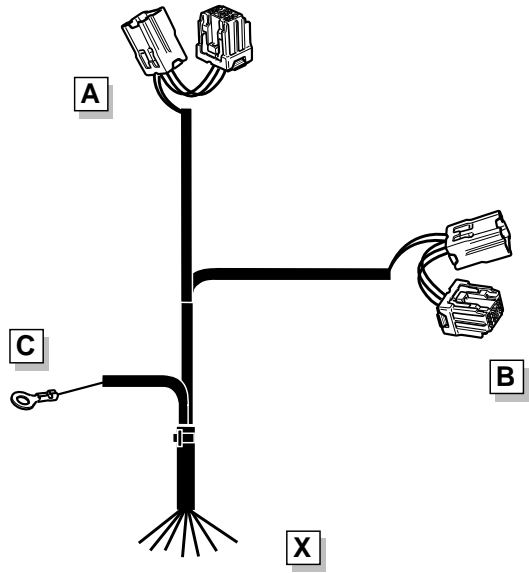

ROUTING

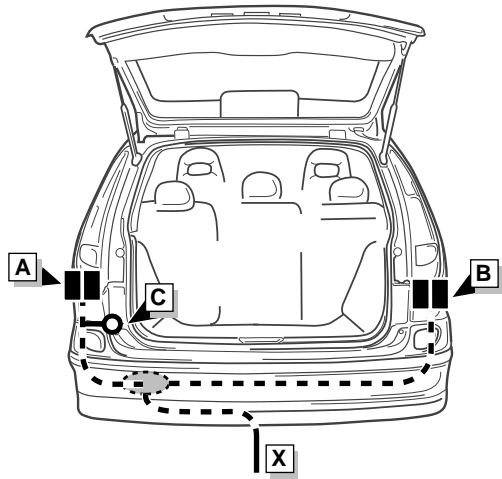

12

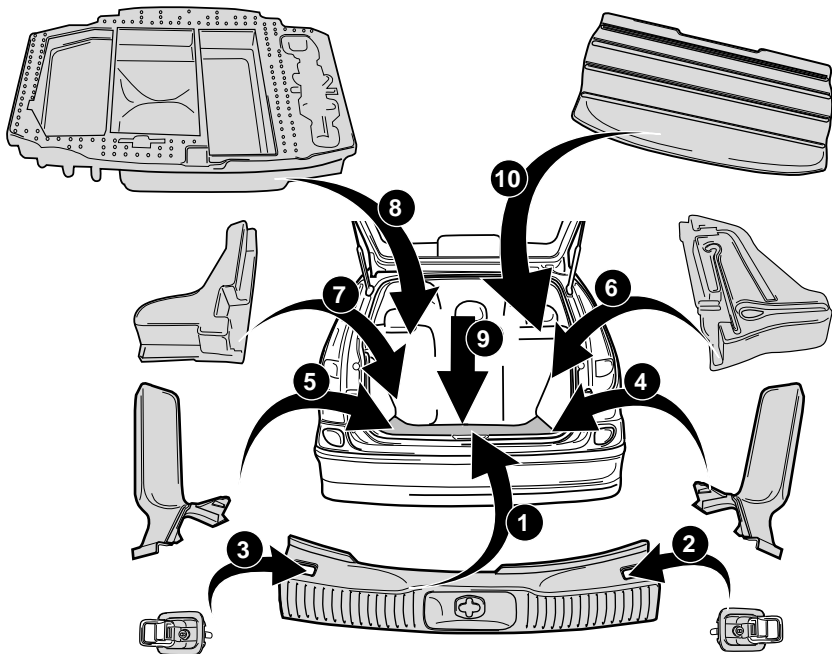

4

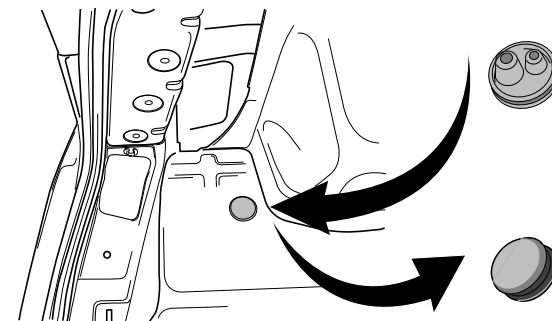

5

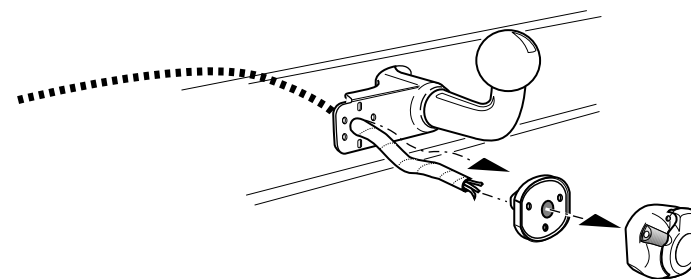

INFO Anschluß Steckdose / Connection de la prise / Socket connection / Contactdoos aansluiting

DIN/ISO 1724		D	F	GB	NL
	1/L	gelb	jaune	yellow	geel
	2	blau	bleu	blue	blauw
	3/31	weiß	blanc	white	wit
	4/R	grün	vert	green	groen
	5/58-R	braun	marron	brown	bruin
	6/54	rot	rouge	red	rood
	7/58-L	schwarz	noir	black	zwart
	8/58-b	grau	gris	grey	grijs

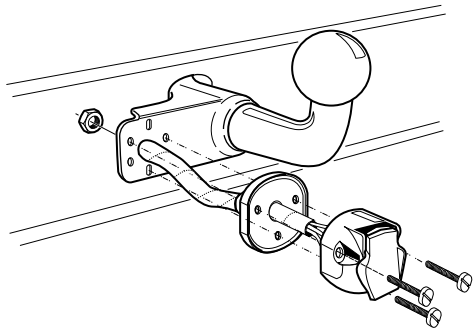
6

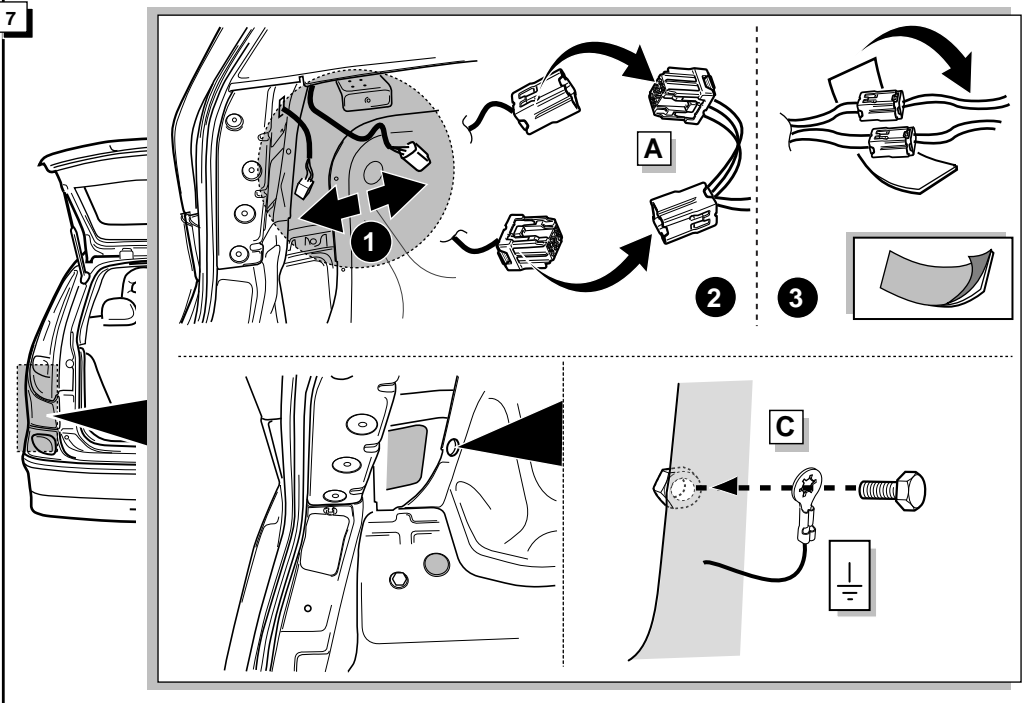

7



8

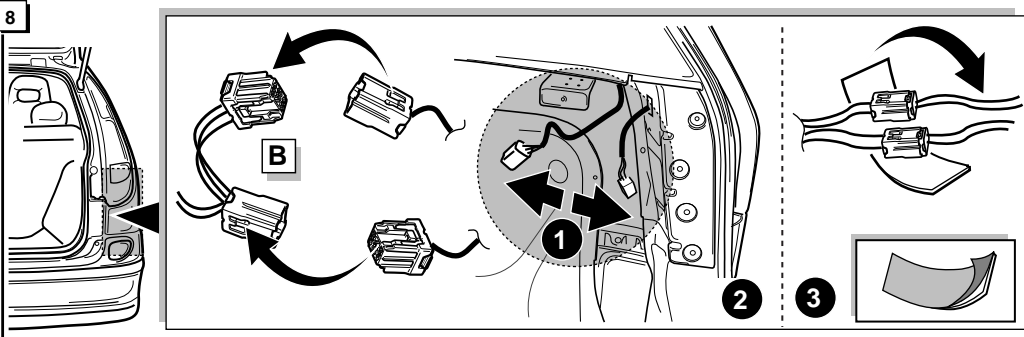

INFO

- * Die korrekte Wirkung der Anhängerblinker wird mittels eines Pfeiftones bestätigt.
- * Le fonctionnement correct des dignotants de la remorque est confirmé par un ton pépant.
- * The correct functioning of the trailer direction indicator lights is confirmed by a beeping tone.
- * De correcte werking van de aanhangerknipperlichten wordt d.m.v. een piepton bevestigd.

9

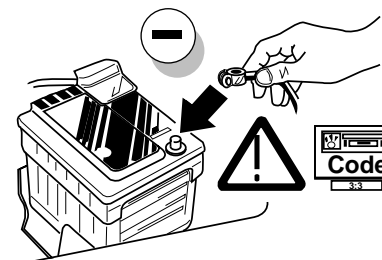

10

! FUNKTIONEN KONTROLLIEREN !
! CONTRÔLER LES FONCTIONS !
! CHECK FUNCTIONS !
! CONTROLEER FUNCTIES !

11

