

Montage-handleiding elektrokabelset voor
trekhaak met 13-P contactdoos
vlgs. DIN/ISO norm 11446

Fitting instructions electric wiringkit
towbar with 13-P socket up to
DIN/ISO norm 11446

Einbauanleitung Elektrosatz
Anhängervorrichtung mit 13-P Steckdose
lt. DIN/ISO Norm 11446

Instructions de montage du faisceau
électrique pour crochet d'attelage
conforme à la norme DIN/ISO 11446
prise 13-P

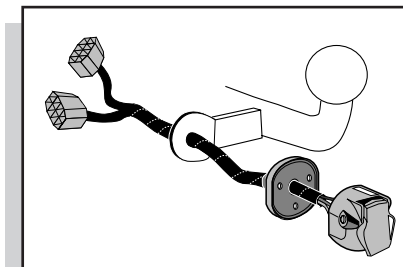

NISSAN PRIMERA ESTATE P11 1998-

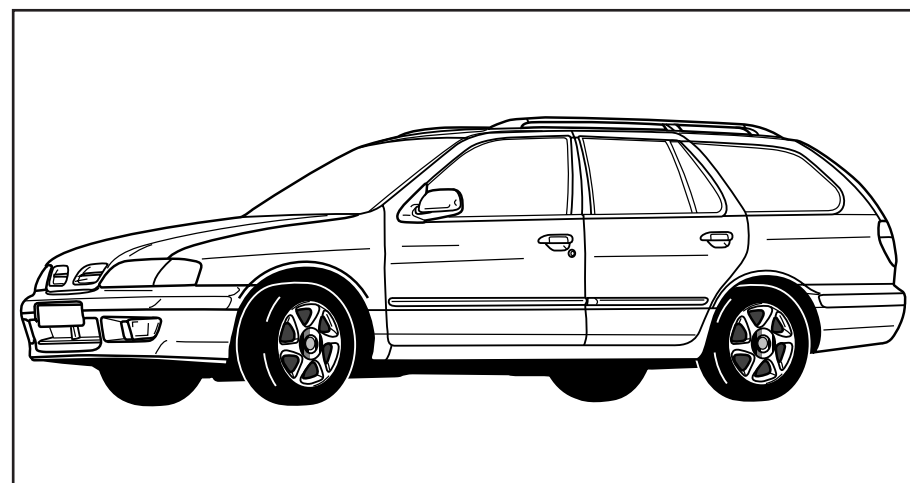

Bestel Nr.: NI-004-BL

* Teilliste

* Liste de pieces

* Part list

* Onderdelenlijst

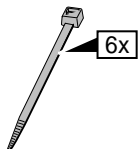
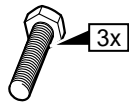
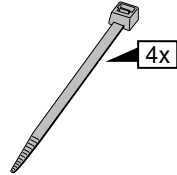
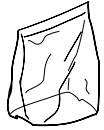
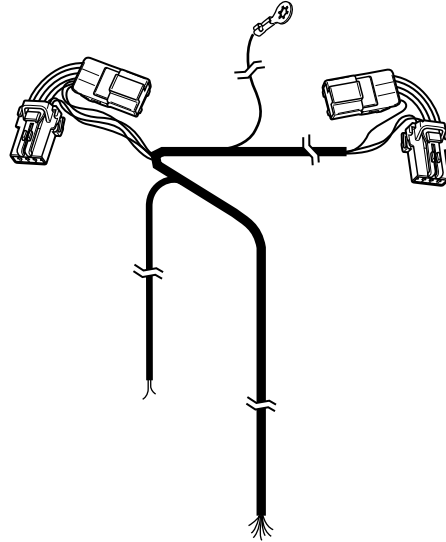
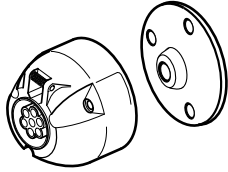
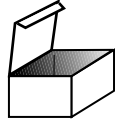

INFO

Die Kontrolleuchte blinkt, wenn beim angeschlossenen Anhänger die Blinker (3x21W) oder Warnblinkanlage (6x21W) eingeschaltet sind.

Le deuxième témoin de contrôle clignote lorsque les feux de détresses (6X21W) et les clignotants (3X21W) du véhicule sont allumés alors que la caravane/remorque est accouplée au véhicule.

By switching on flashers with the trailer connected (3x21W) or the warning lights (6x21W), the 2nd direction indicator light will flash.

Het controle-lampje knippert wanneer bij aangesloten aanhanger de knipperlichten (3x21W) of waarschuwingslichten (6x21W) ingeschakeld zijn.

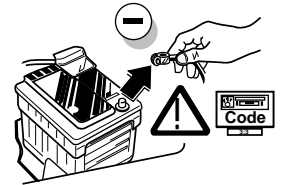
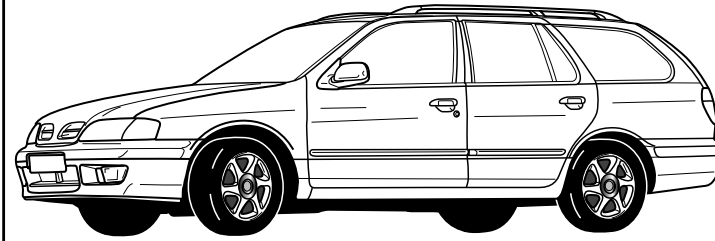
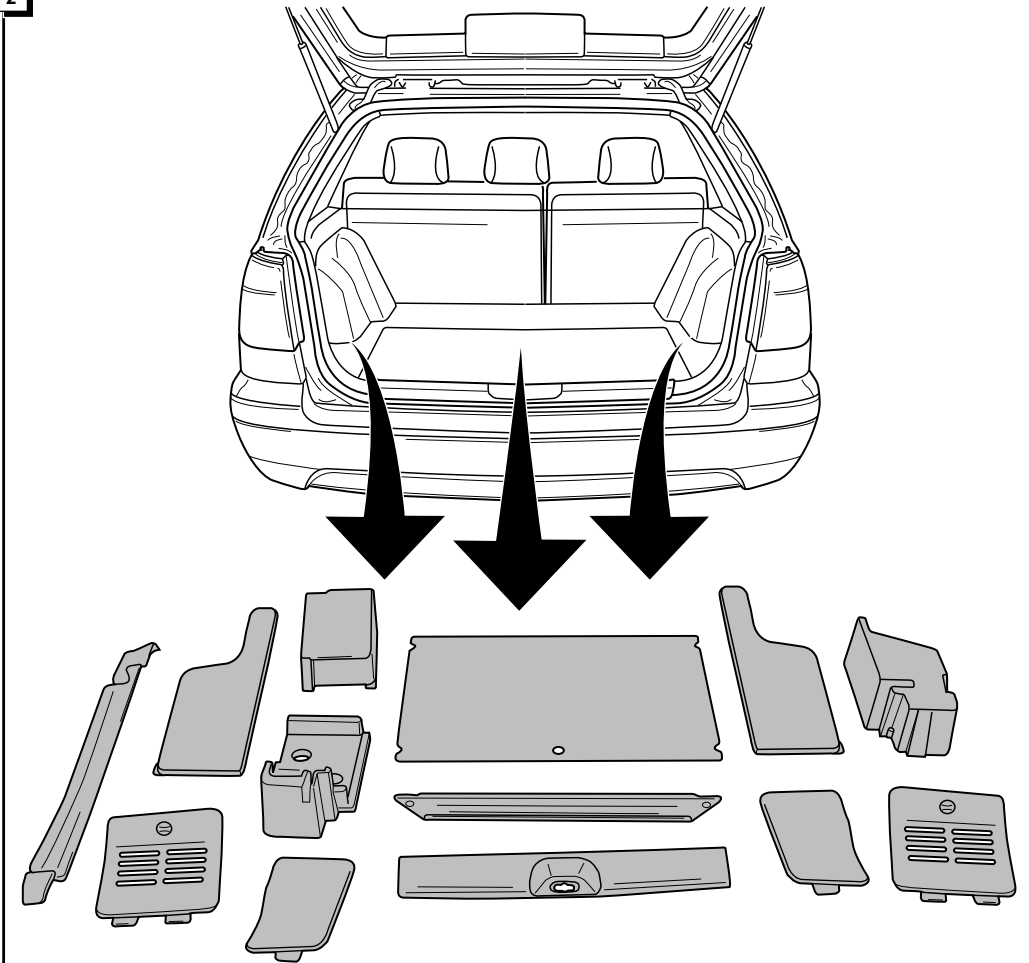
1**2**

3

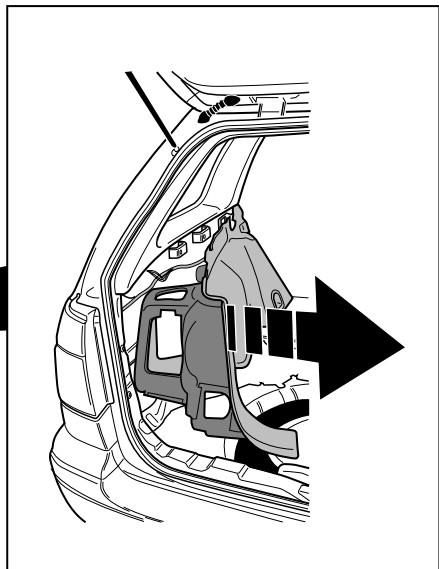
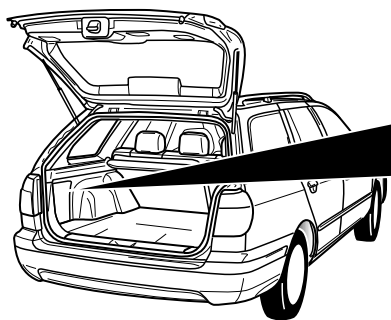

17

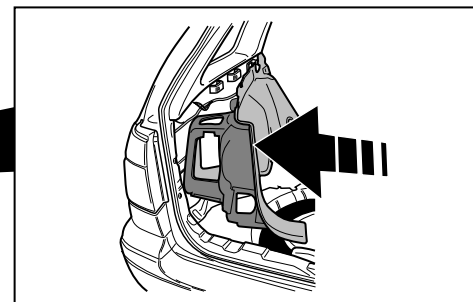
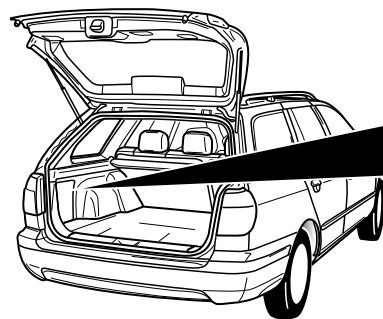

INFO

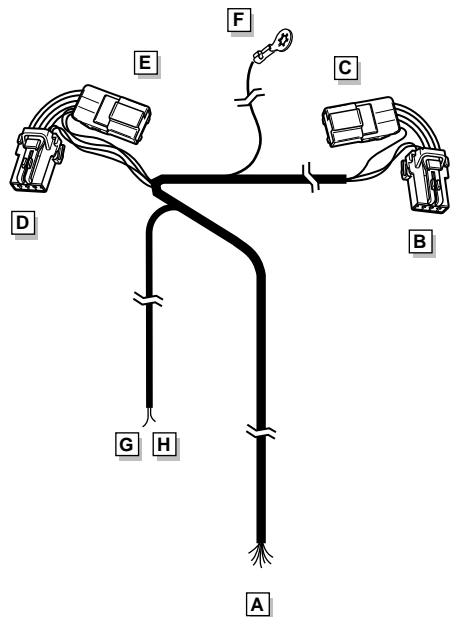

4

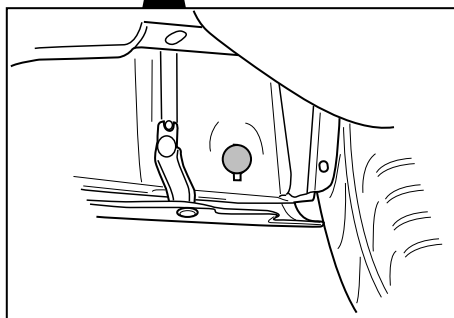
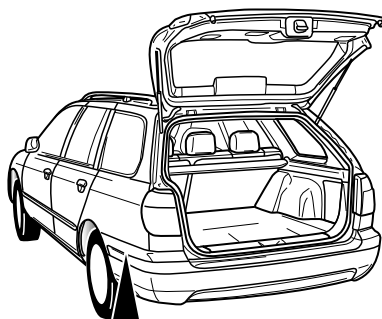

18

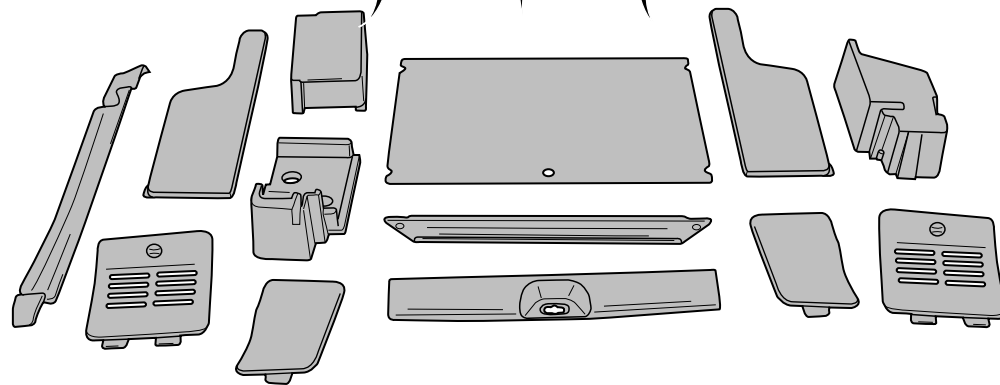
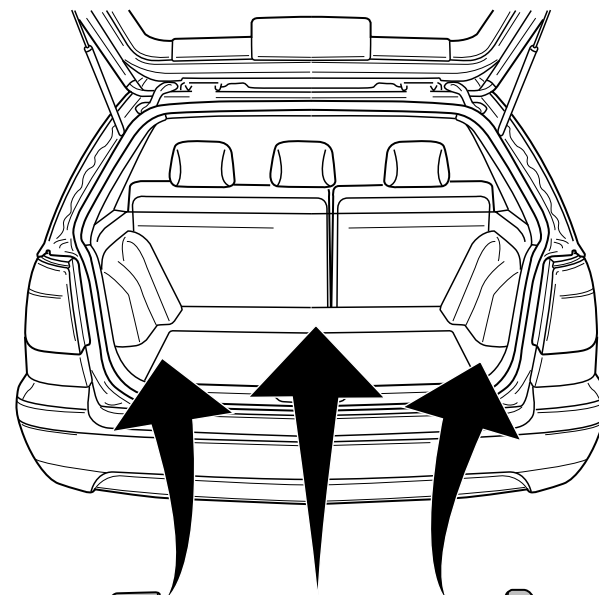

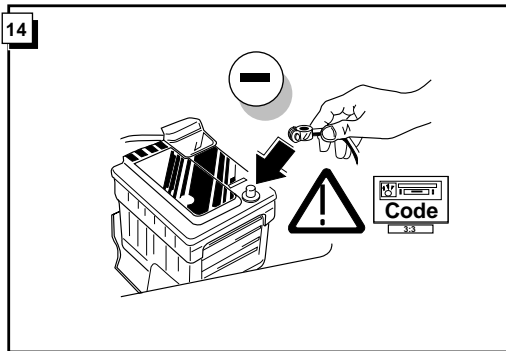
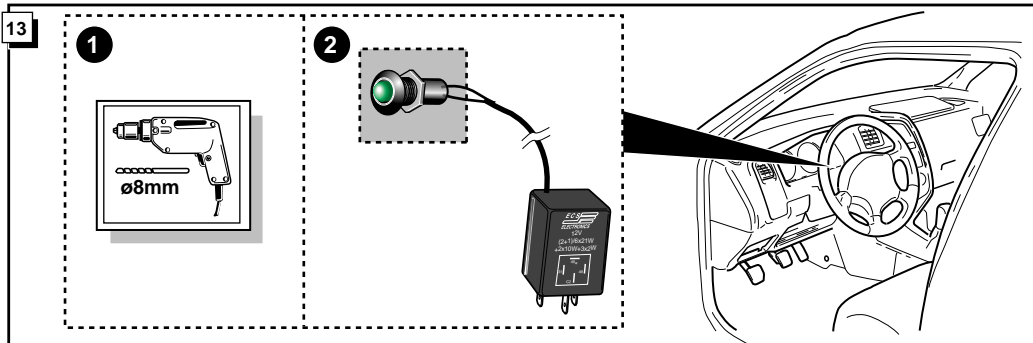
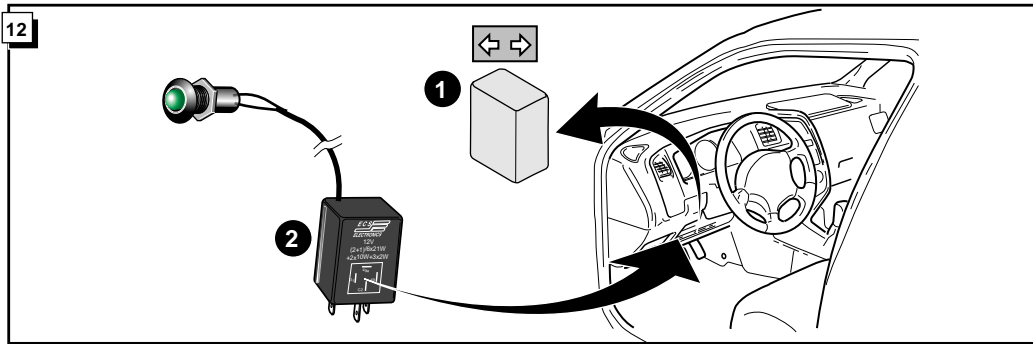

15

FUNKTIONEN KONTROLIEREN !
CONTRÔLER LES FONCTIONS !
CHECK FUNCTIONS !
CONTROLEER FUNCTIES !

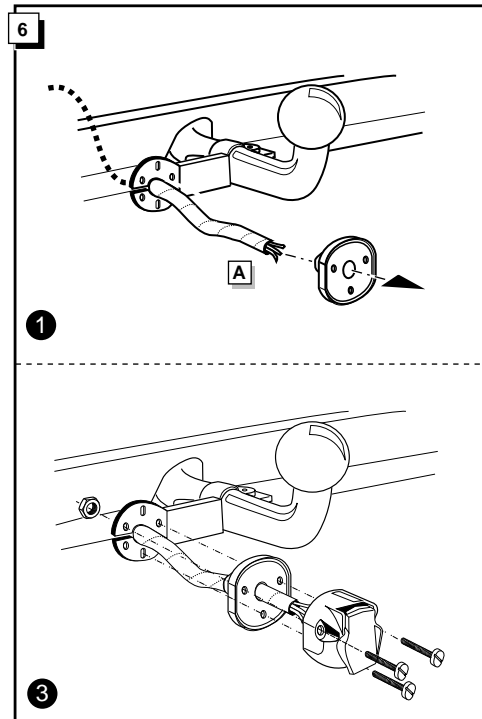
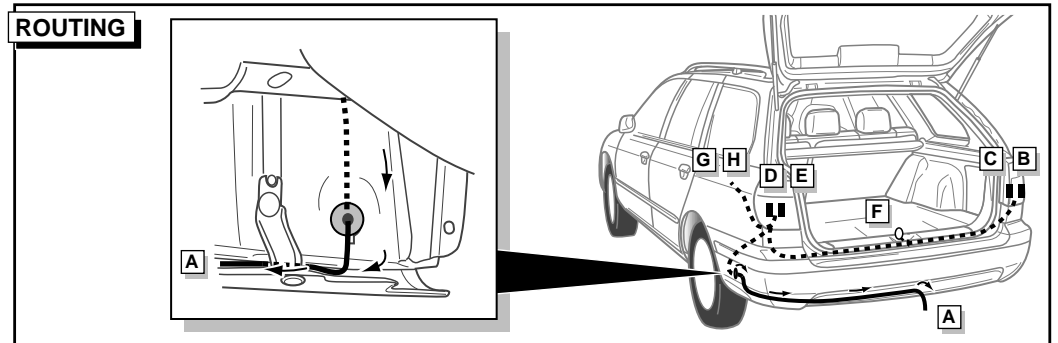
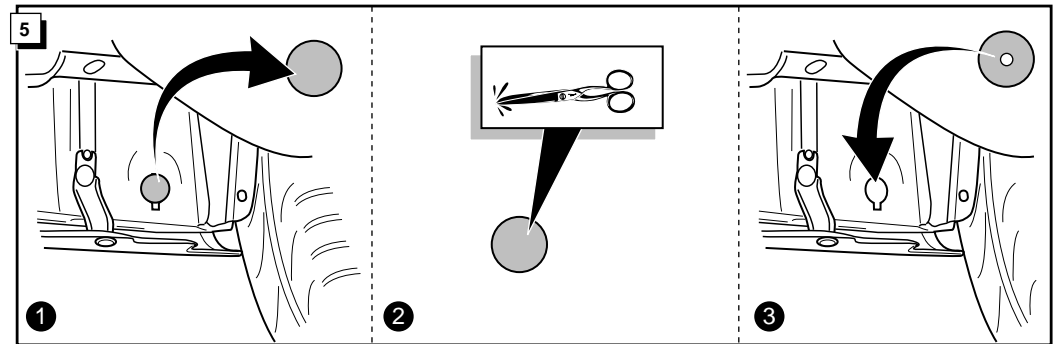
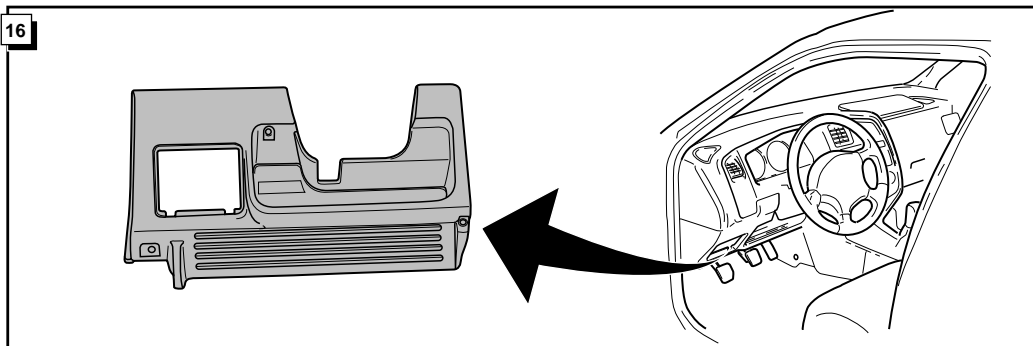

| | (D) | (FR) | (GB) | (NL) |
|----------|---------|--------|--------|-------|
| 1 = L | GELB | JAUNE | YELLOW | GEEL |
| 2 = 54-G | BLAU | BLEU | BLUE | BLAUW |
| 3 = 31 | WEIß | BLANC | WHITE | WIT |
| 4 = R | GRÜN | VERT | GREEN | GROEN |
| 5 = 58-R | BRAUN | MARRON | BROWN | BRUIN |
| 6 = 54 | ROT | ROUGE | RED | ROOD |
| 7 = 58-L | SCHWARZ | NOIR | BLACK | ZWART |
| 8 = 58-B | GRAU | GRIS | GREY | GRIJS |

