

**Einbauanleitung Elektrosatz  
Anhängervorrichtung mit 12-N Steckdose  
lt. DIN/ISO Norm 1724**

**Instructions de montage du faisceau  
électrique pour crochet d'attelage  
conforme à la norme  
DIN/ISO 1724 prise 12-N**

**Fitting instructions electric wiringkit  
towbar with 12-N socket up to  
DIN/ISO norm 1724**

**Montage-handleiding elektrokabelset voor  
trekhaak met 12-N contactdoos  
vlg. DIN/ISO norm 1724**

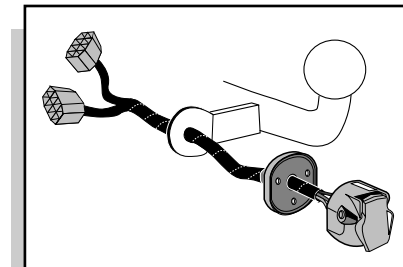

**HYUNDAI SONATA 1998- + 06/2001-**

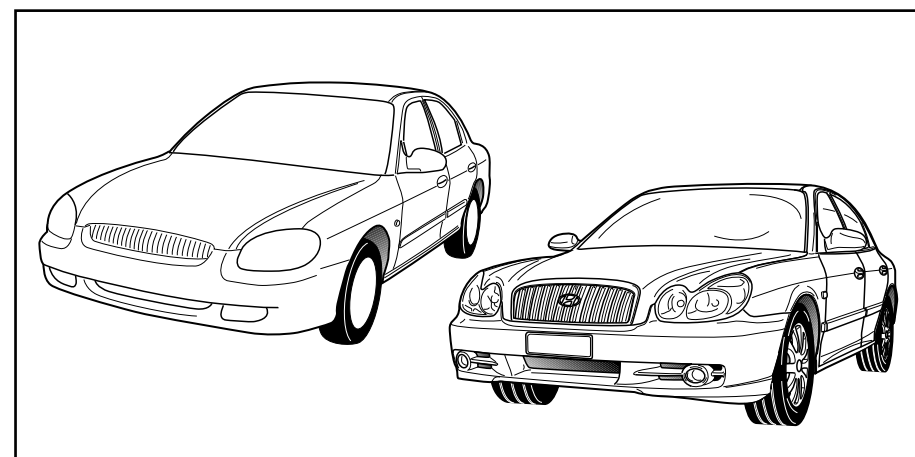

Bestel Nr.: HY-029-BL



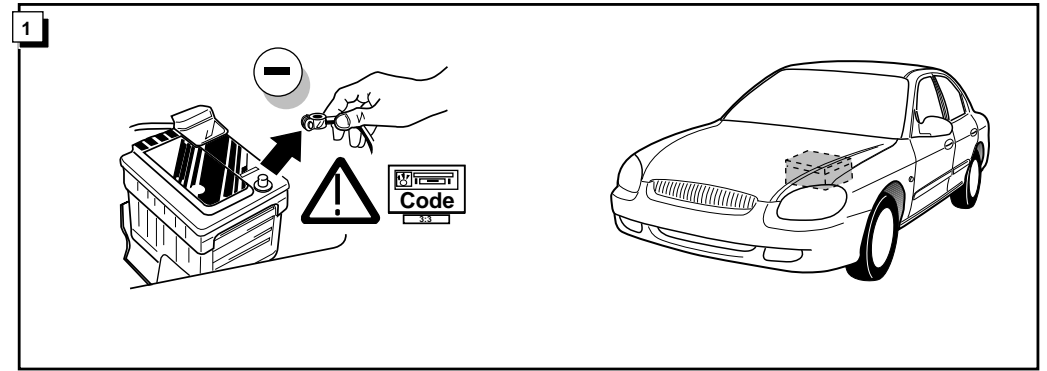
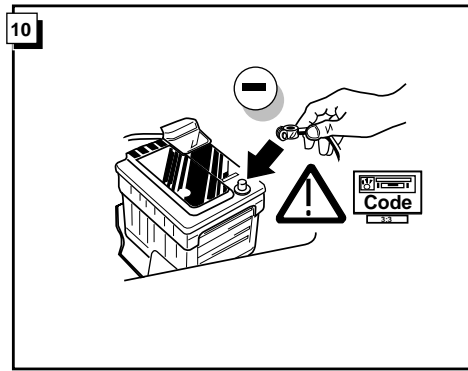
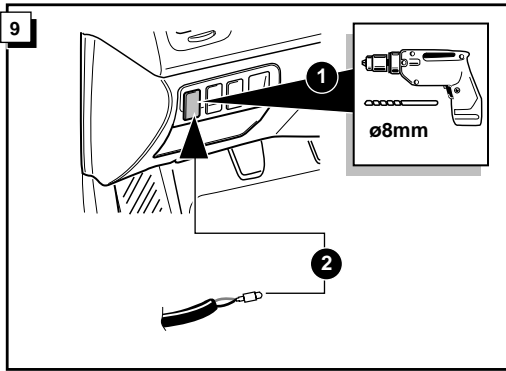

11

**! FUNKTIONEN KONTROLIEREN !**  
**! CONTRÔLER LES FONCTIONS !**  
**! CHECK FUNCTIONS !**  
**! CONTROLEER FUNCTIES !**

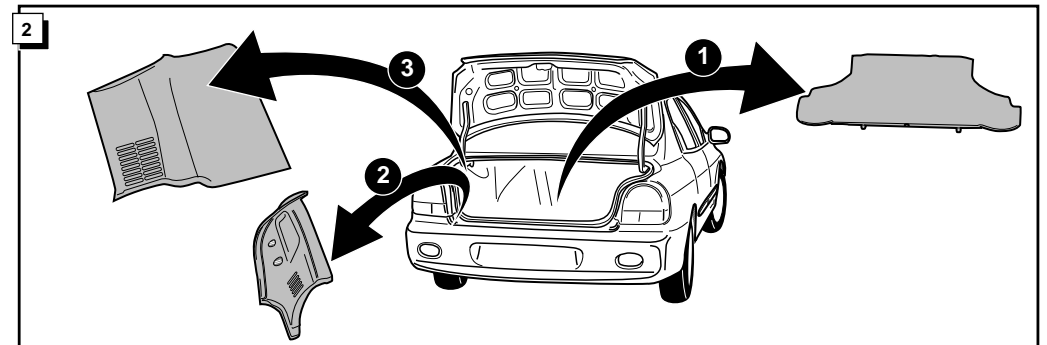
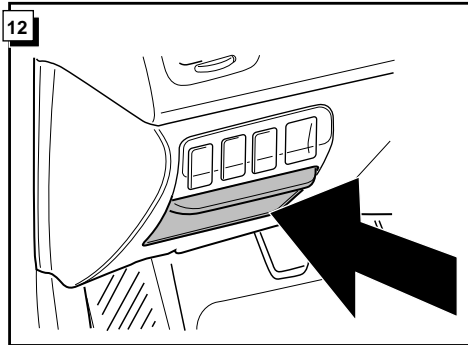

**INFO**

Die Kontrollleuchte blinkt, wenn beim angeschlossenen Anhänger die Blinker (3x21W) oder Warnblinkanlage (6x21W) eingeschaltet sind.

Le deuxième témoin de contrôle clignote lorsque les feux de détresses (6X21W) et les clignotants (3X21W) du véhicule sont allumés alors que la caravane/remorque est accouplée au véhicule.

By switching on flashers with the trailer connected (3x21W) or the warning lights (6x21W), the 2nd direction indicator light will flash.

Het controle-lampje knippert wanneer bij aangesloten aanhanger de knipperlichten (3x21W) of waarschuwingslichten (6x21W) ingeschakeld zijn.

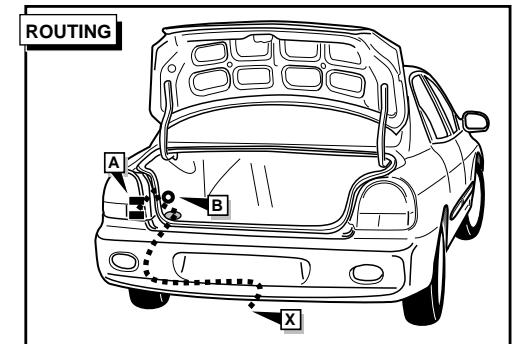
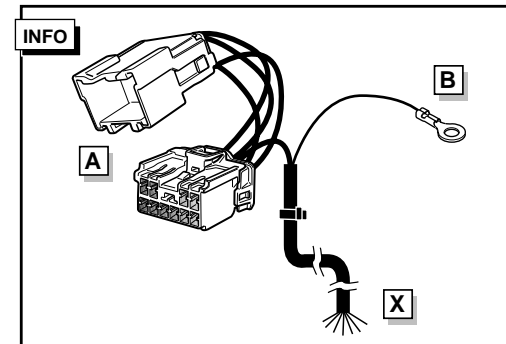
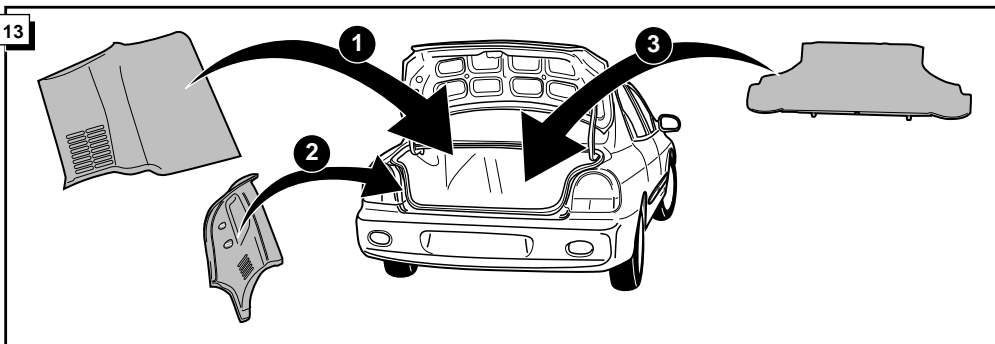
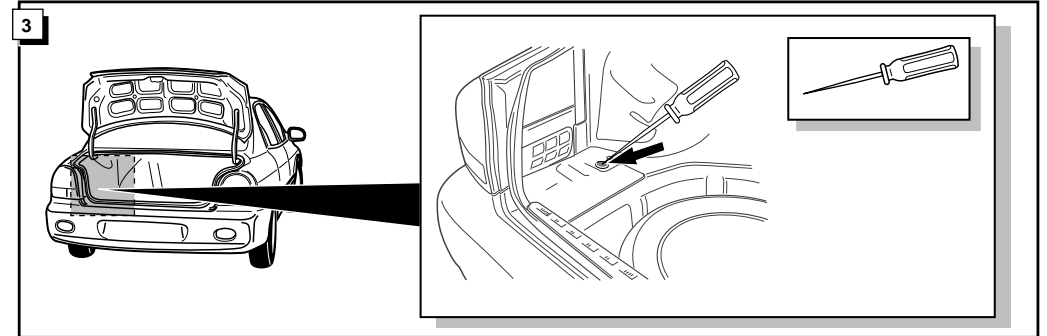

**INFO** Anschluß Steckdose / Connection de la prise / Socket connection / Contactdoos aansluiting

DIN/ISO 1724		D	F	GB	NL
	1/L	gelb	jaune	yellow	geel
	2	blau	bleu	blue	blauw
	3/31	weiß	blanc	white	wit
	4/R	grün	vert	green	groen
	5/58-R	braun	marron	brown	bruin
	6/54	rot	rouge	red	rood
	7/58-L	schwarz	noir	black	zwart
	8/58-b	grau	gris	grey	grijs

