

1

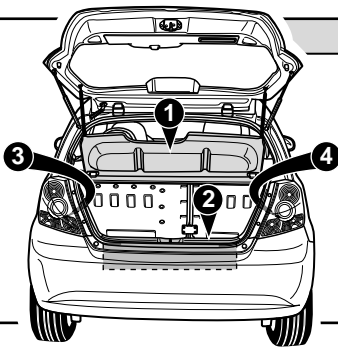

D

Abmontieren Teile

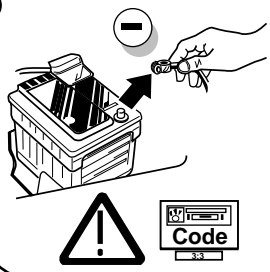
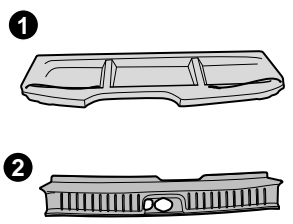

F

Démontez les parts

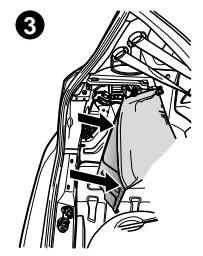

GB

Remove linings

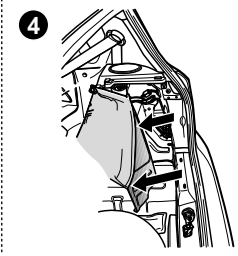

NL

Verwijder onderdelen

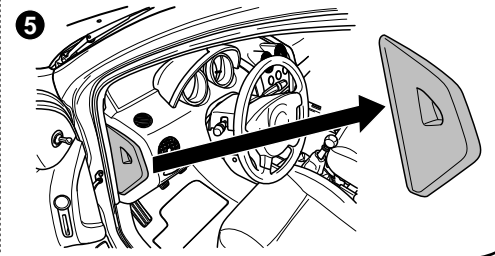

INFO

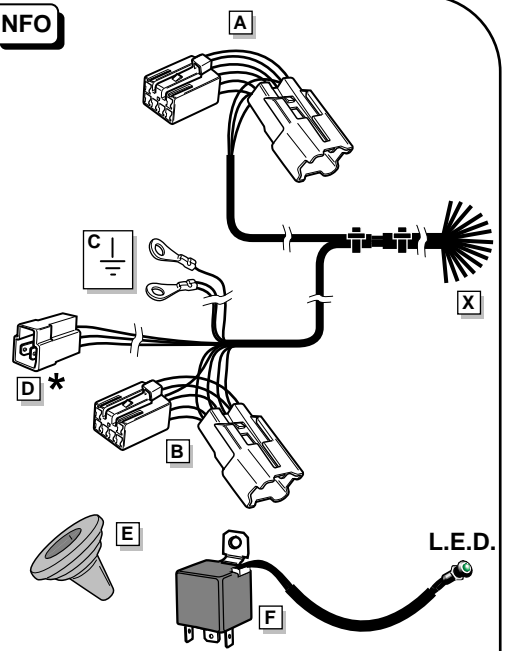

*
 D ist eine Vorbereitung für 30+ , 15+ () und
 D est une préparation pour 30+ , 15+ () et
 D is a preparation for 30+ , 15+ () and
 D is een voorbereiding voor 30+ , 15+ () en

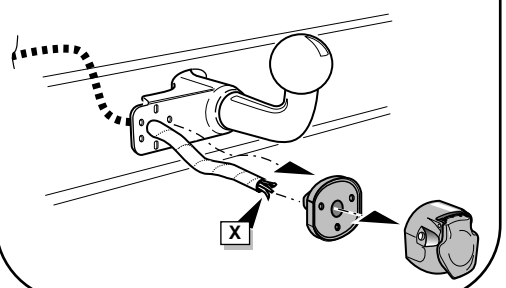

ROUTING

