

# 01-126 - 304137600001 / 5284 - 304136600001

**ATTENTION : (pour connaître les caractéristiques d'utilisation consulter la carte grise).**

Installé suivant nos recommandations, cet attelage vous donnera entière satisfaction. Nous dégageons toute responsabilité en cas de transformation ou d'utilisation illicite de celui-ci

**FR**

**ACHTUNG: (Nutzungsmerkmale : siehe Fahrzeugschein)**

Diese Anhängervorrichtung wird Sie voll zufrieden stellen, wenn Sie unsere Montageanleitung befolgen.  
Im Falle der unerlaubten Veränderung oder des unerlaubten Gebrauchs lehnen wir jede Haftung ab.

**DE**

**PLEASE NOTE : (to familiarise yourself with the operating characteristics refer to the log).**

If this tow bar is fitted in accordance with our recommendations it will give a completely satisfaction.  
We cannot accept any responsibility in the event of changes to or improper use of this item.

**EN**

**BEMÆRK : (for yderligere oplysninger om anvendelsesforhold henvises der til registreringsattesten)**

Hvis dette anhængertræk monteres i henhold til vores anvisninger, vil det være til din fulde tilfredshed.  
Vi fratægger os ethvert ansvar ved ulovlig ændring eller brug af anhængertrækket.

**DA**

**ΠΡΟΣΟΧΗ : (για να πληροφορηθείτε τα χαρακτηριστικά χρήσης συμβουλευτείτε την γκριζα κάρτα)**

Εγκατεστημένο σύμφωνα με τις συστάσεις μας, αυτό το σύστημα ρυμούλκησης θα σας ικανοποιήσει πλήρως. Απεκδυόμαστε πάσης ευθύνης σε περίπτωση μετατροπής ή παράνομης χρήσης αυτού.

**EL**

**ATENCIÓN: (para conocer las características de utilización, consultar el permiso de circulación)**

Instalado siguiendo nuestras recomendaciones, este enganche le dará total satisfacción. No asumiremos ninguna responsabilidad en caso de que haya sido transformado o utilizado ilícitamente.

**ES**

**UWAGA (charakterystyki użytkowania należy sprawdzić w dowodzie rejestracyjnym)**

Dyszel holowniczy będzie funkcjonował we właściwy sposób po zainstalowaniu go zgodnie z zaleceniami. Nie ponosimy żadnej odpowiedzialności w przypadku wprowadzenia zmian lub niedozwolonego użycia

**PL**

**HUOMIO: (käyttöominaisuuksiin tutustumiseksi on katsottava rekisteriotetta)**

Suosituksen mukaan asennettuna tämä vetokoukku täyttää odotuksesi.  
Emme ota vastuuta, jos laitetta muutetaan tai käytetään ohjeiden vastaisesti.

**FI**

**ATTENZIONE : (per conoscere le caratteristiche d'uso consultare il libretto di ircolazione)**

Installato seguendo le nostre raccomandazioni, questo gancio da traino vi lascerà completamente soddisfatti.  
Respingiamo ogni responsabilità in caso di trasformazione o utilizzo illecito dello stesso.

**IT**

**LET OP : (voor gebruikskennmerken het kentekenbewijs raadplegen)**

Indien u de koppeling volgens onze aanbevelingen heeft geïnstalleerd, zal het u tot volle tevredenheid stemmen. Wij stellen ons niet aansprakelijk in geval van wijziging of onrechtmatig gebruik.

**NL**

**ADVARSEL: (for kunnskap om bruksegenskapene, se vognkortet)**

Ved å installere innretningen i samsvar med våre anbefalinger vil du få maksimalt utbytte av dette tilhengerfestet. Vi fraskriver oss alt ansvar hvis tilhengerfestet endres eller brukes på ulovlig måte.

**NO**

**POZOR: (užívateľské charakteristiky naleznete v technickém průkazu)**

Tažné zařízení instalované dle našich doporučení vás plně uspokojí. V případě přestavby nebo neoprávněného užívání se zbavujeme veškeré odpovědnosti

**CZ**

**VARNING: (Läs igenom det grå bladet för att ta reda på rådande användningsvillkor)**

Om du monterar produkten enligt våra anvisningar kommer du uppnå bästa möjliga resultat. Vi avsäger oss allt ansvar i de fall kunden inte följer våra anvisningar fullt ut.

**SV**

**FIGYELEM : (a használati jellegzetességeket a forgalmi engedélyből ismerheti meg)**

A vonóhorog előírásainak megfelelő felszerelés esetén a terméket teljes elégedettséggel használhatja. A termék átalakítása vagy tiltott használata esetén semmilyen felelősséget nem vállalunk.

**HU**

**ВНИМАНИЕ : (чтобы ознакомиться с рабочими характеристиками, изучите технический паспорт автомашины)**

Установленное при соблюдении рекомендаций, данное тягово-сцепное устройство в полной мере удовлетворит ваши потребности. Производитель не несет никакой ответственности в случае деформации или

**RU**



**SIARR**

**5284  
SI100**

**01 - 126  
SI099**

**WESTFALIA**

**30413660001**

**30413760001**



**C3 DS3**

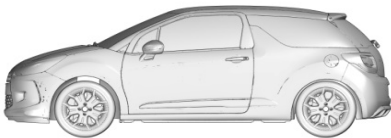

1 665 kg



1 225 kg



54 kg



6,93 kN



9427-CJ : 15,12 kg

9427-CK : 16,42 kg

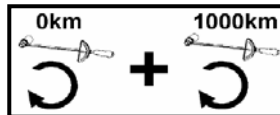
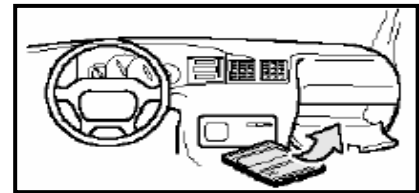

e24\*94/20\*00\*0152 - SI099

e24\*94/20\*00\*0147 - SI100

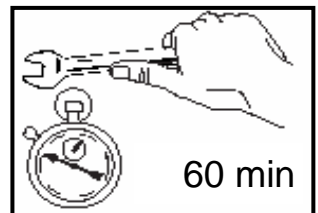

60 min

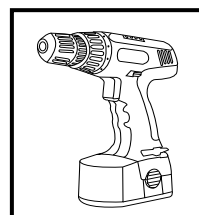
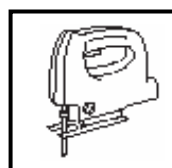
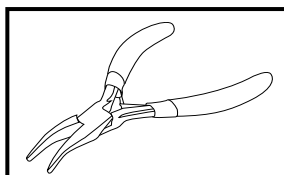
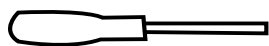
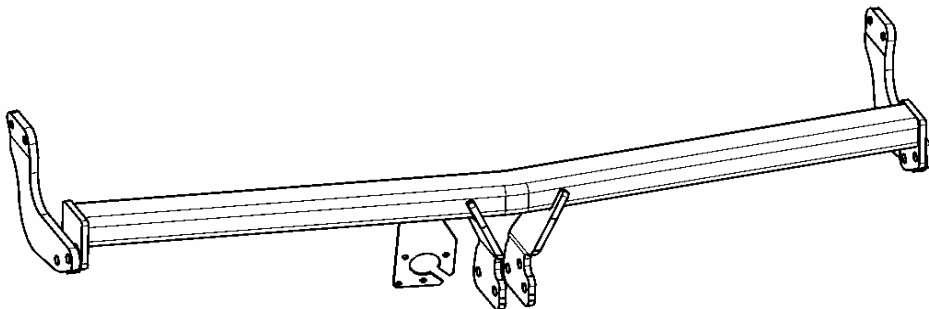

10-16-17-18-19-24

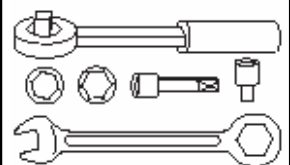

01-126 / 5284







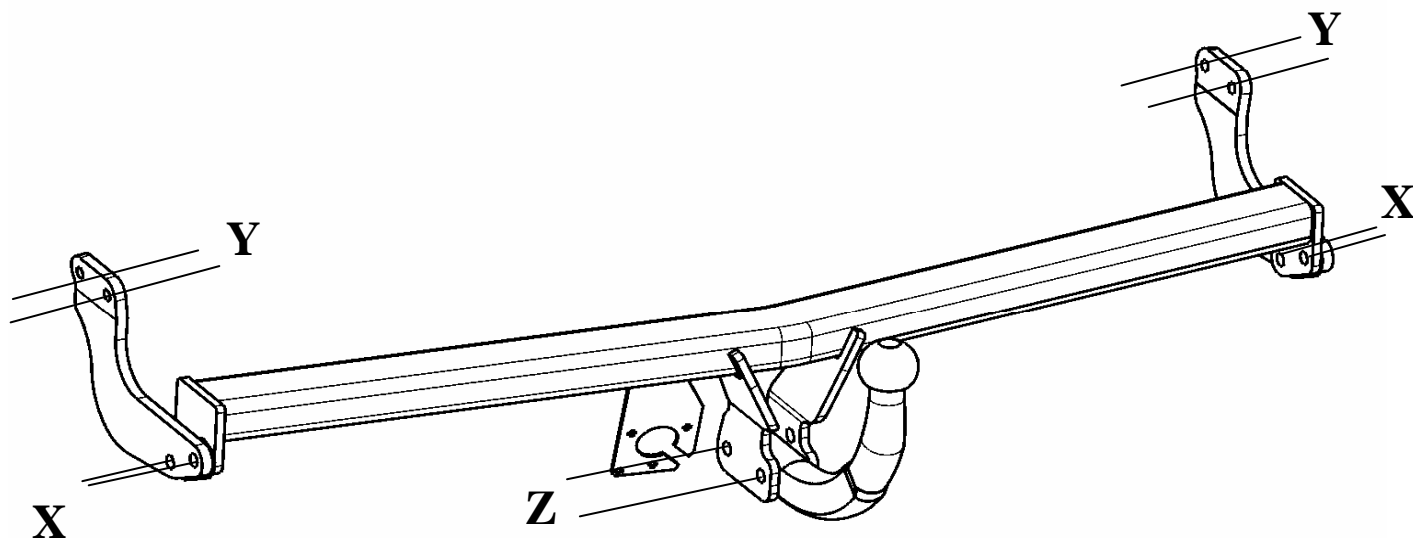

Indice A

26.10.2009

1 / 12







5284

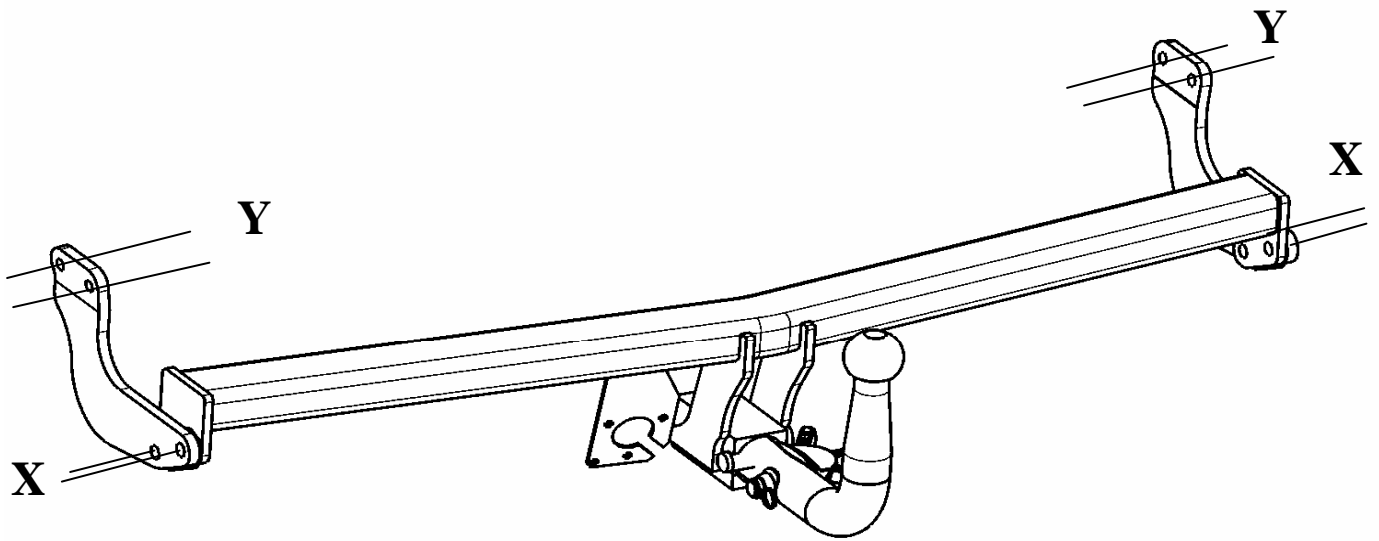

<b>X</b>	 HM12x40 - c18 - 65Nm	x 4
	 CS12	x 4
	 M12 - c110	x 4
<b>Y</b>	 HM10x30 - c110.9 - 55Nm	x 4
	 CS10/27	x 4
<b>Z</b>	 HM12x65 - c110.9 - 95Nm	x 2
	 CS12	x 2
	 M12 - c110	x 2
		x 2

01 - 126



<b>X</b>	 HM12x40 - c18.8 - 65Nm	x 4
	 CS 12	x 4
	 M12	x 4
<b>Y</b>	 HM10x30 - c110.9 - 55Nm	x 4
	 CS 10	x 4
		x 2

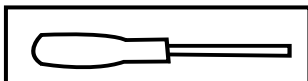
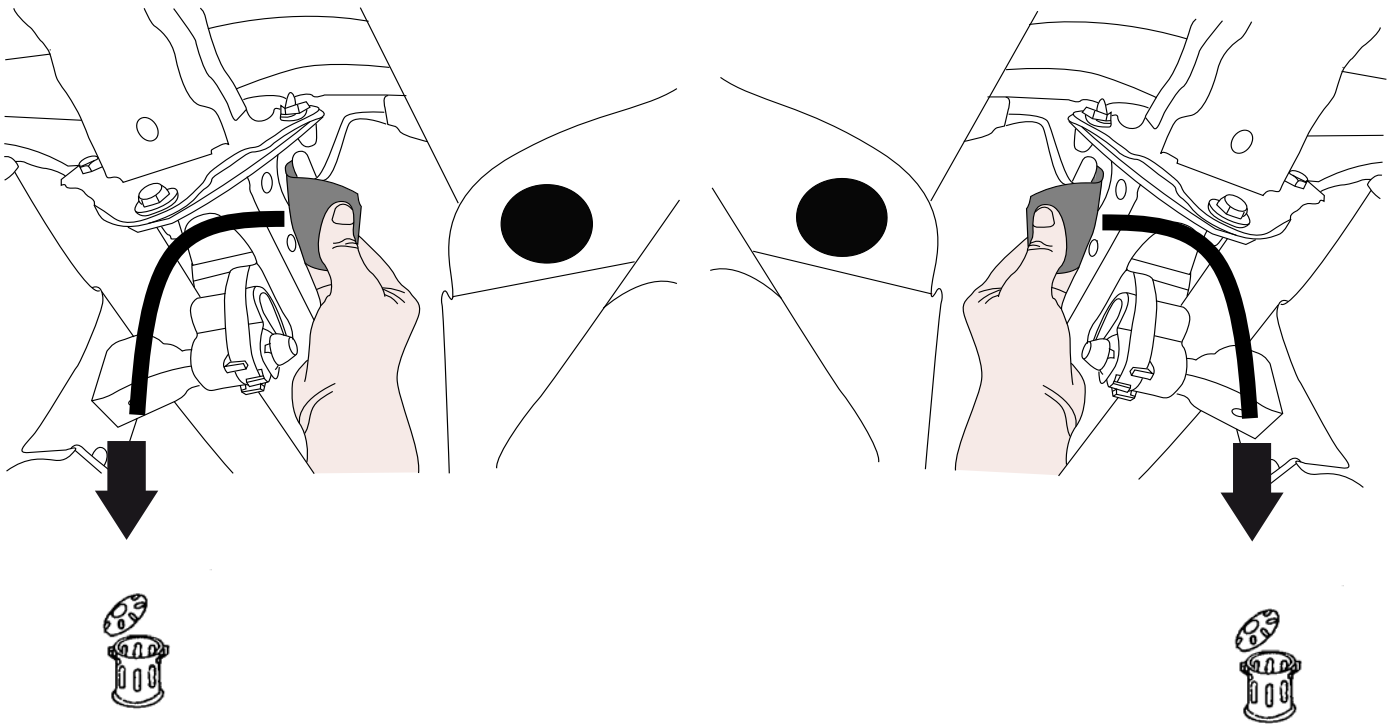
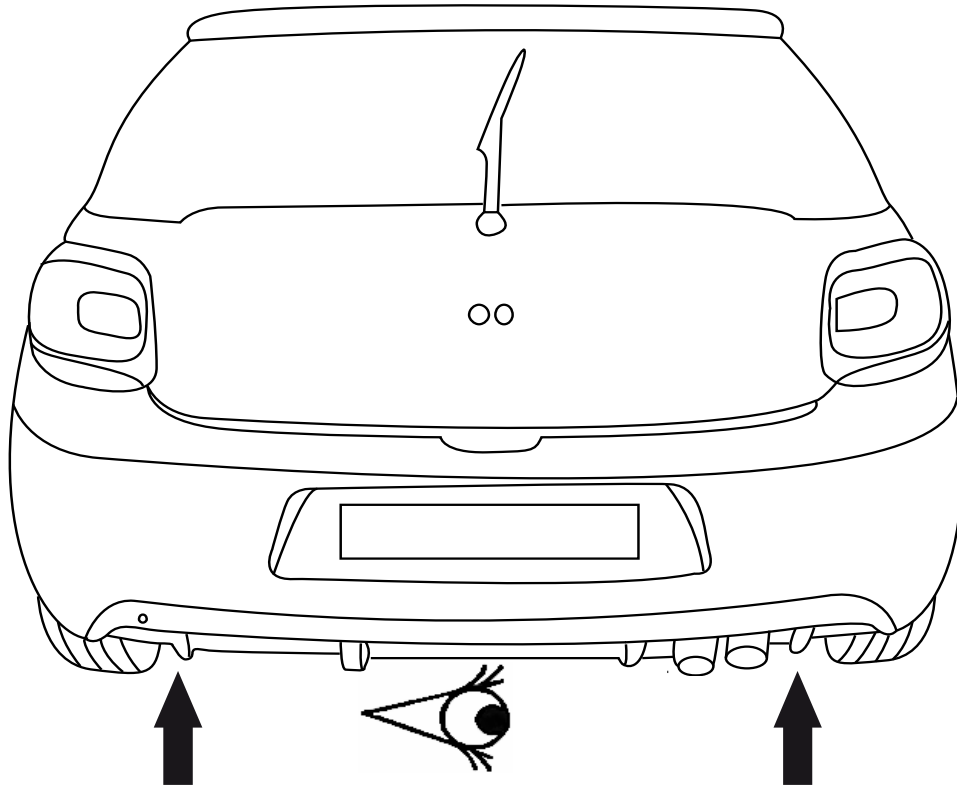

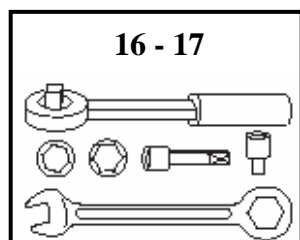
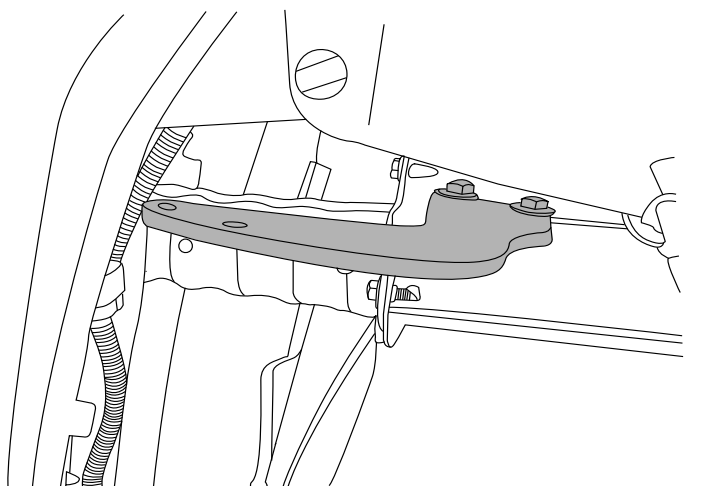
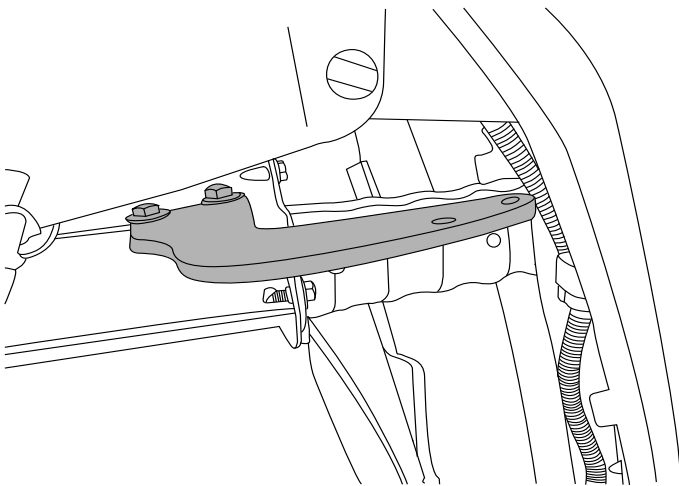
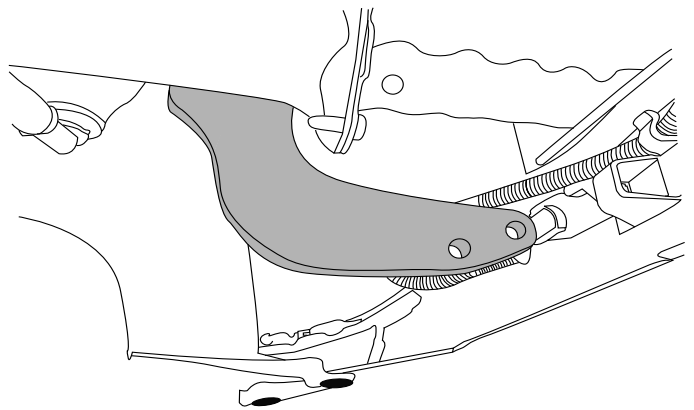
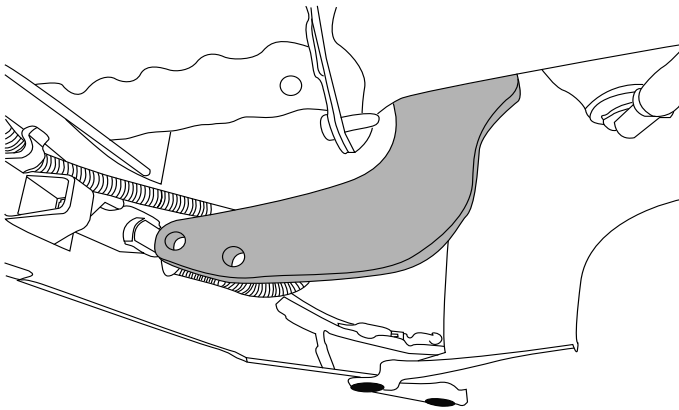
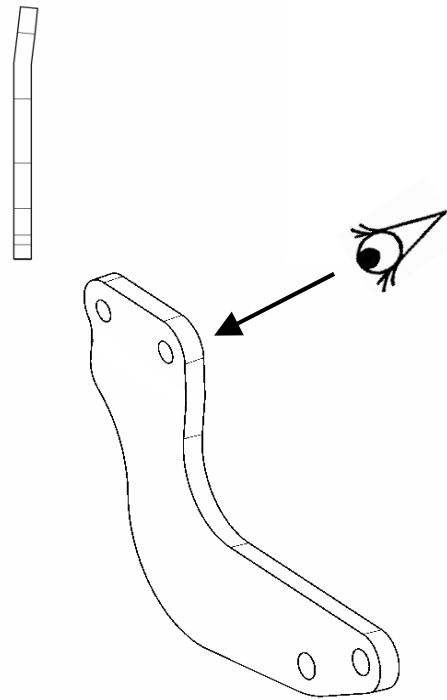
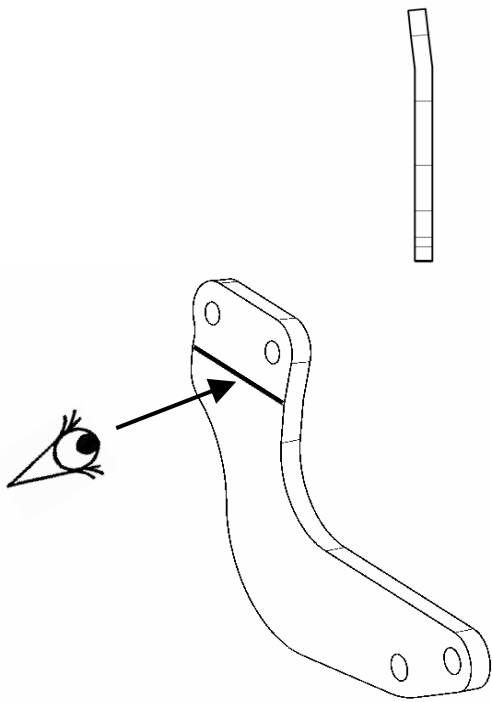

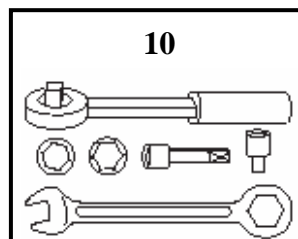
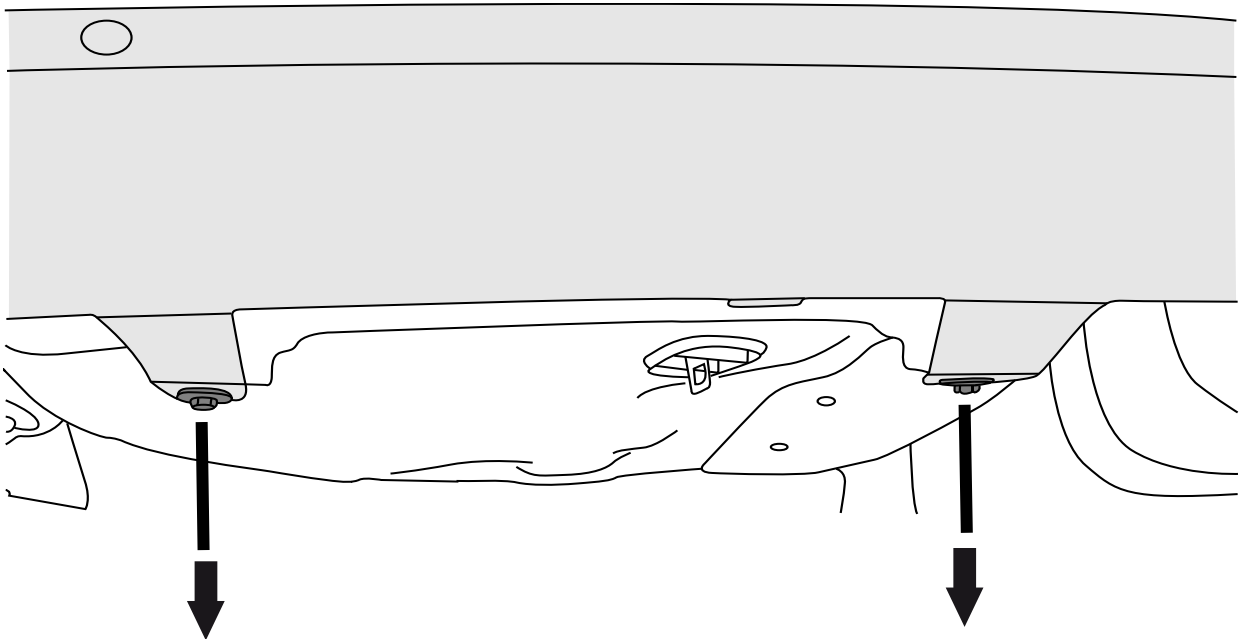
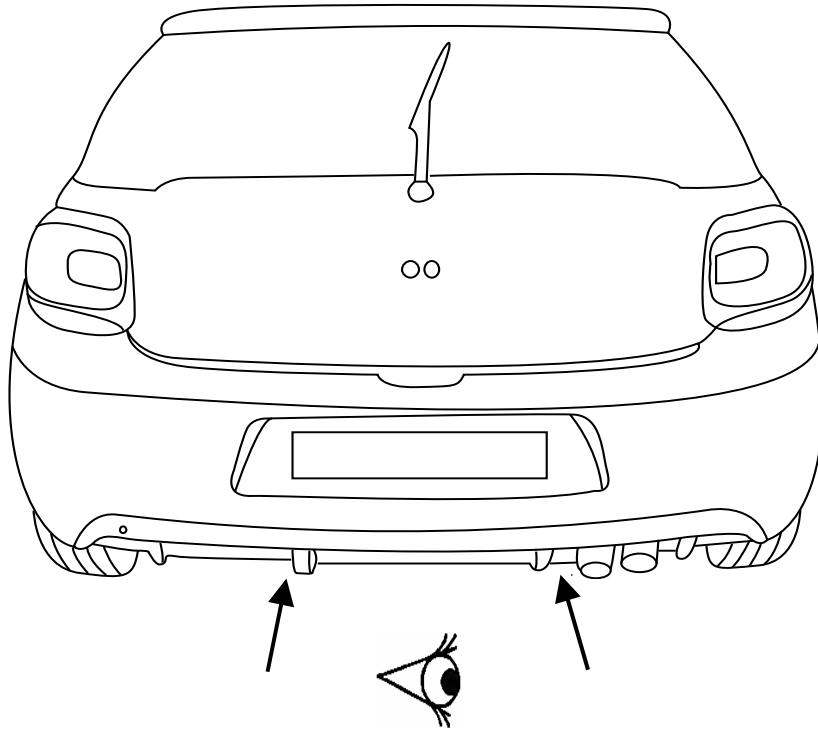

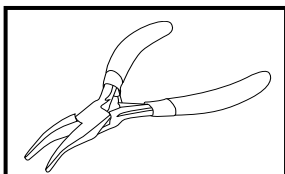
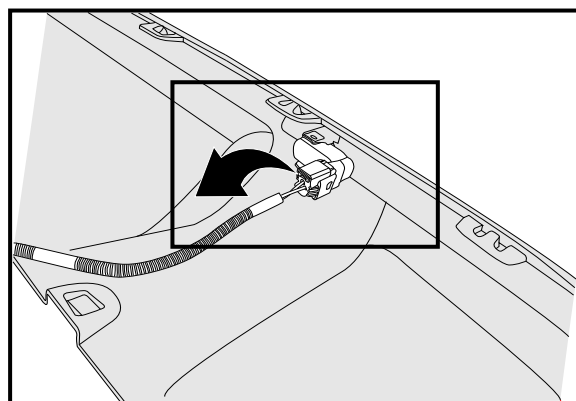
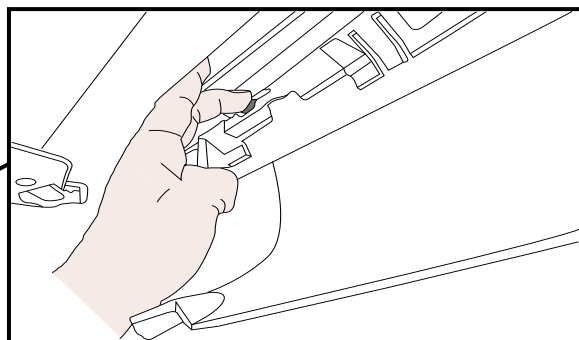
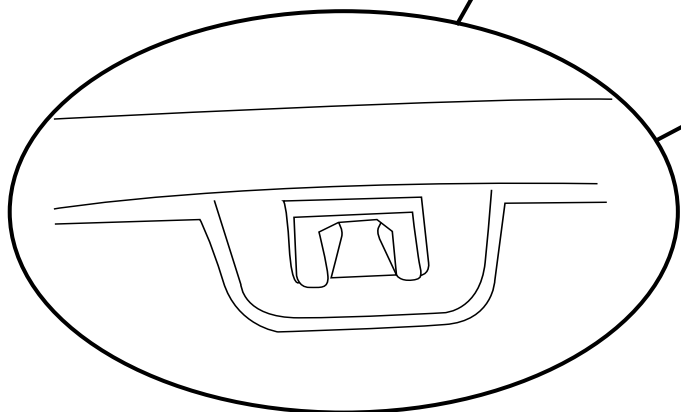
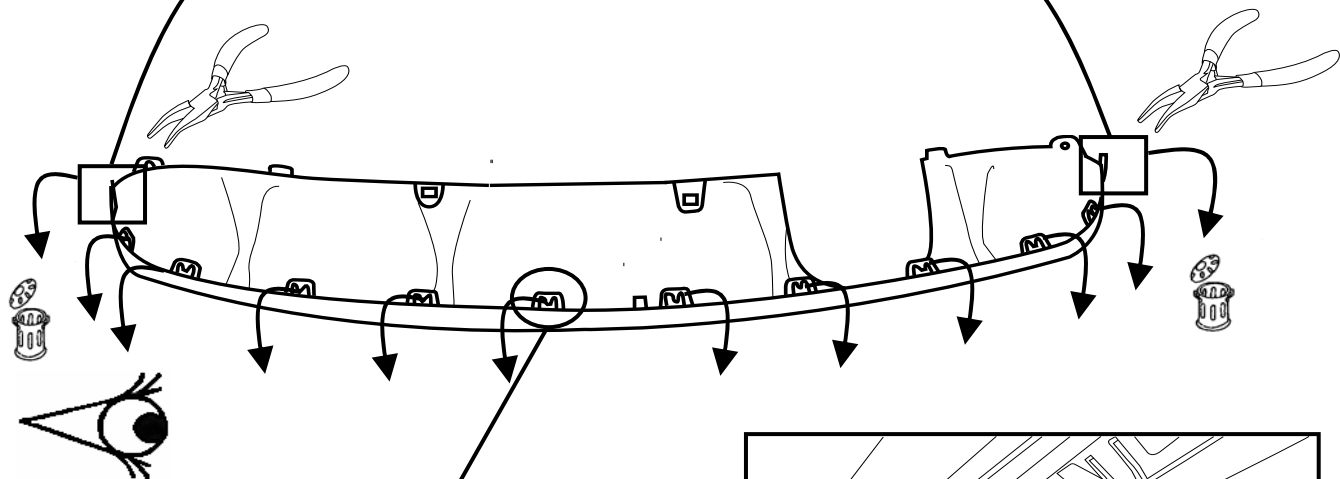
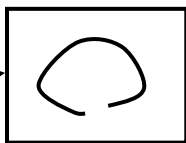
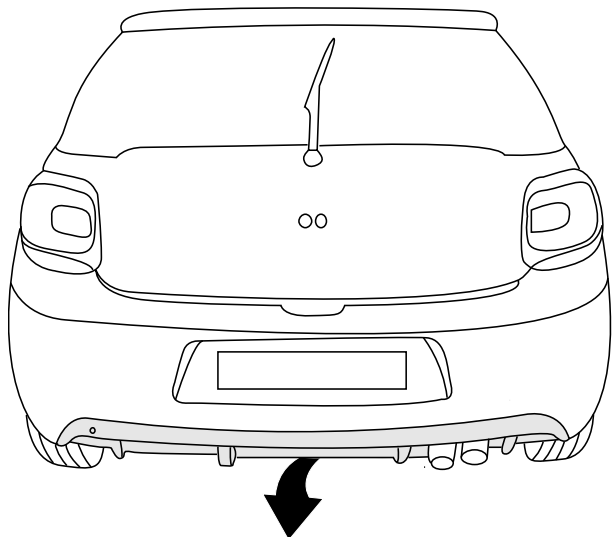
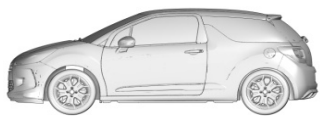



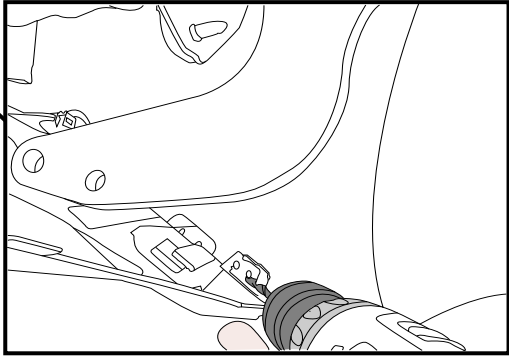
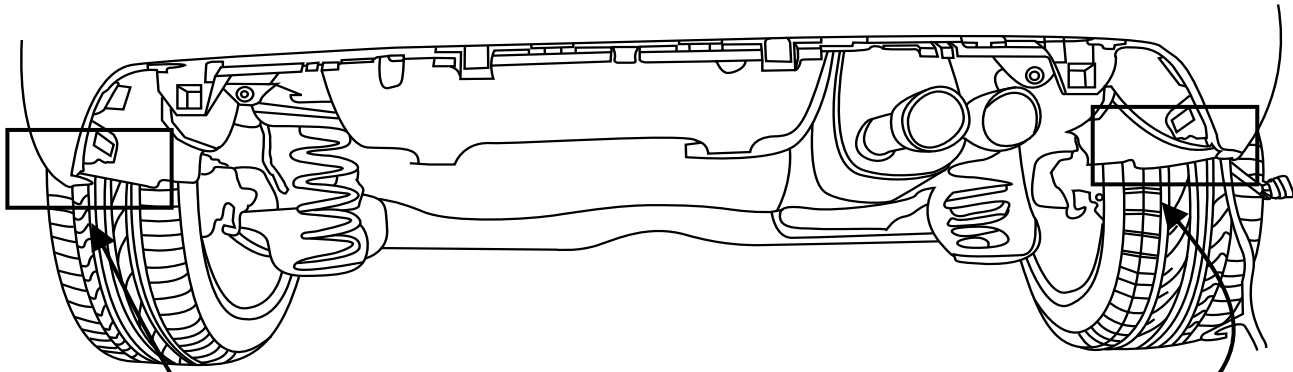

Ø 3 mm

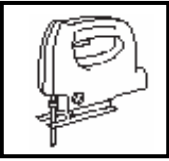
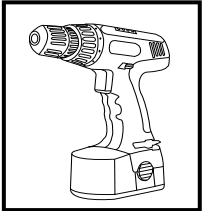
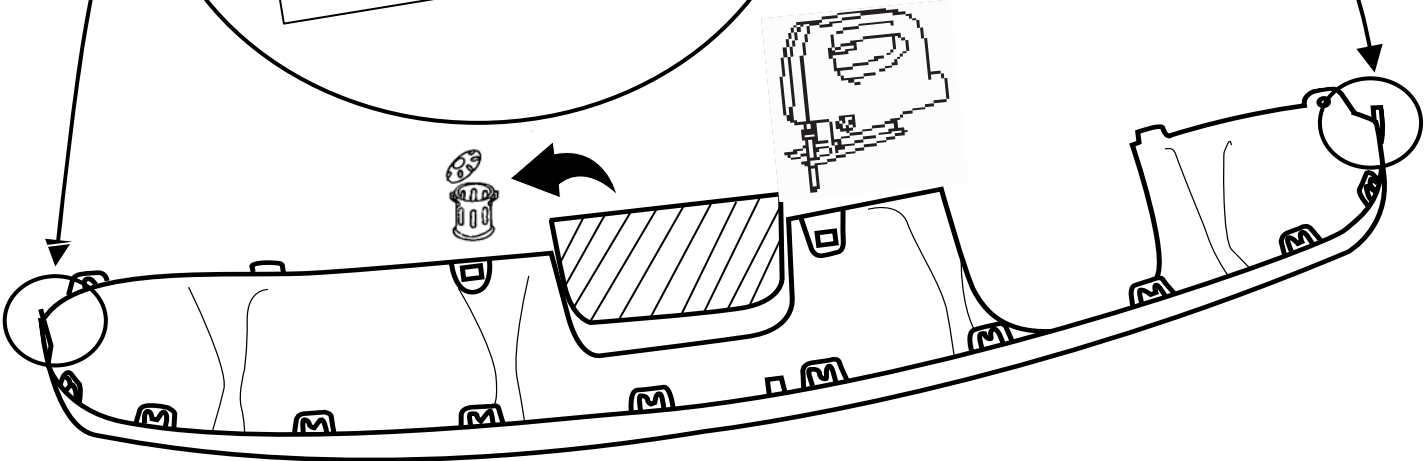
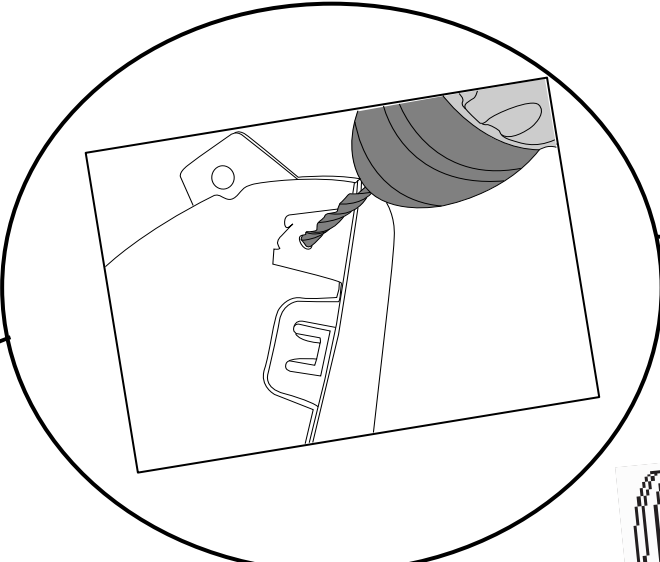
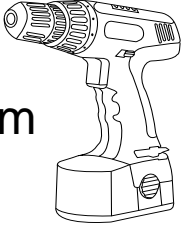

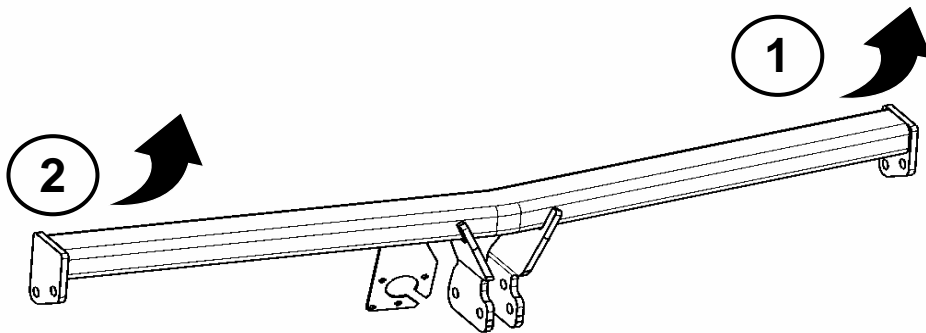
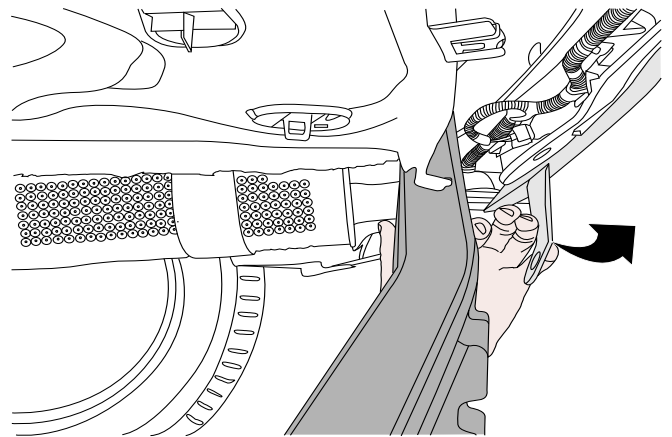
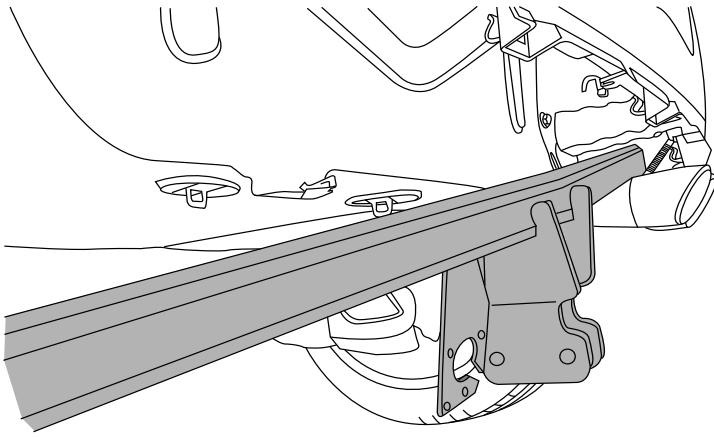
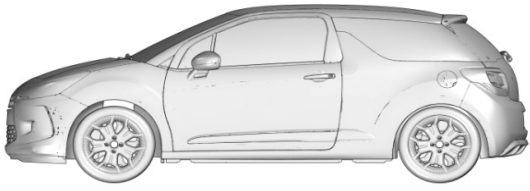



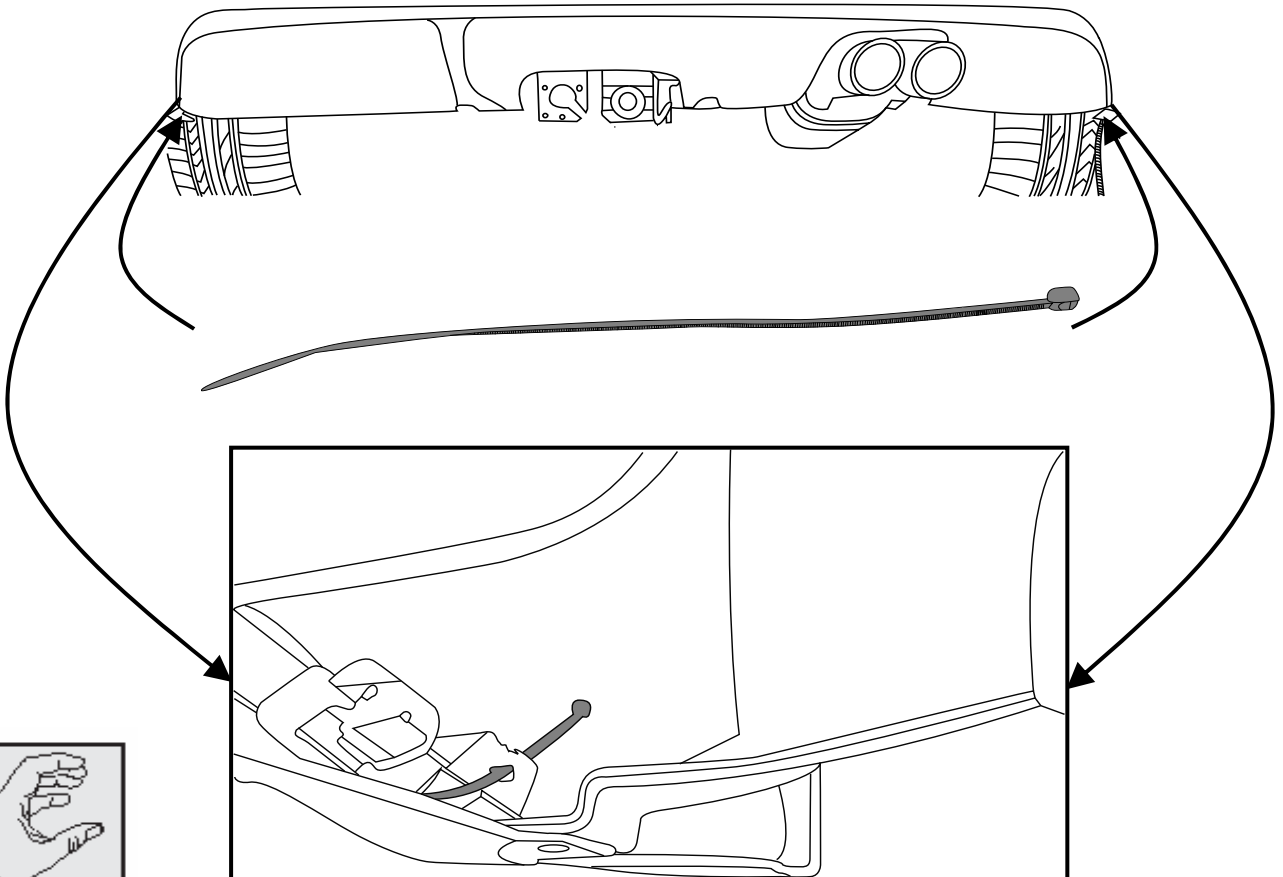
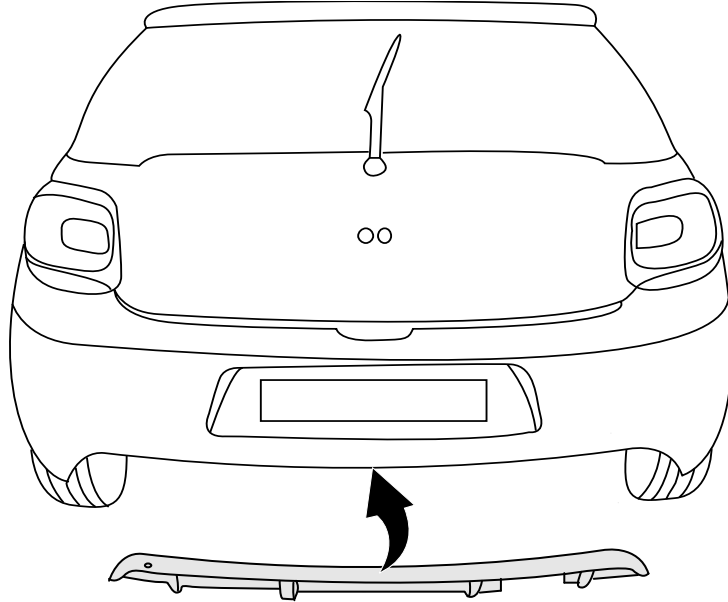
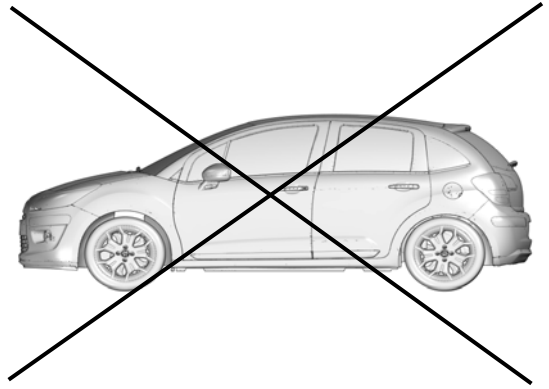
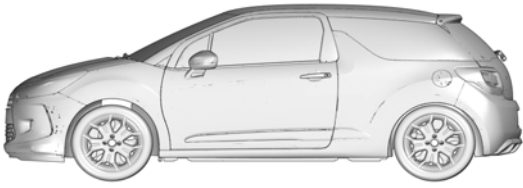

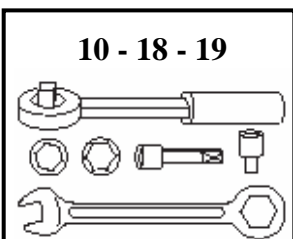
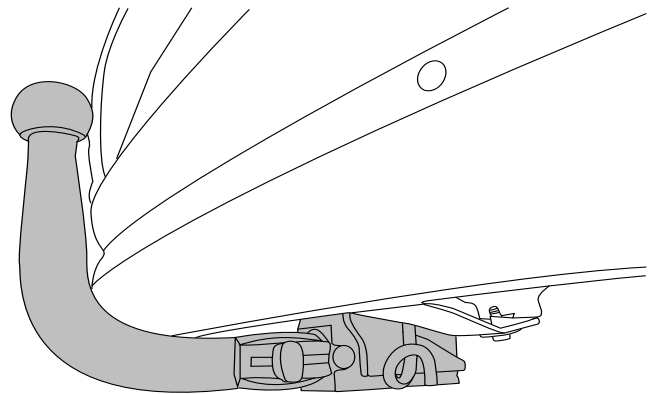
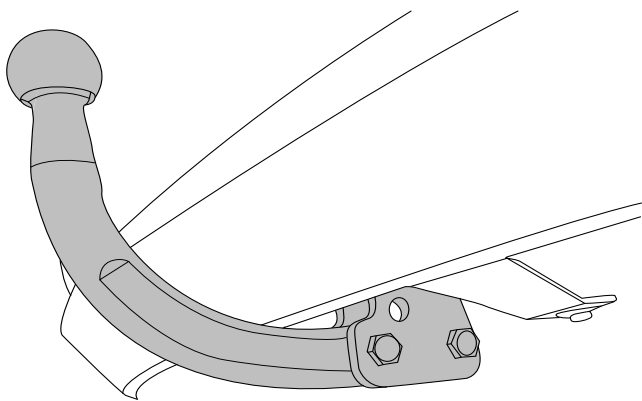
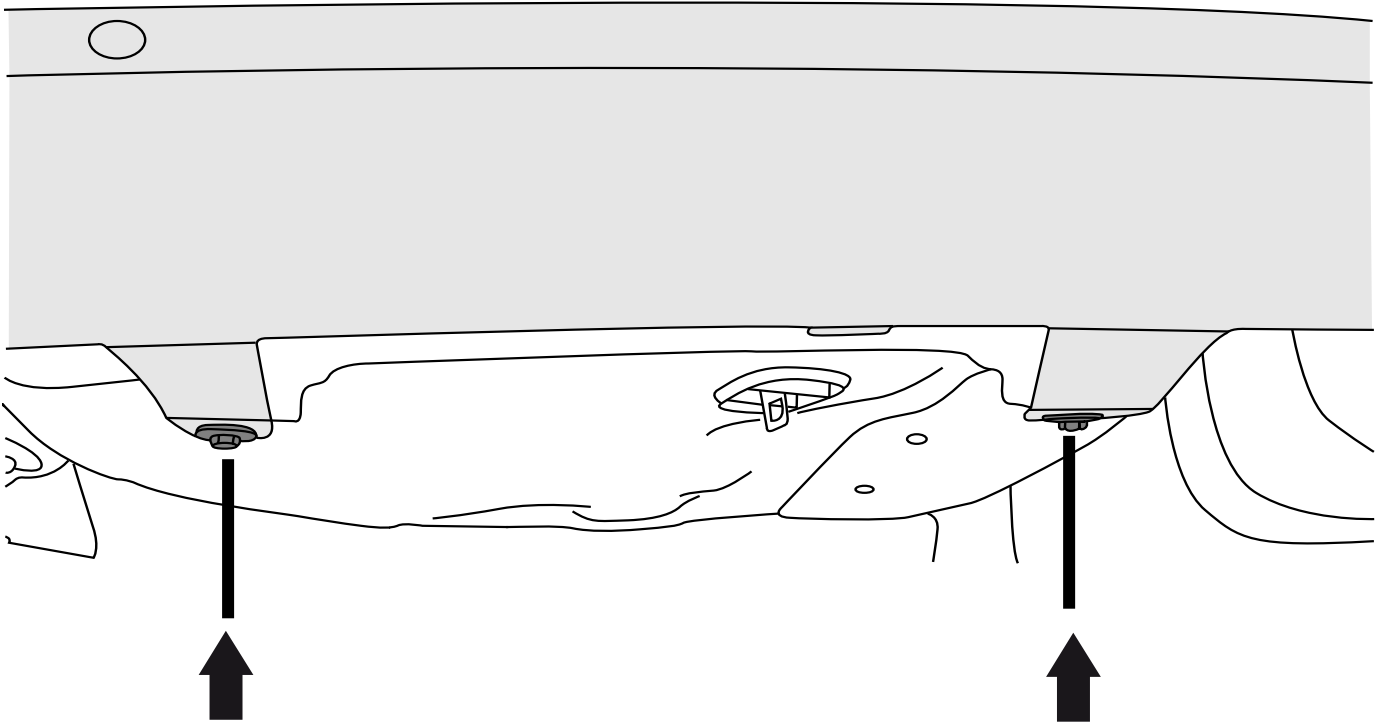
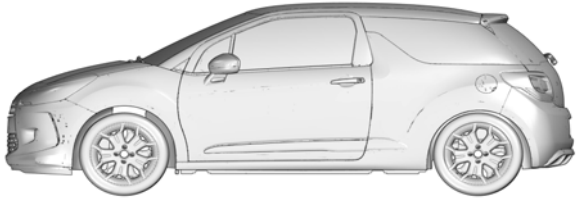

Dispositivo di traino tipo : **5284 / 01-126**  
Per autoveicolo : **Citroën C3 DS3**  
Tipo funzionale : **SA / SC / SR**



Classe e tipo di attacco : **A50-X**  
Omologazione : **e24\*94/20\*00\*0152 (5284) / e24\*94/20\*00\*0147 (01-126)**  
Valore D : **6,93 kN**  
Carico verticale max. S : **54 kg**  
Massa rimorchiabile : vedi carta di circolazione dell'autoveicolo

In base alla Direttiva europea 94/20, la massa massima rimorchiabile del dispositivo di traino è determinata dal valore di prova "D" così definito :

$$D = (T \times C) / (T + C) \times 0,00981 = 6,93 \text{ kN}$$

dove : T = Massa complessiva max. della motrice (in kg) e C = Massa rimorchiabile max. della motrice (in kg)

#### DICHIARAZIONE DI CORRETTO MONTAGGIO :

la sottoscritta Ditta dichiara che il dispositivo di traino tipo \_\_\_\_\_ è stato installato a regola d'arte, nel rispetto dei punti d'attacco e delle prescrizioni fornite dalla Casa costruttrice

sul veicolo \_\_\_\_\_

targato \_\_\_\_\_

li \_\_\_\_\_

Si dichiara inoltre di aver informato l'utente del veicolo sull'USO e MANUTENZIONE del dispositivo stesso.

timbro et firma

