

MVG: 0595 A

Mazda CX-5 (KE)

E Instrucciones de montaje

D Einbauanleitung

GB Installation instruction

F Notice de montage

NL Inbouw instructie

S Monteringsanvisning

CZ Návod k montáži

I Istruzioni di montaggio

An der Wasserwiese 1
D-52249 Eschweiler

E-mail: info@mvg-ahk.de
Internet: www.mvg-ahk.de

Tel.: 0049 (0)2403/7902-60
Fax: 0049 (0)2403/7902-99

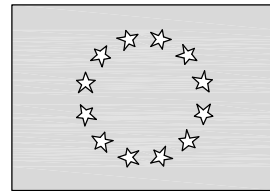
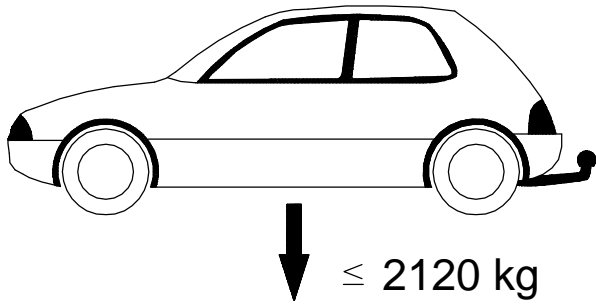

EG
e13 * 2007/46 * 1247

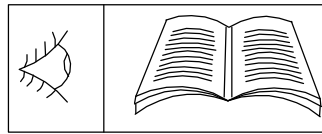

$$D = 11,0 \text{ kN}$$

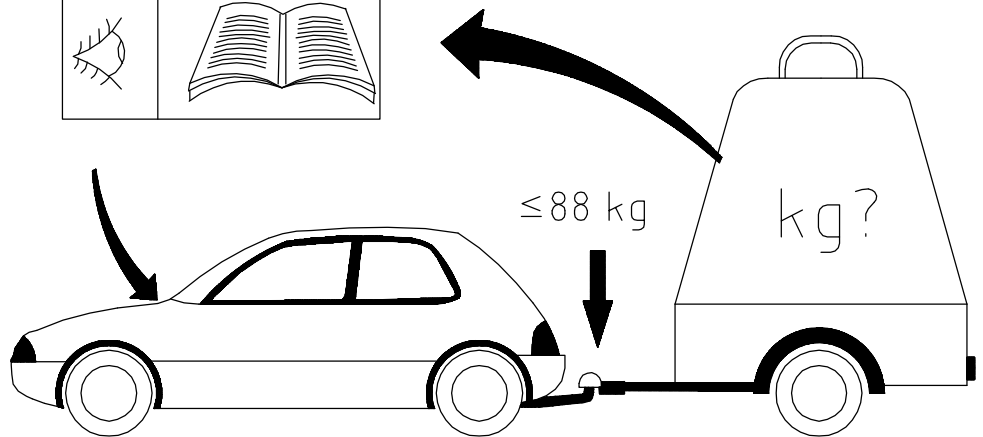

$$g = 9,81 \text{ m/s}^2$$



$$D = \frac{T \times R}{1000 \times (T+R)} \times g$$

$$T = \frac{R \times D \times 1000}{g \times R - 1000 \times D} \times g$$

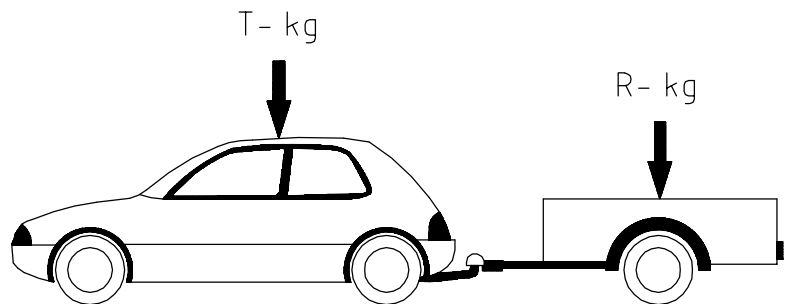
$$R = \frac{T \times D \times 1000}{g \times T - 1000 \times D}$$

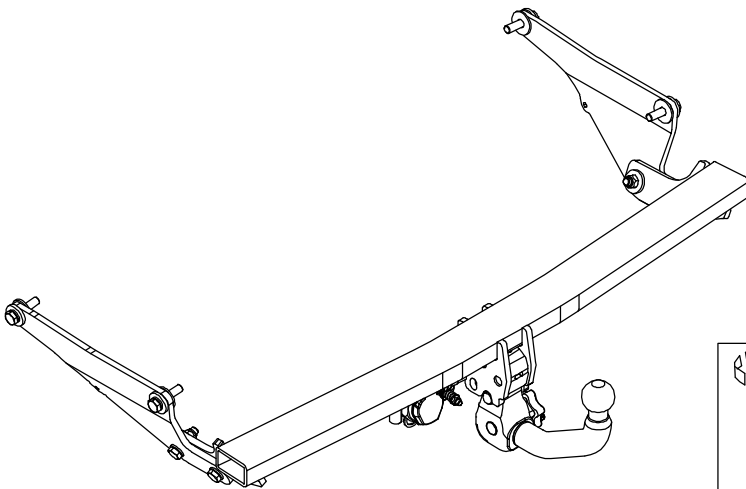
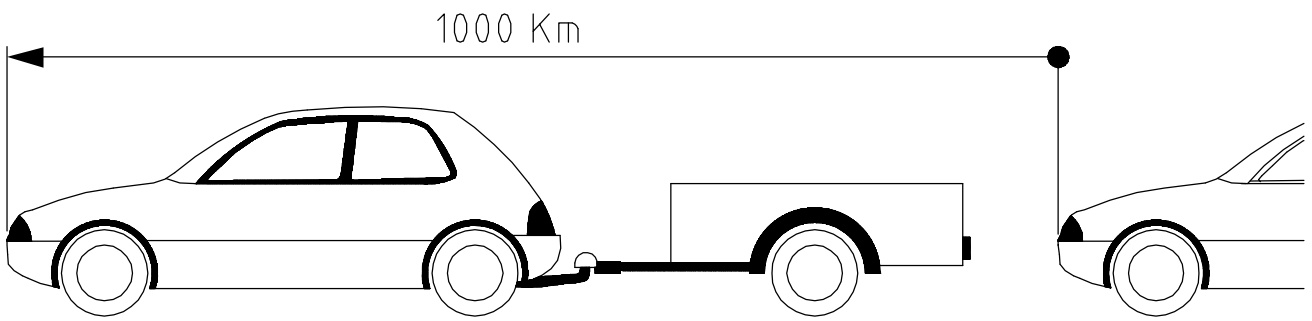
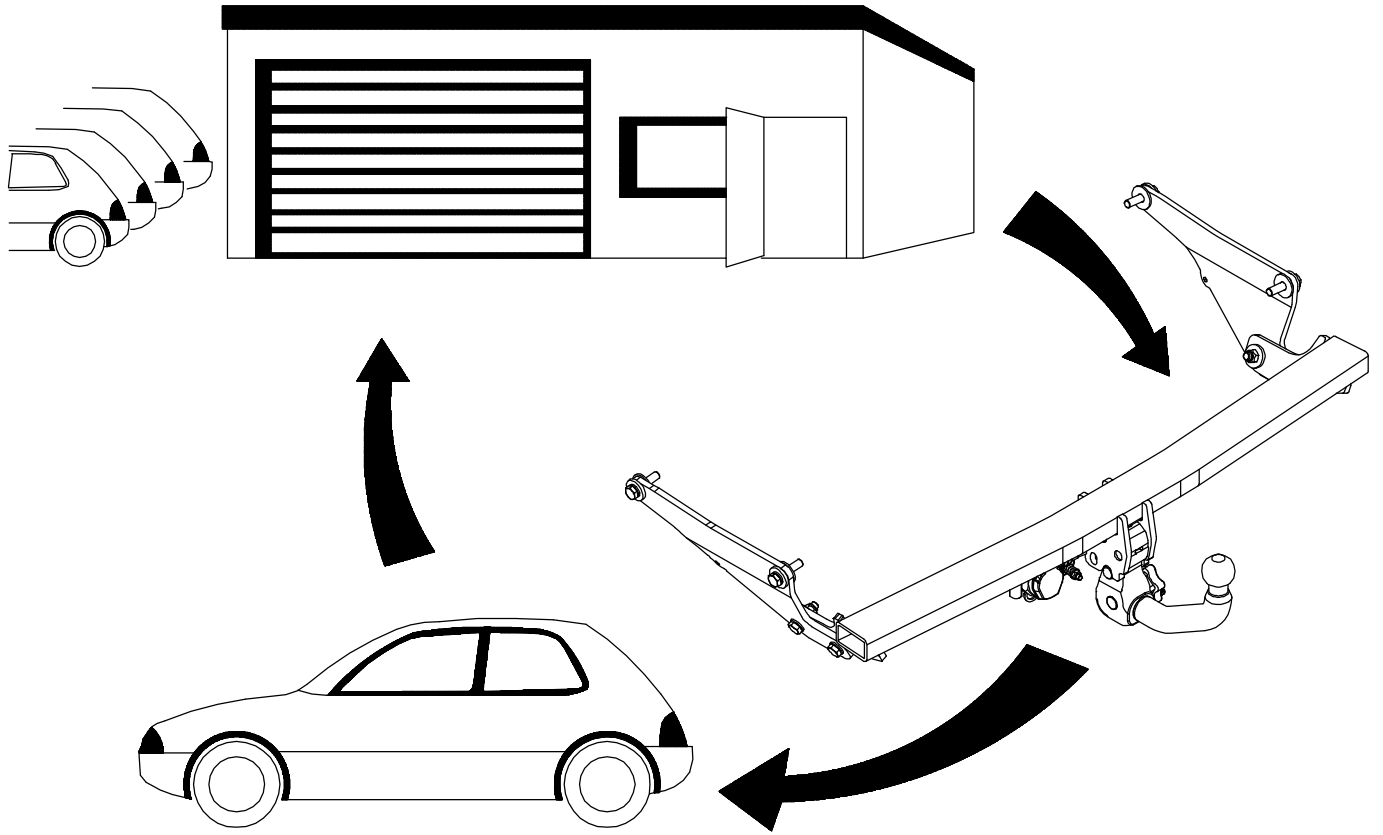

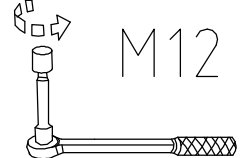

 <p>M12</p>	<p>0 Km</p> 	<p>1000 Km</p> 
---	---	--

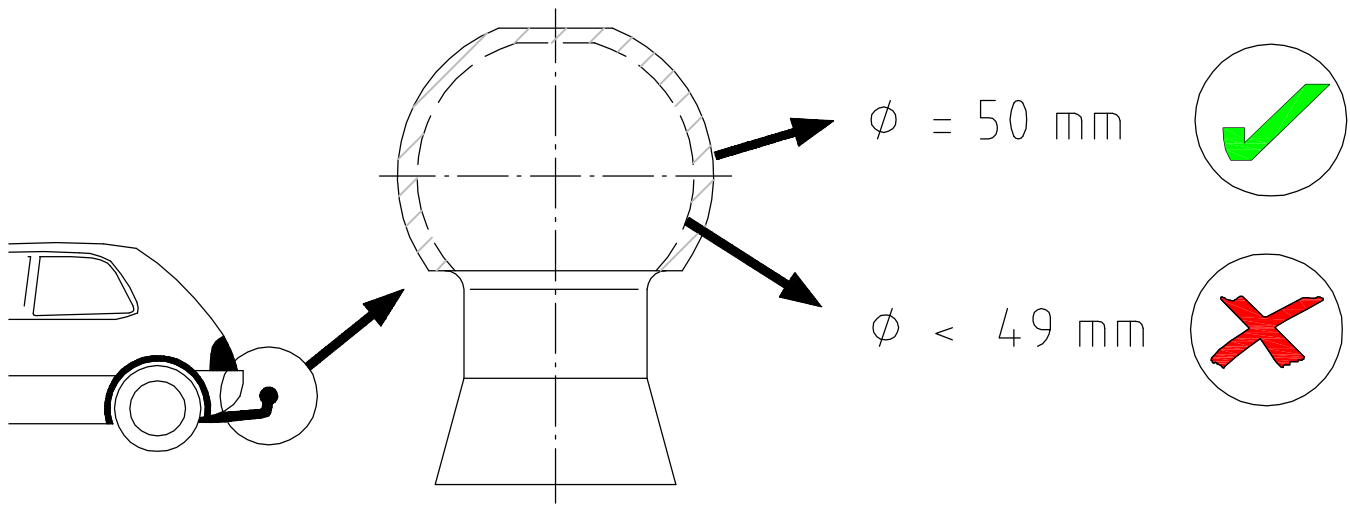

MVG[®]
MVG-Metalverarbeitungsgesellschaft mbH

Approval Number
E4 55R-01 0160









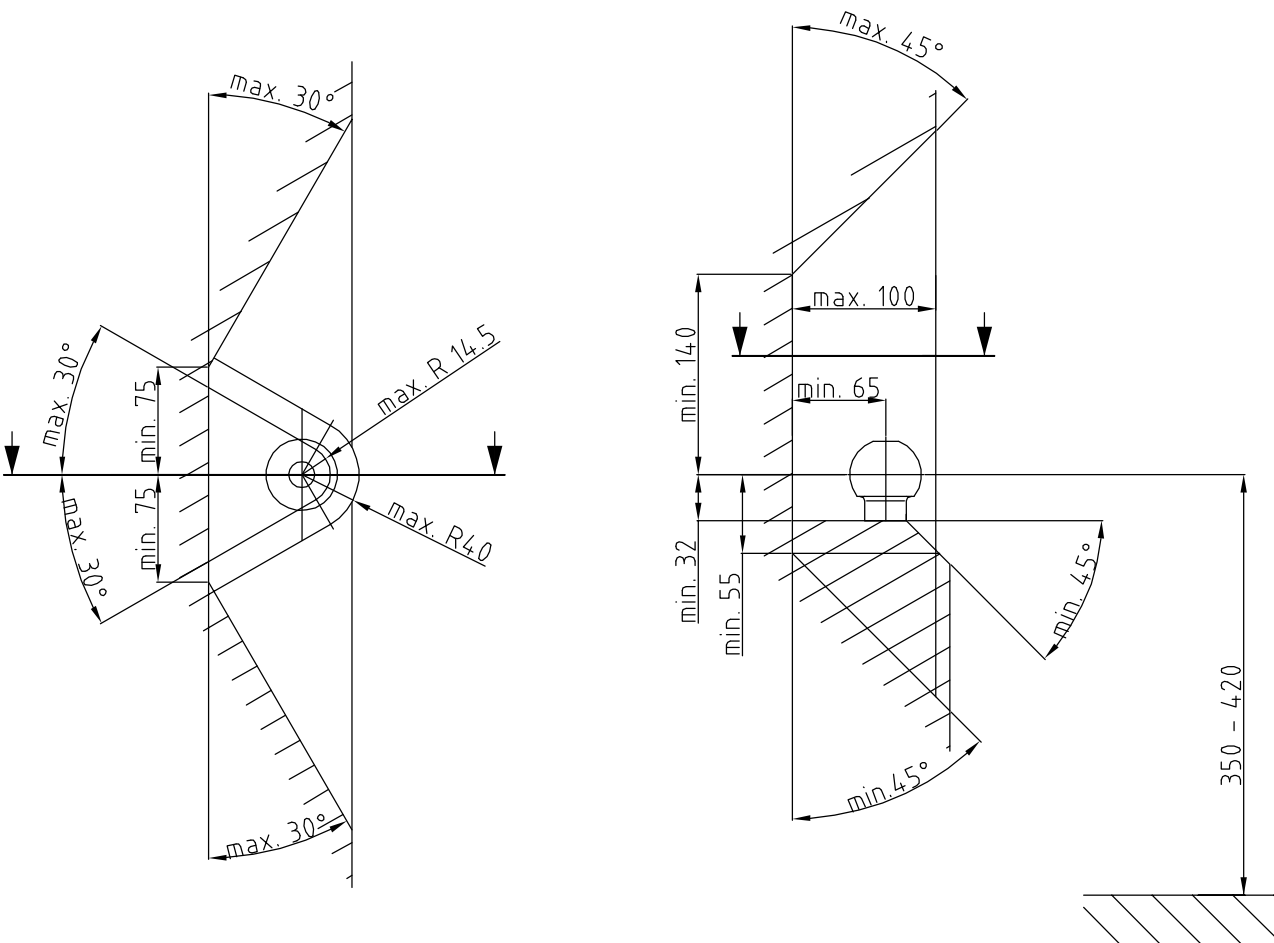

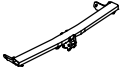



Type: 0595 A D-Value: 11,0 kN
Class: A50-X S-Value: 100 kg











Made in Germany www.mvg-ahk.de

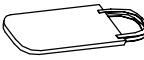

Zulässige Stützlast
maximal 88 kg

MVG[®]
MVG-Metalverarbeitungsgesellschaft mbH
www.mvg-ahk.de



1	1x		0595 A
2	1x		2020-A-5.1
3	je1		
4	4x		M12x <u>1,25</u> x50 (8.8) ISO 8676
5	4x		M12x45 (8.8) ISO 4014
6	4x		∅ 13/29x3 (St.) ISO 7093
7	8x		∅ 13/35x5 (St.) DIN 6340
8	4x		∅ 13/24x2,5 (St.) ISO 7089
9	4x		A 12 (Fst.) DIN 127
10	4x		M12 (8) ISO 7042
11	1x		
12	1x		M8x50 (8.8) ISO 4017
13	1x		∅ 8,4/24x2 (St.) ISO 7093
14	1x		M8 (8) ISO 7042

15	1x		
16	2x		
17	1x		
18	2x		∅ 8,4/16x1.6 DIN 125 PA6.6
19	1x		0595 A
20			System 2020
21	1x		0069
22	1x		1012
23	1x		88 kg. 1016
24	2x		
25	1x		

26	2x		
27	2x		M12x50 (8.8) ISO 4014

- (E)** Volumen de suministro del enganche
- (D)** Lieferumfang der Anhängervorrichtung
- (GB)** Scope of delivery of towing hitch
- (F)** Pièces comprises dans la fourniture de l'attelage

- (NL)** Leveringsomvang trekhaak
- (S)** Dragkrokens leveransspecifikation
- (CZ)** Objem dodání tažného zařízení
- (I)** Dotazione del gancio di traino

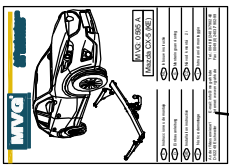
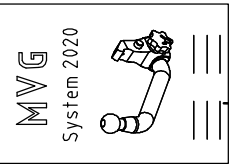
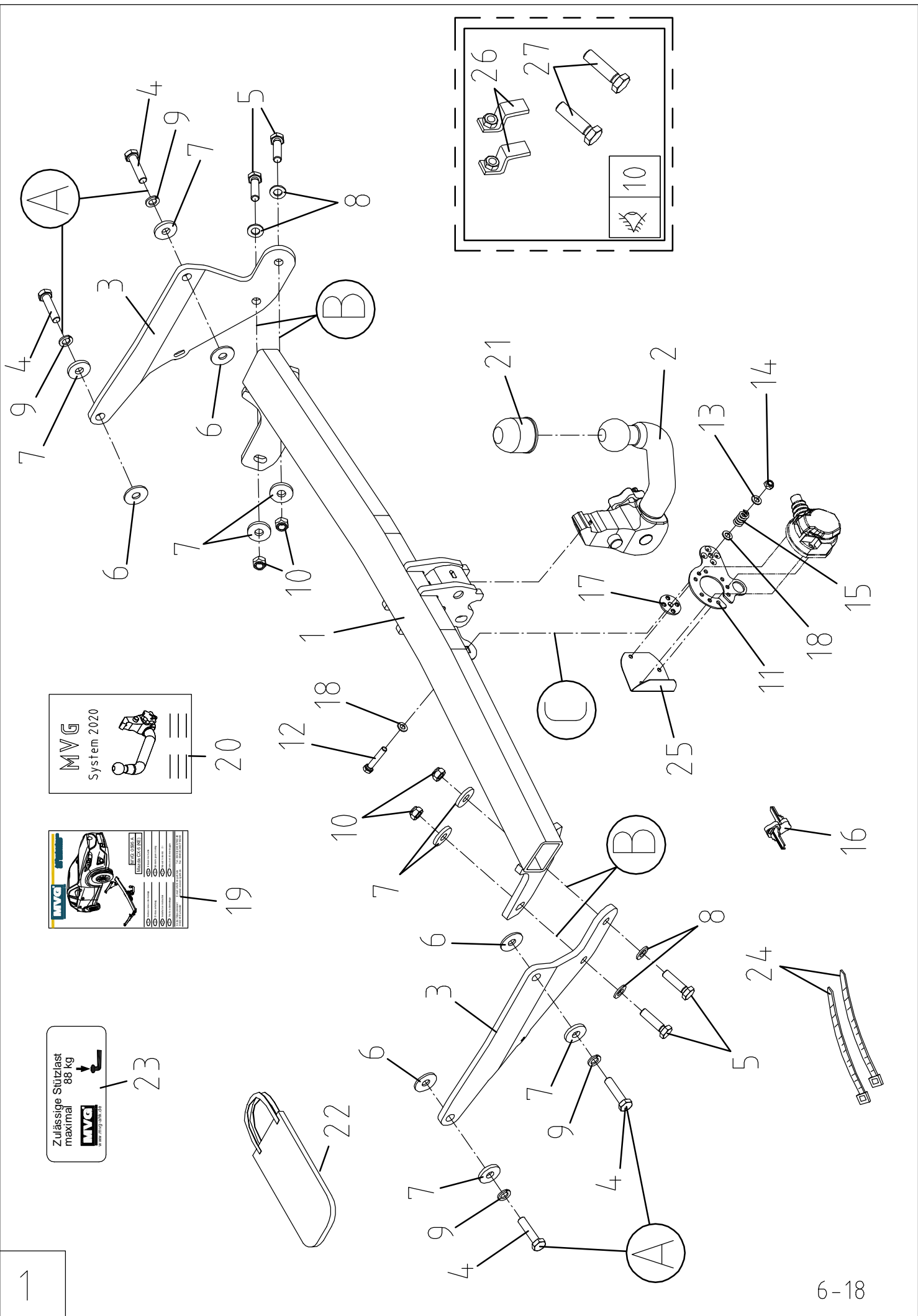

Zulässige Stützlast
maximal
88 kg

MVG
www.mvg.de

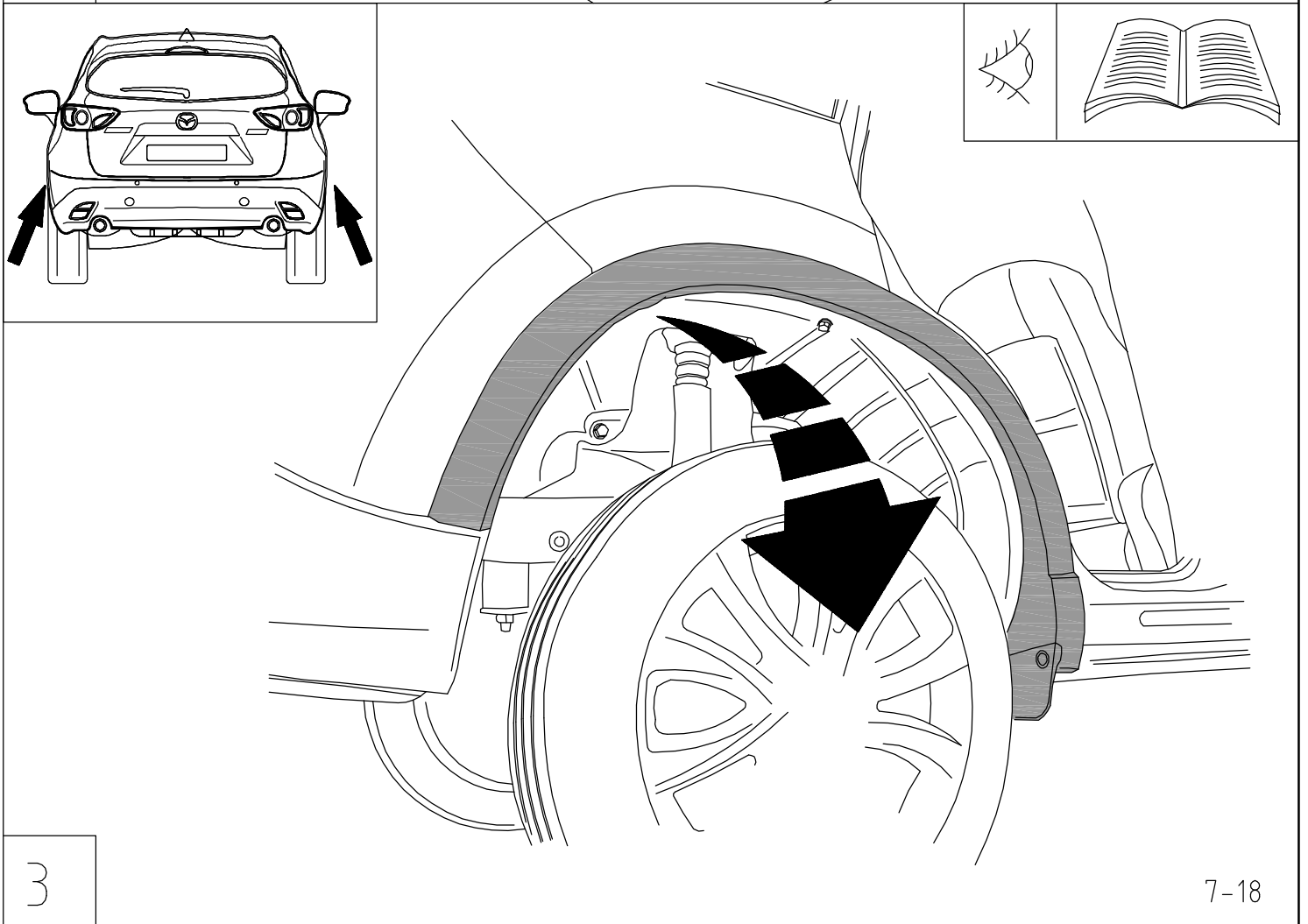
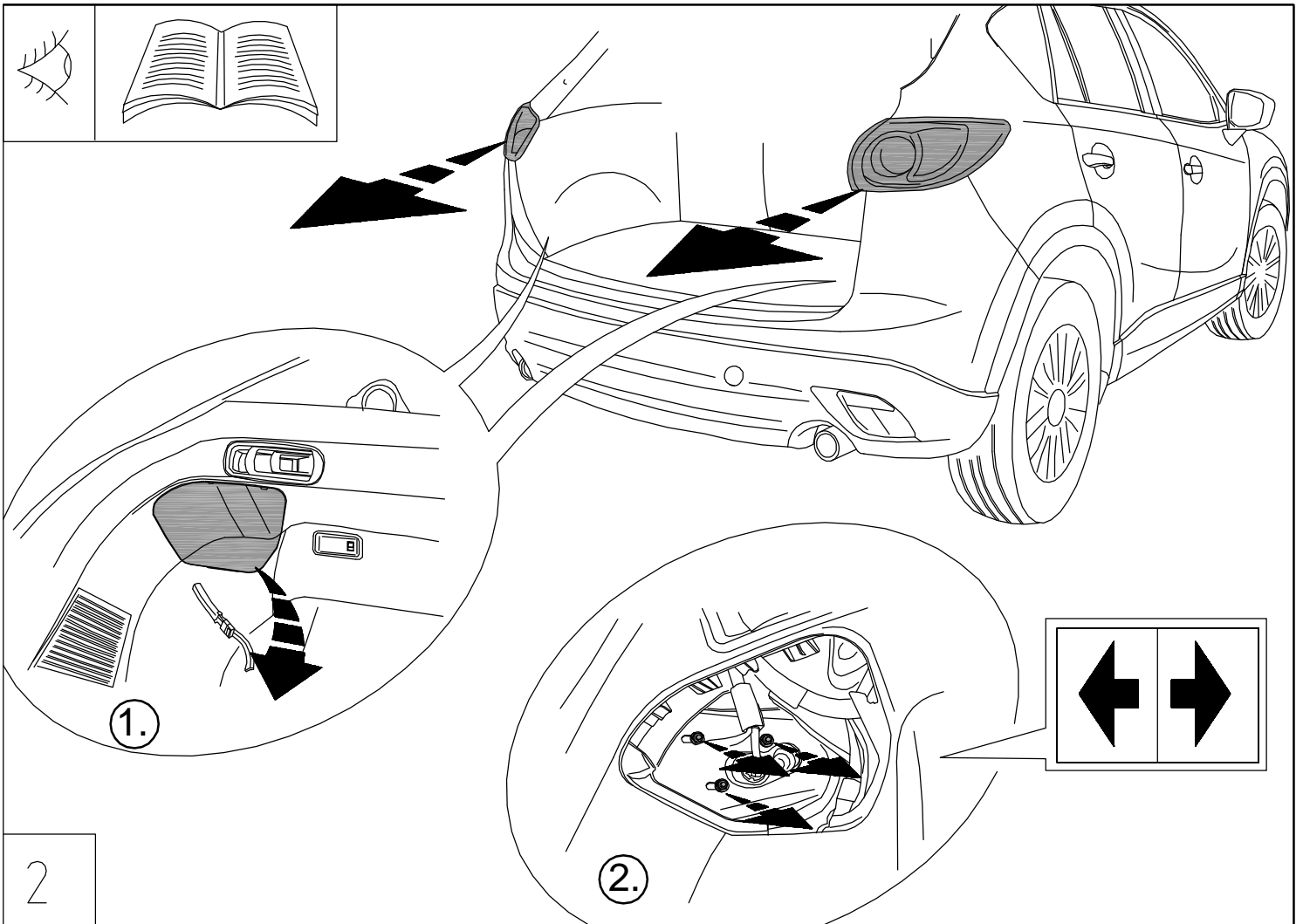

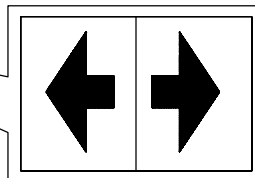
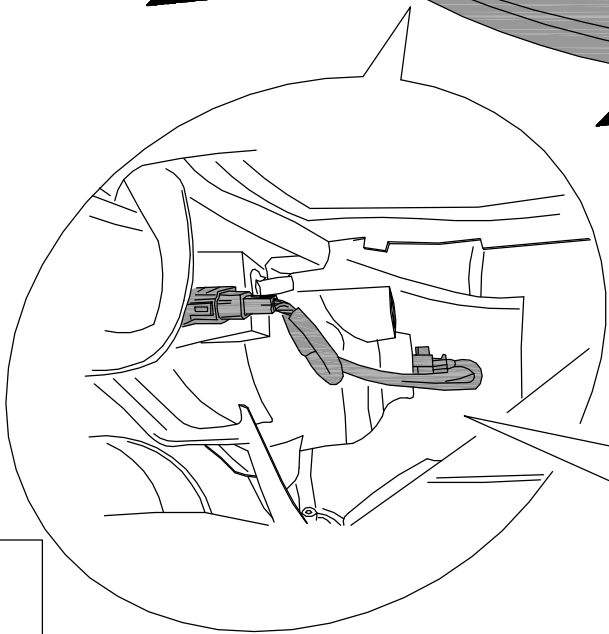
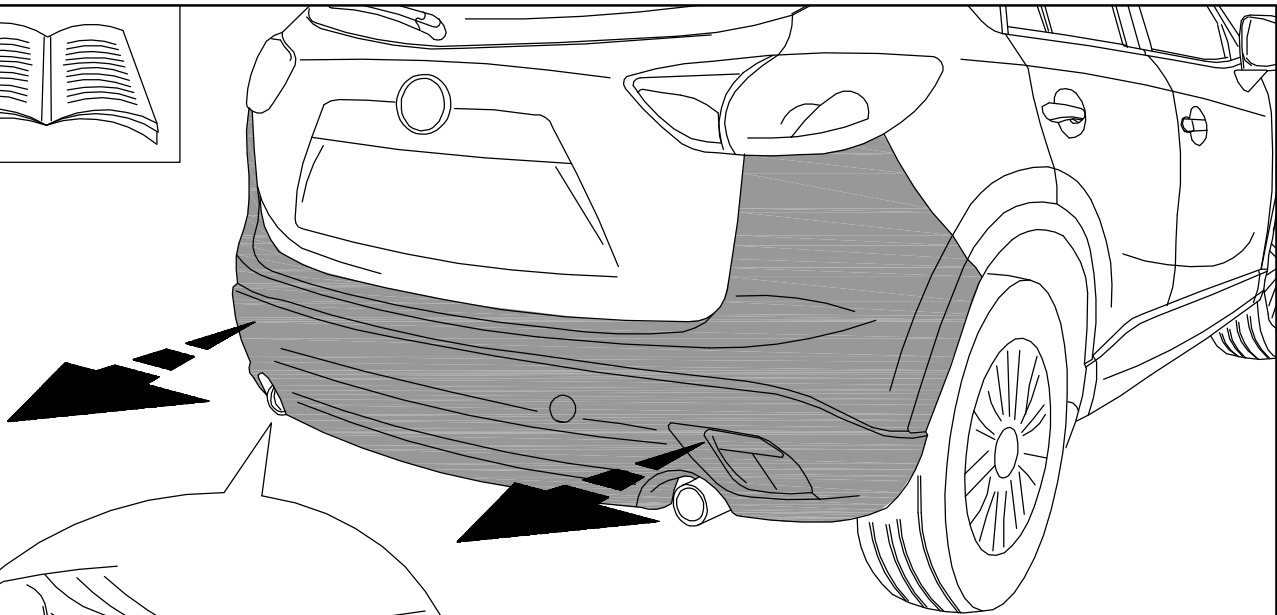
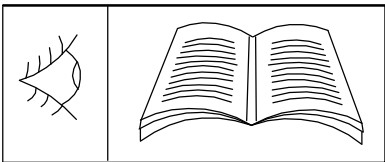

4

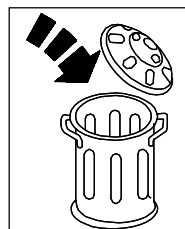
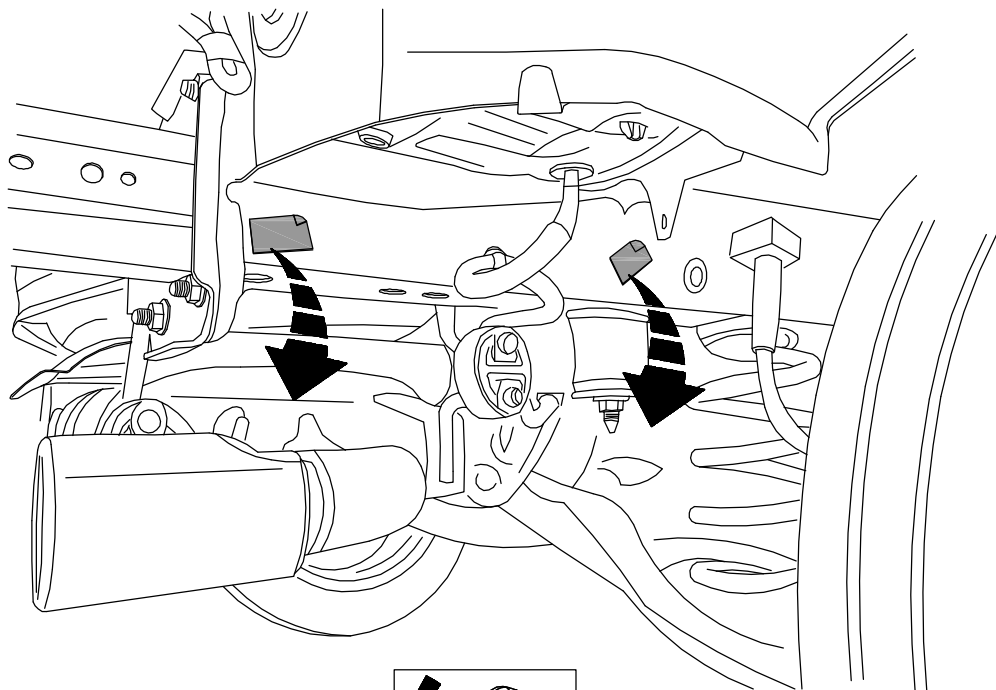
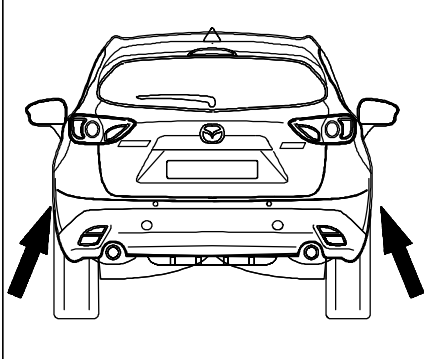

5

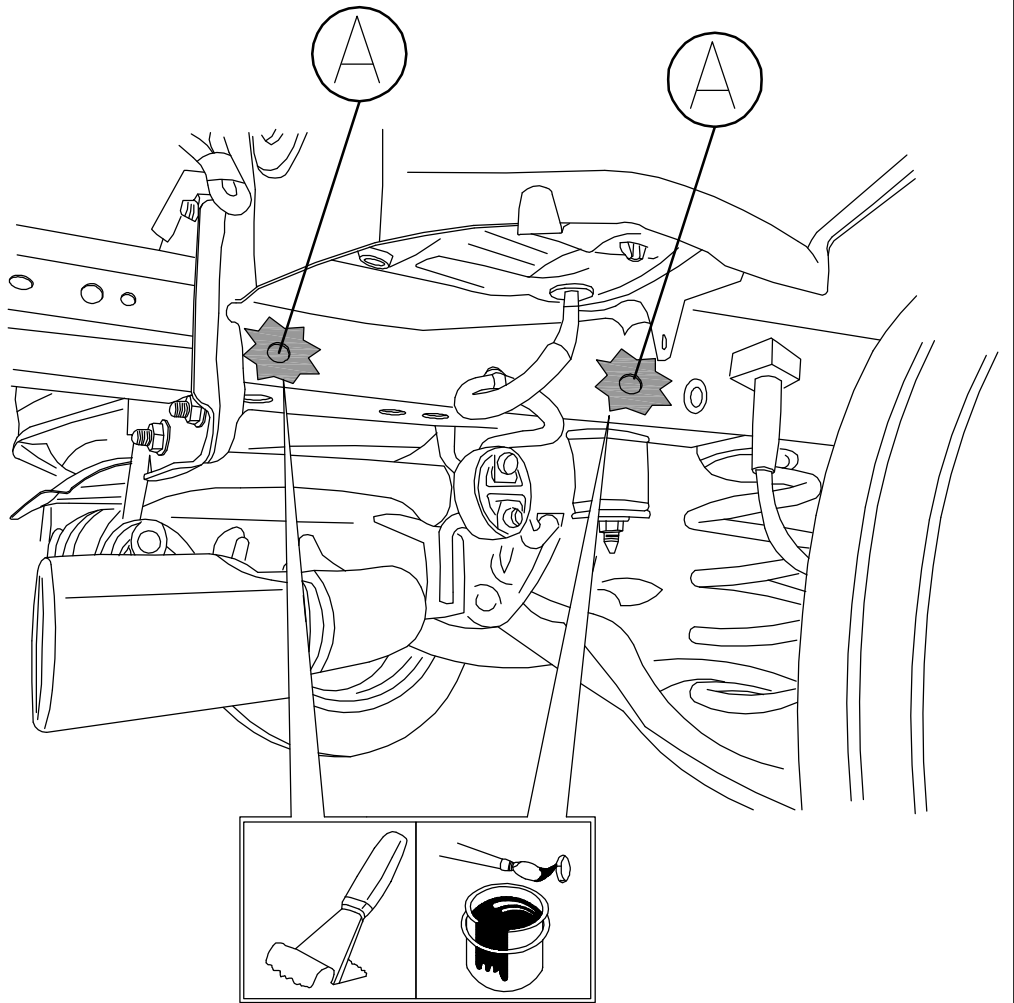
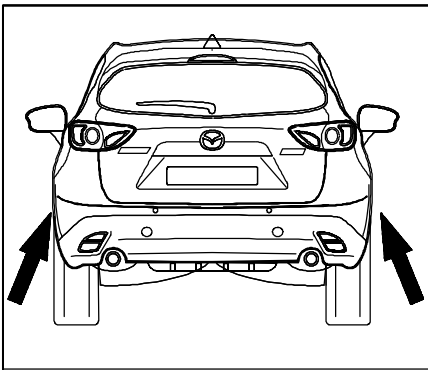

6

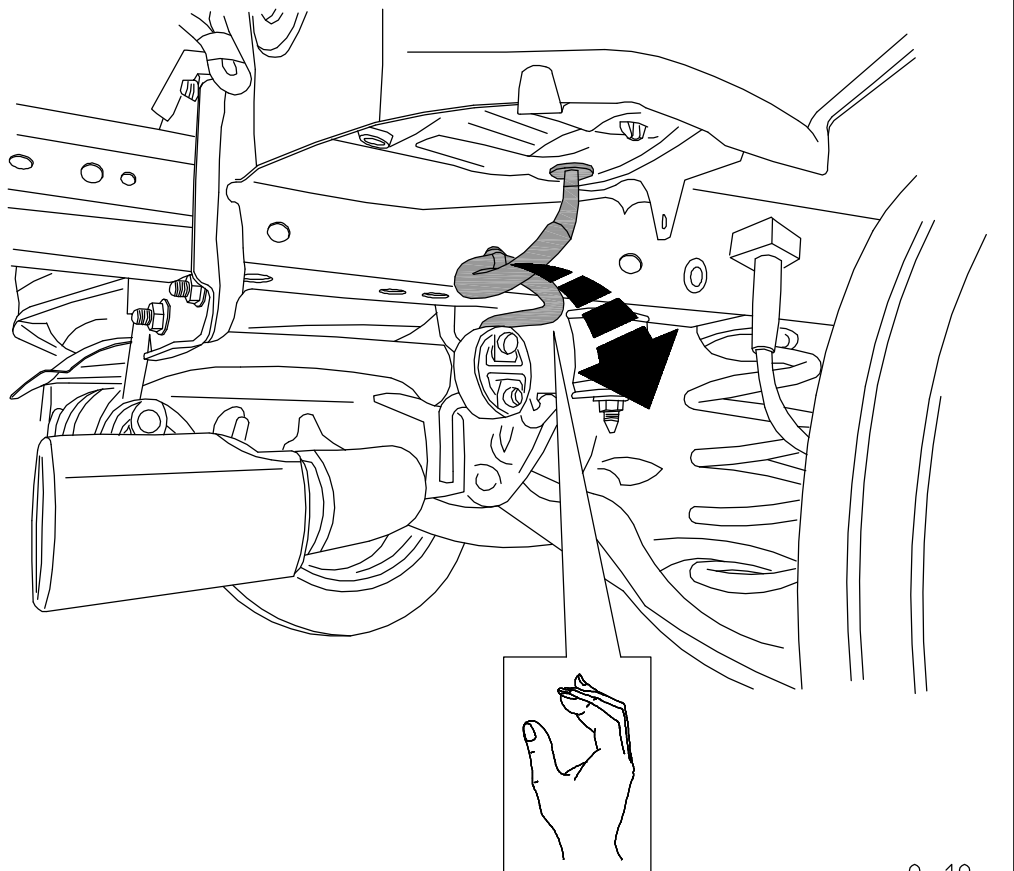
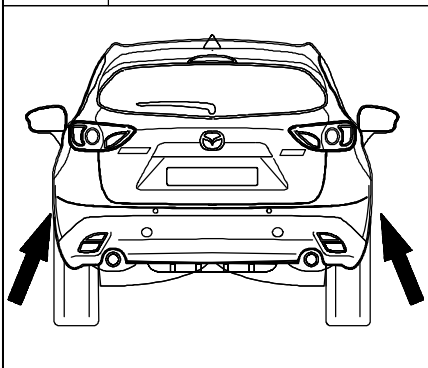

7

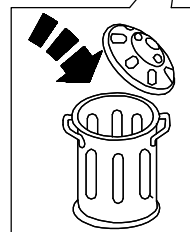
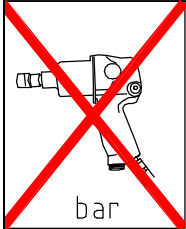
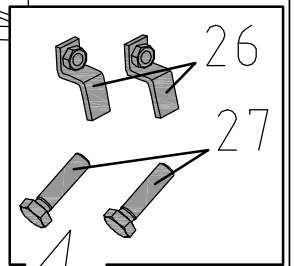
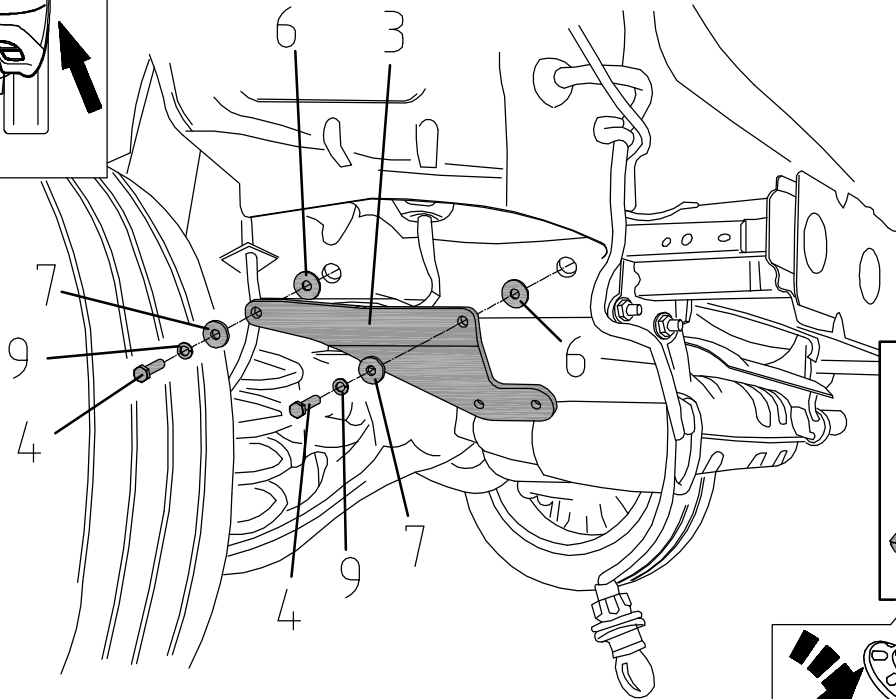
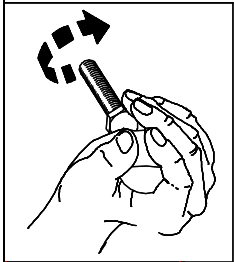
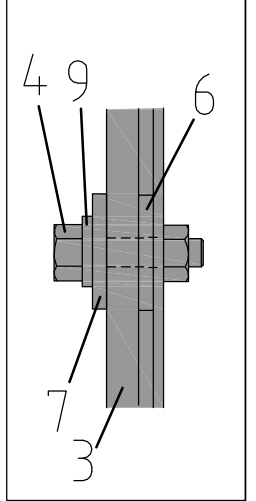
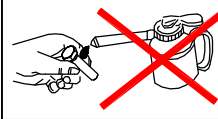
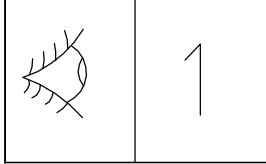
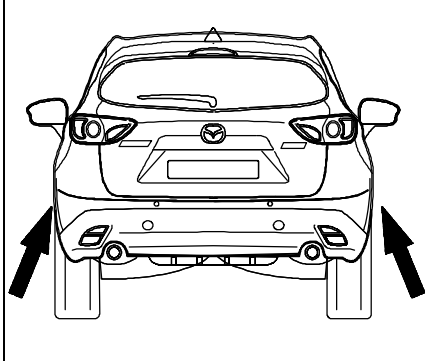
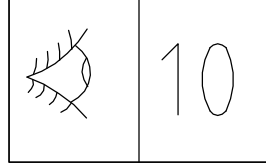
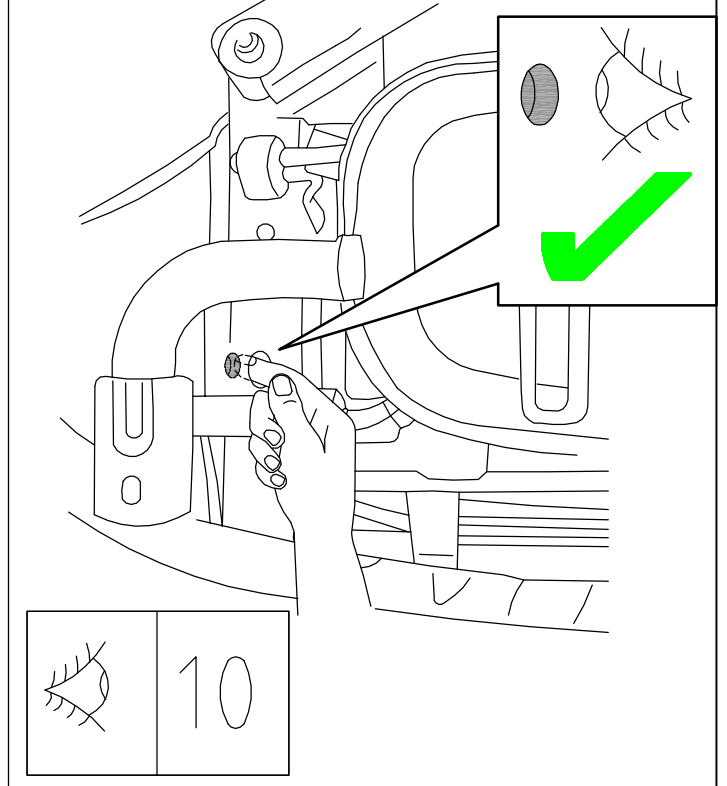
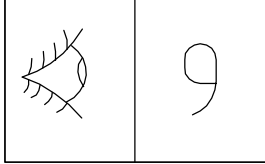
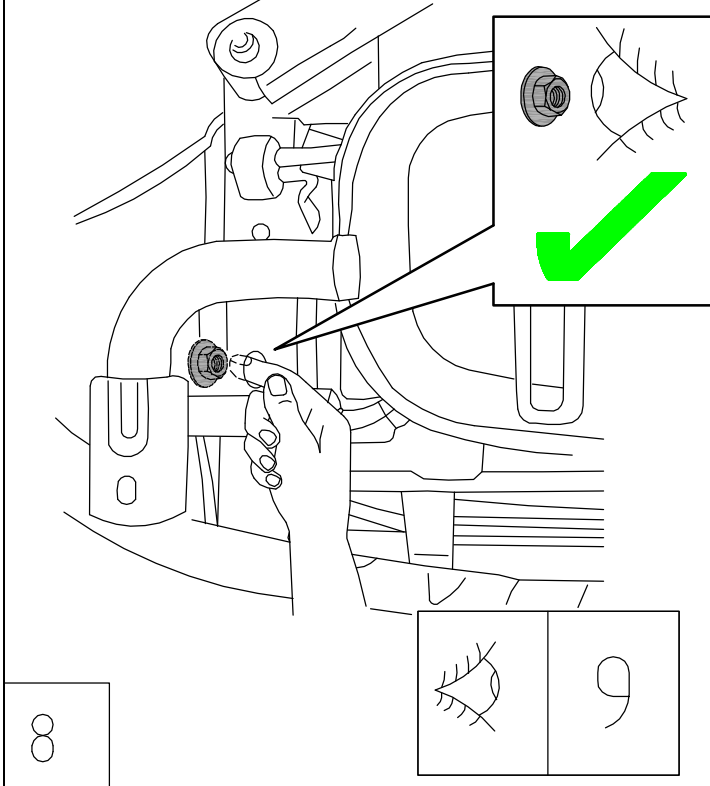
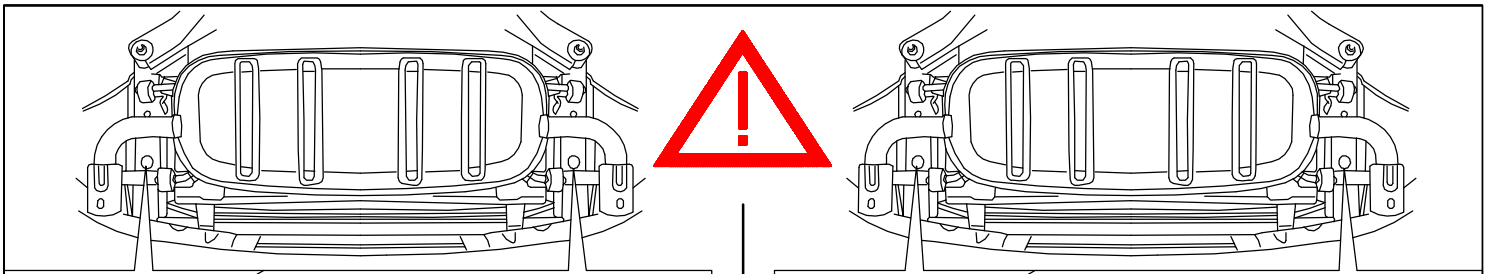

9

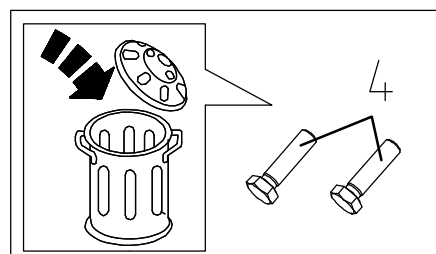
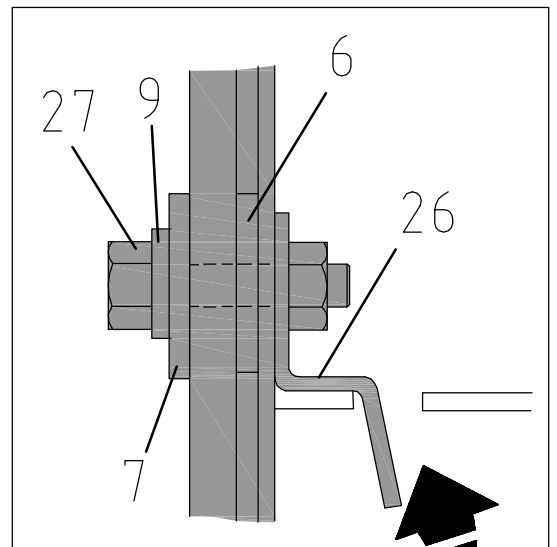
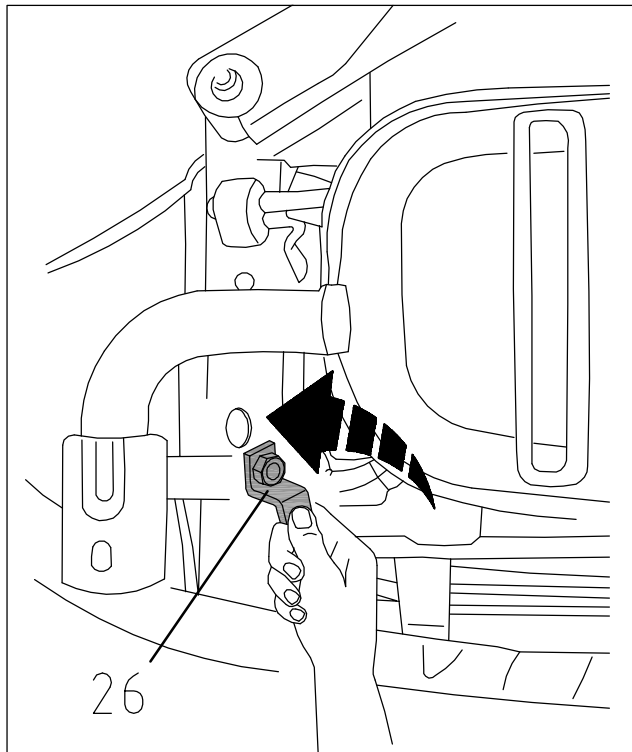
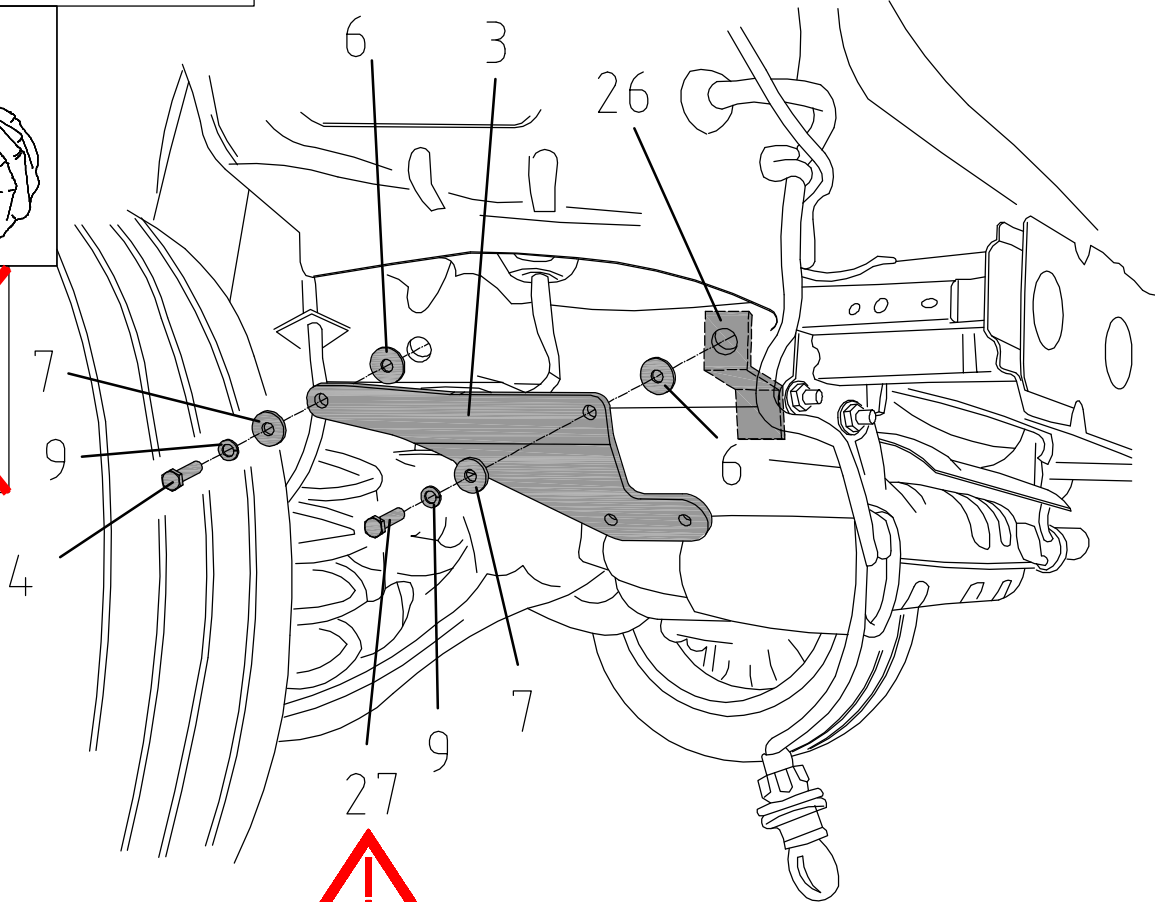
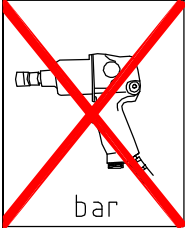
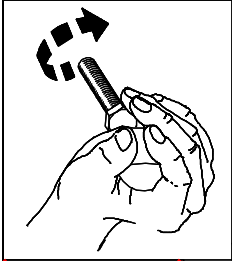
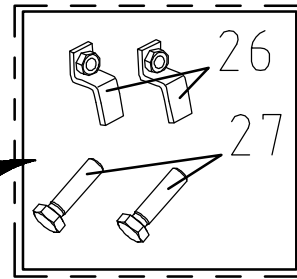
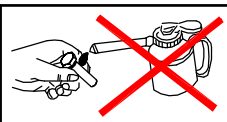
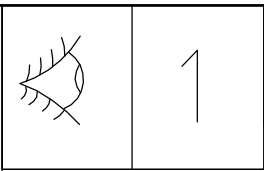
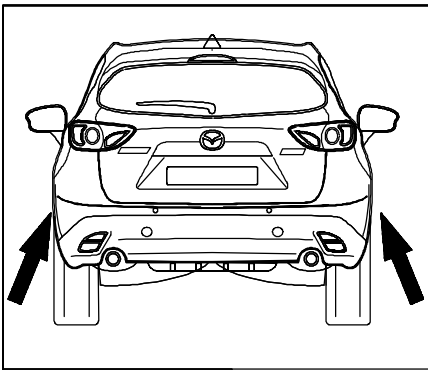

10

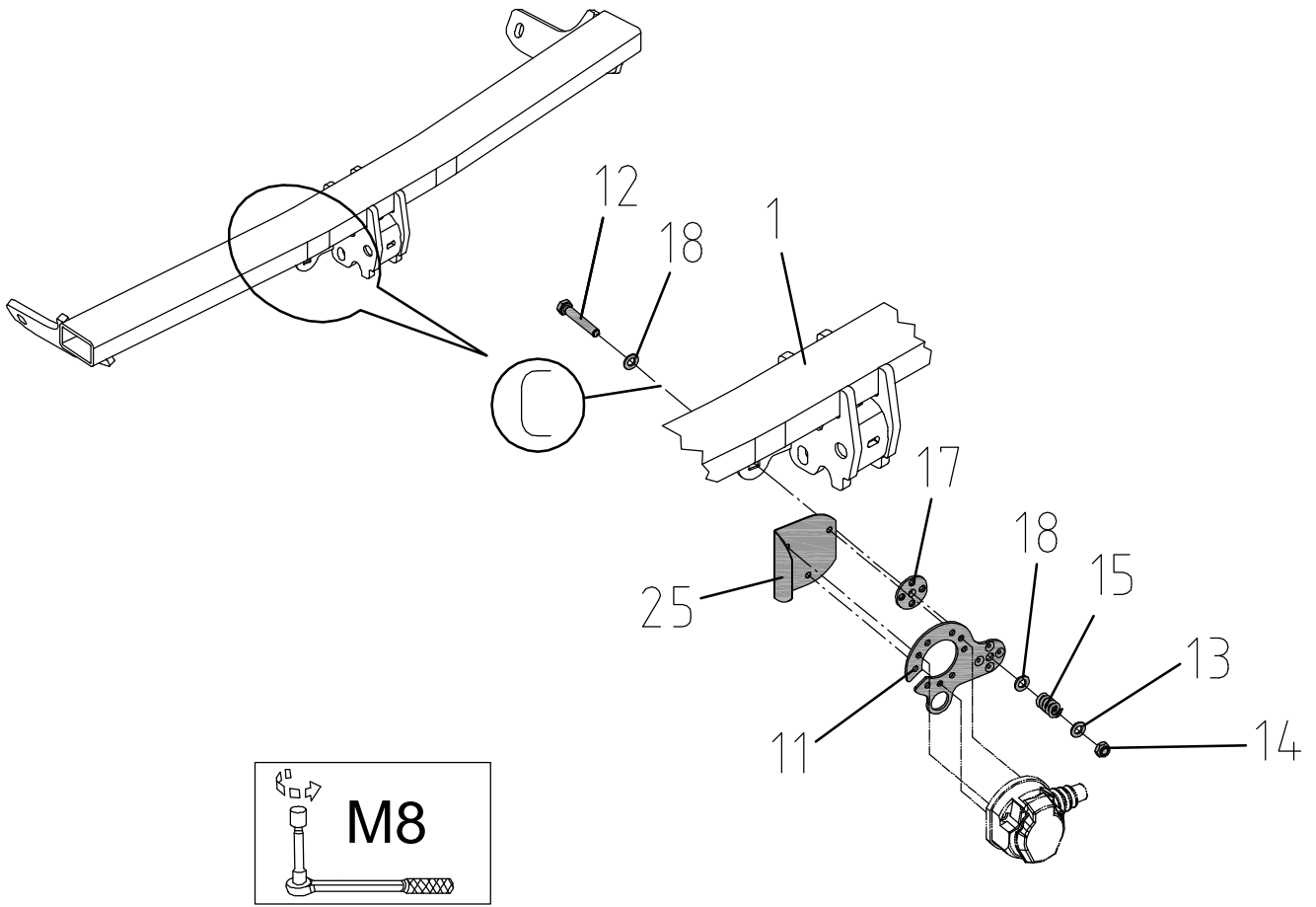

11

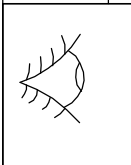

1

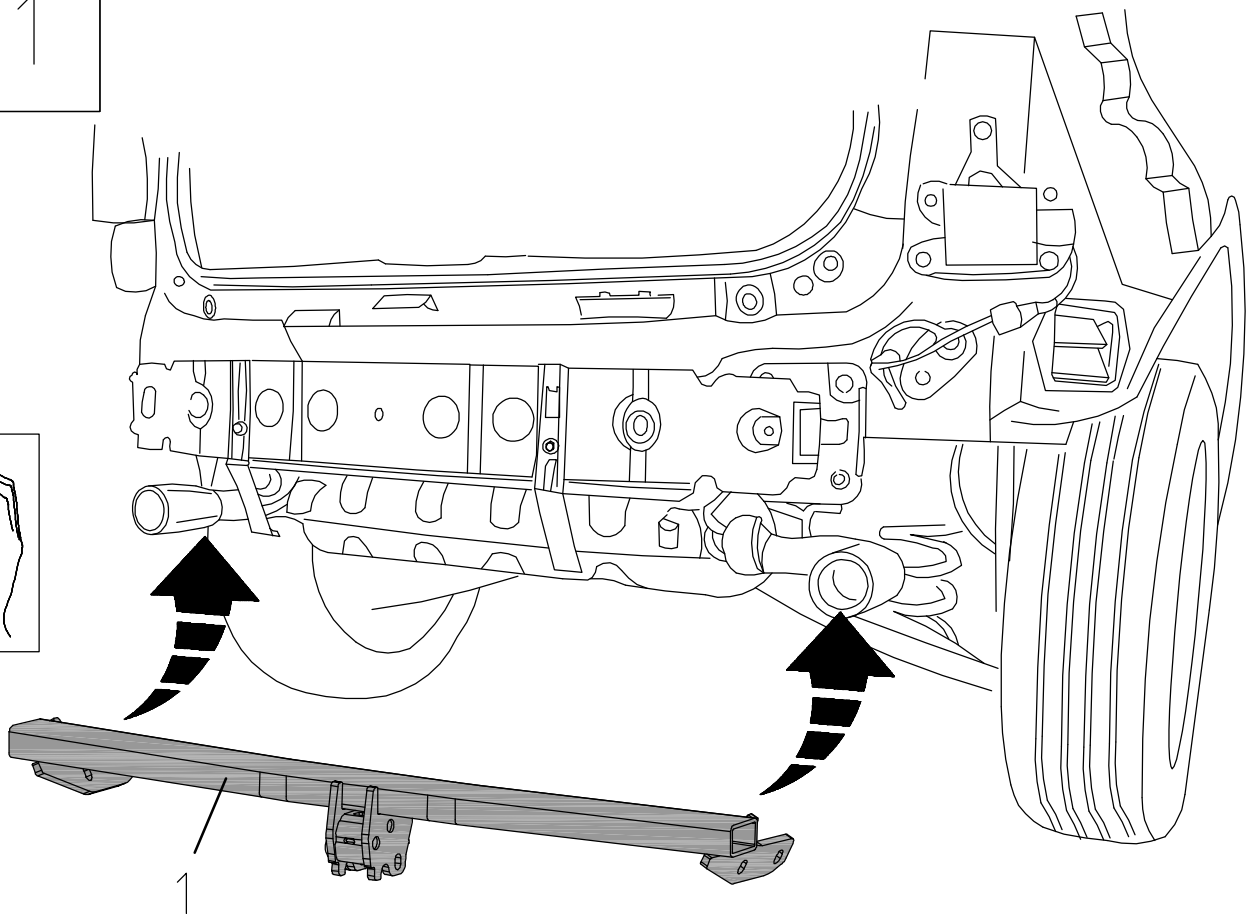
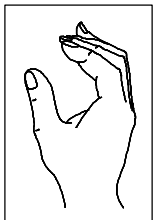

12



1

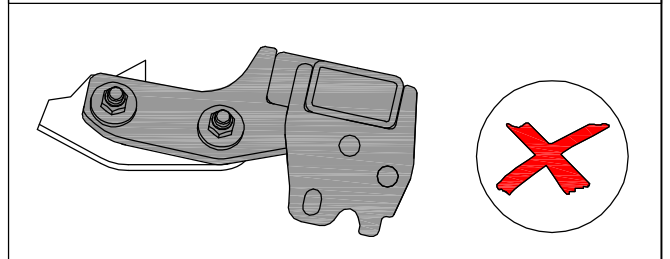
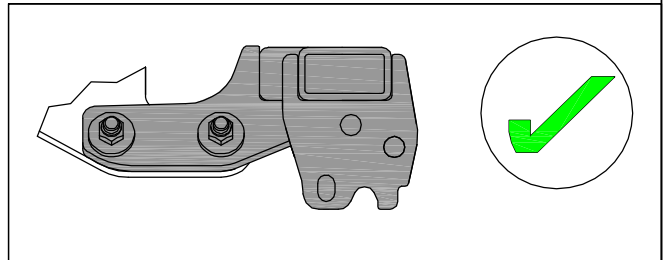
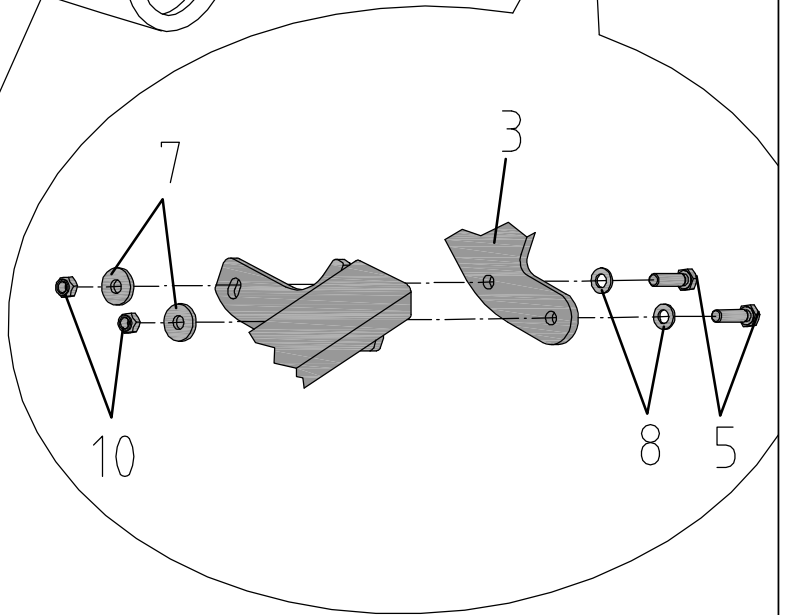
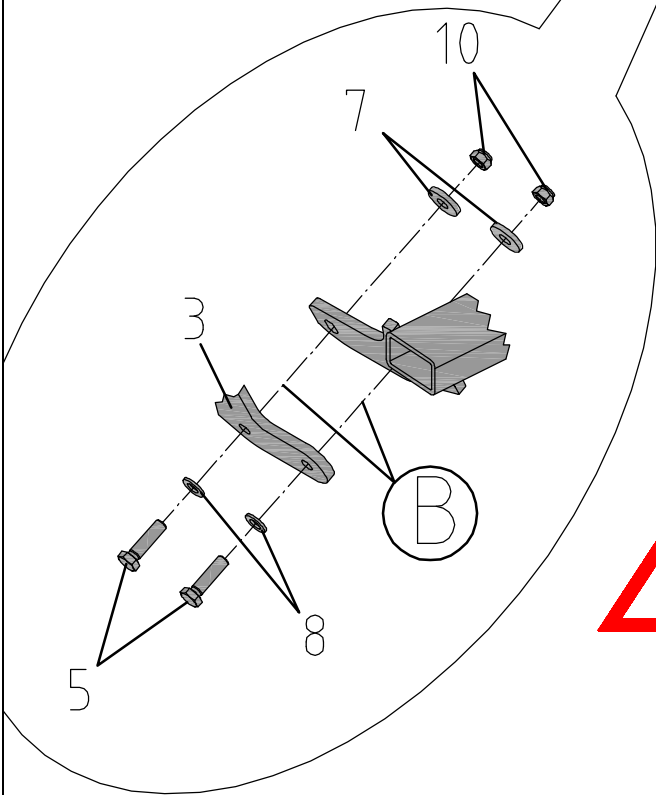
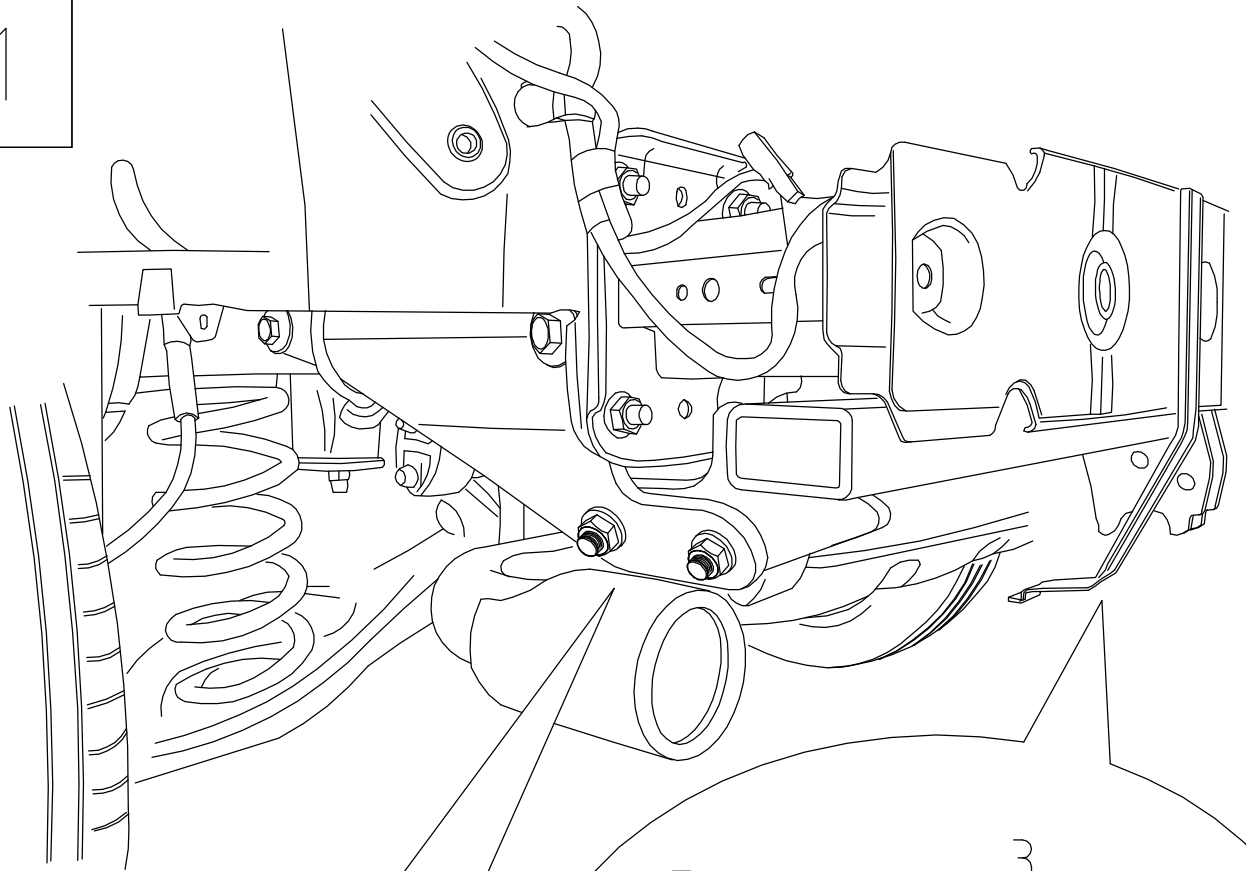

13

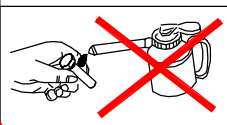
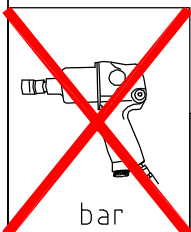
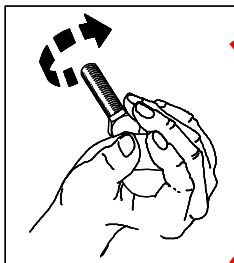

13-18

1

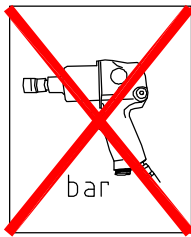
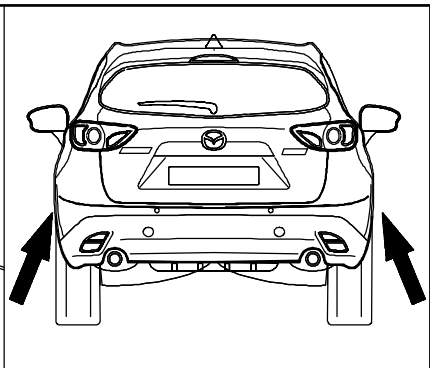
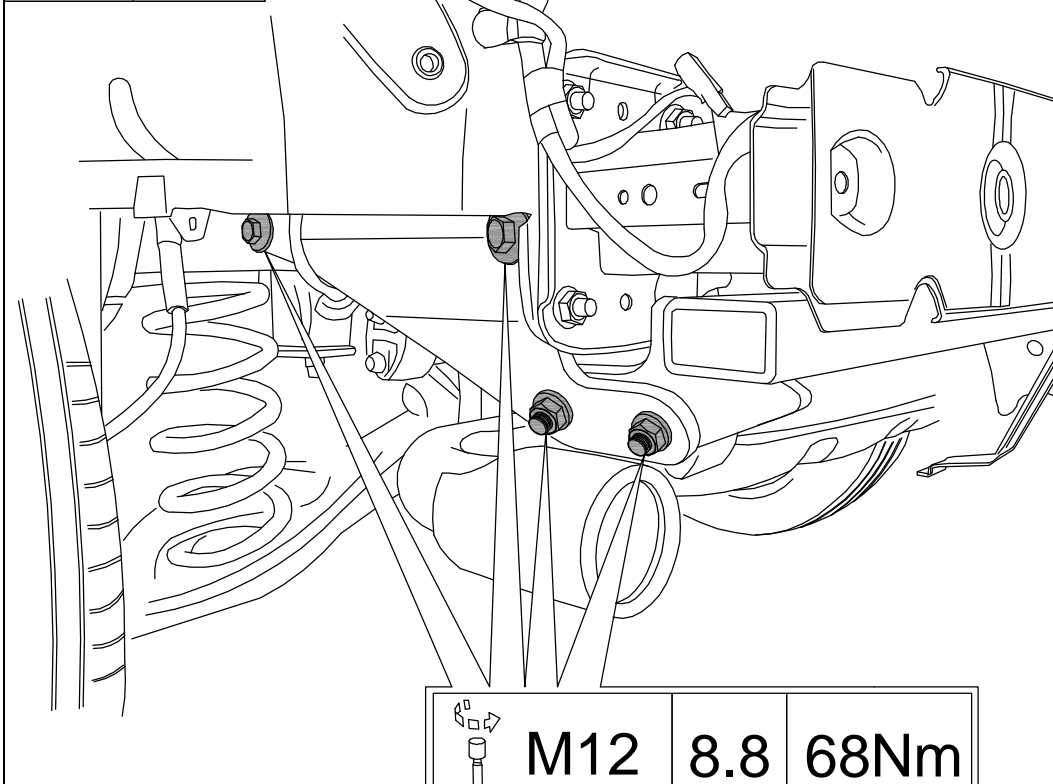

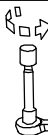
	M12	8.8	68Nm
--	------------	------------	-------------

14

1

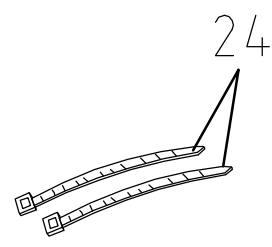
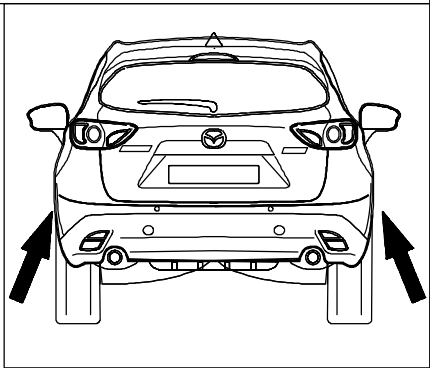
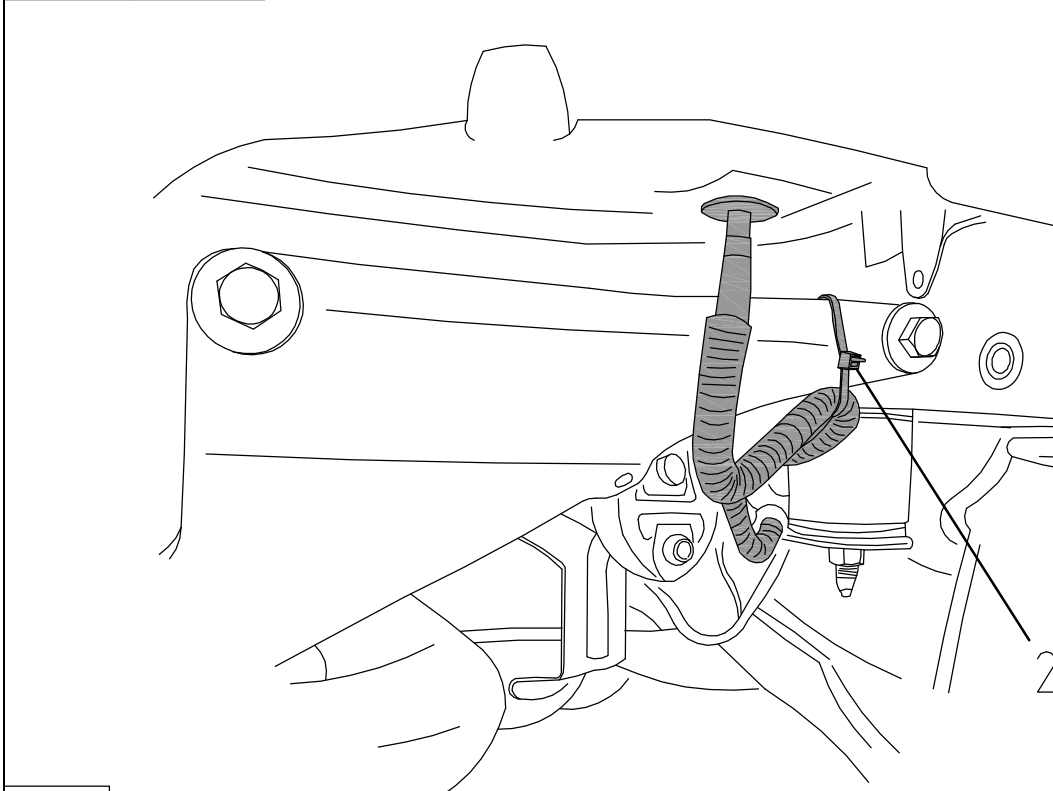

15

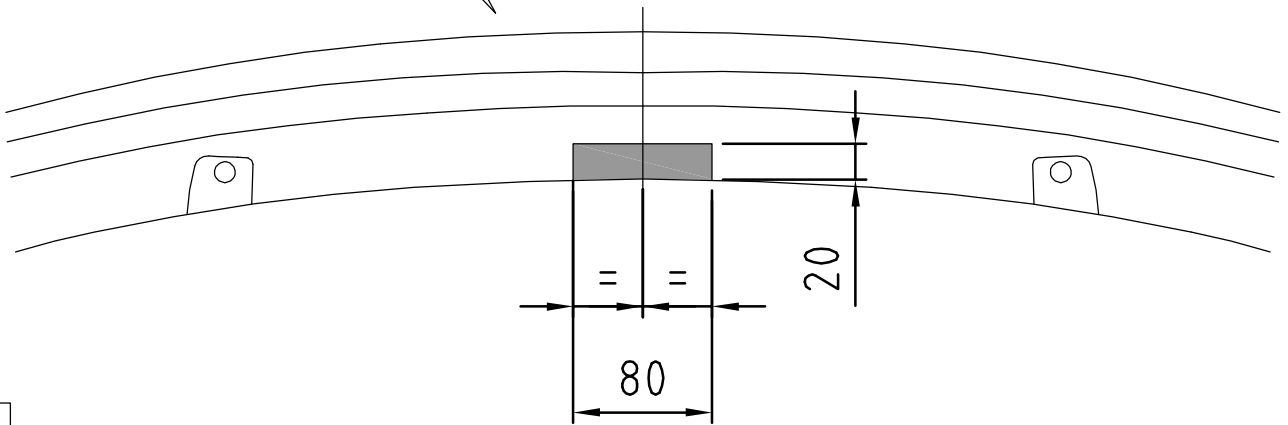
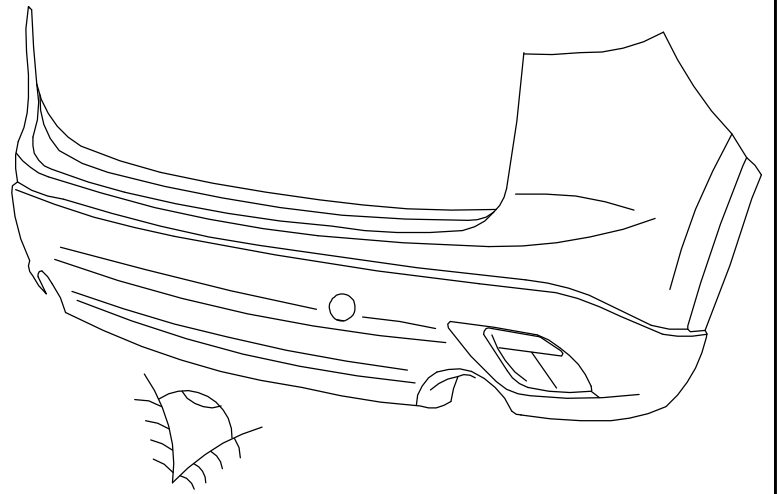
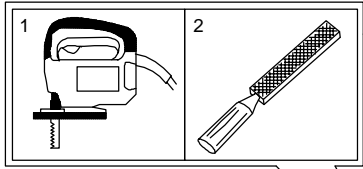

16

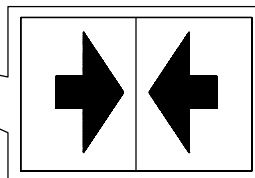
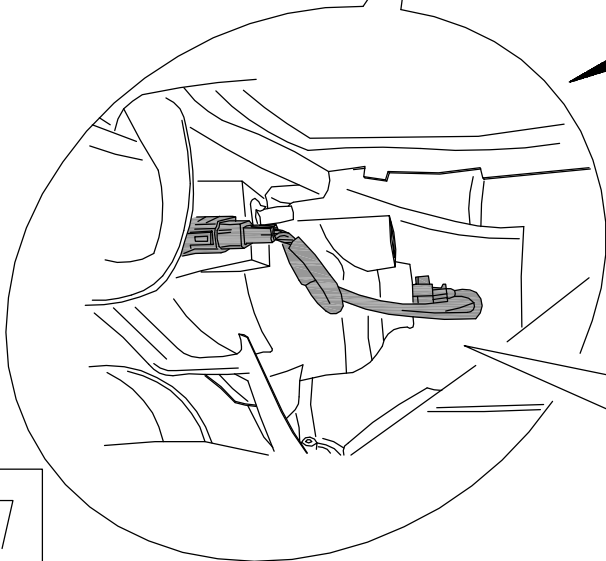
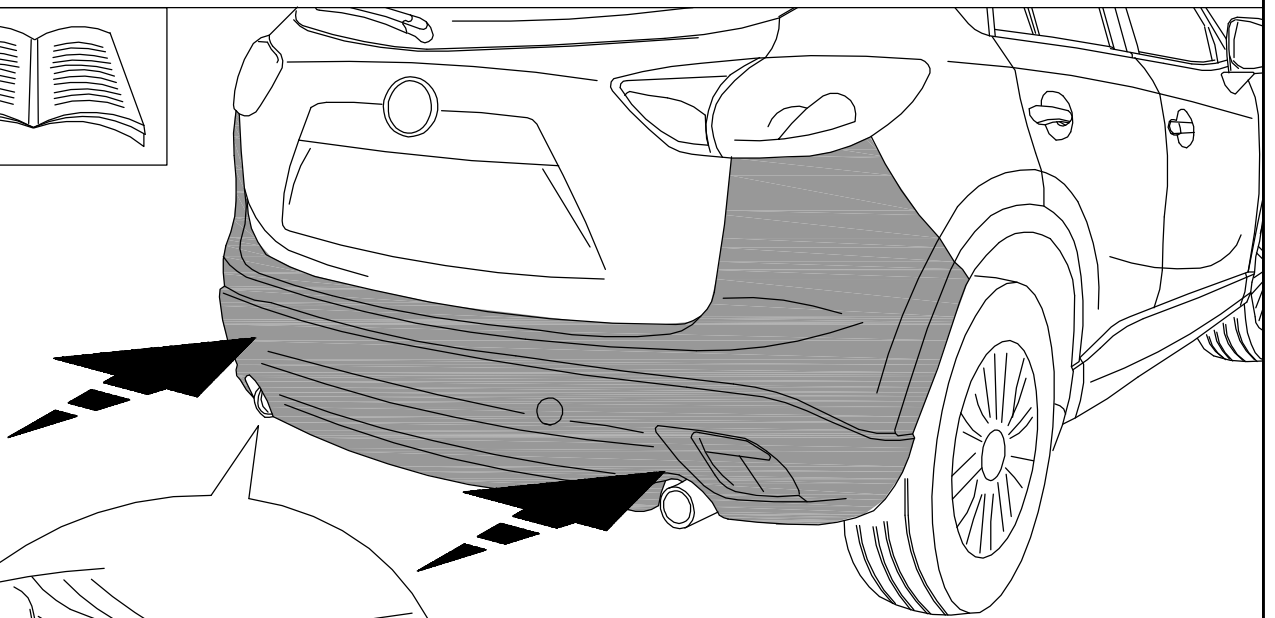
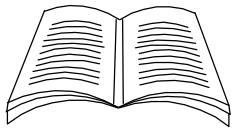

17

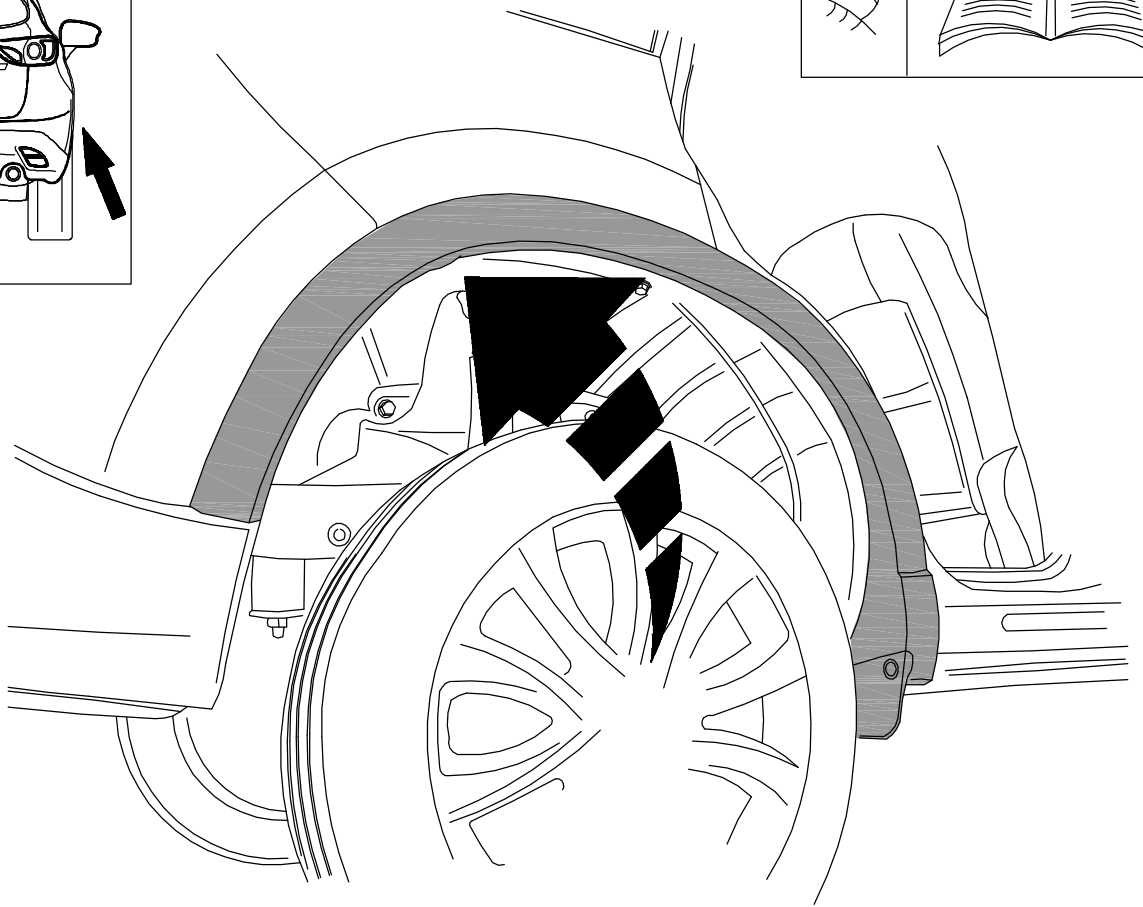
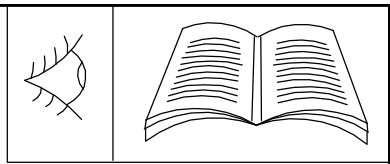
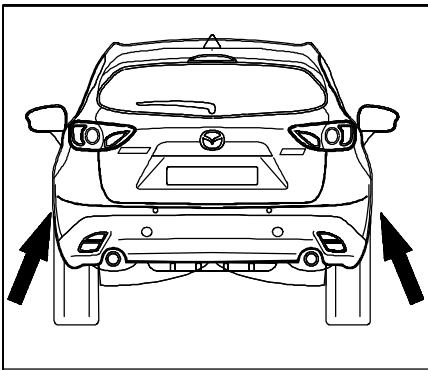

18

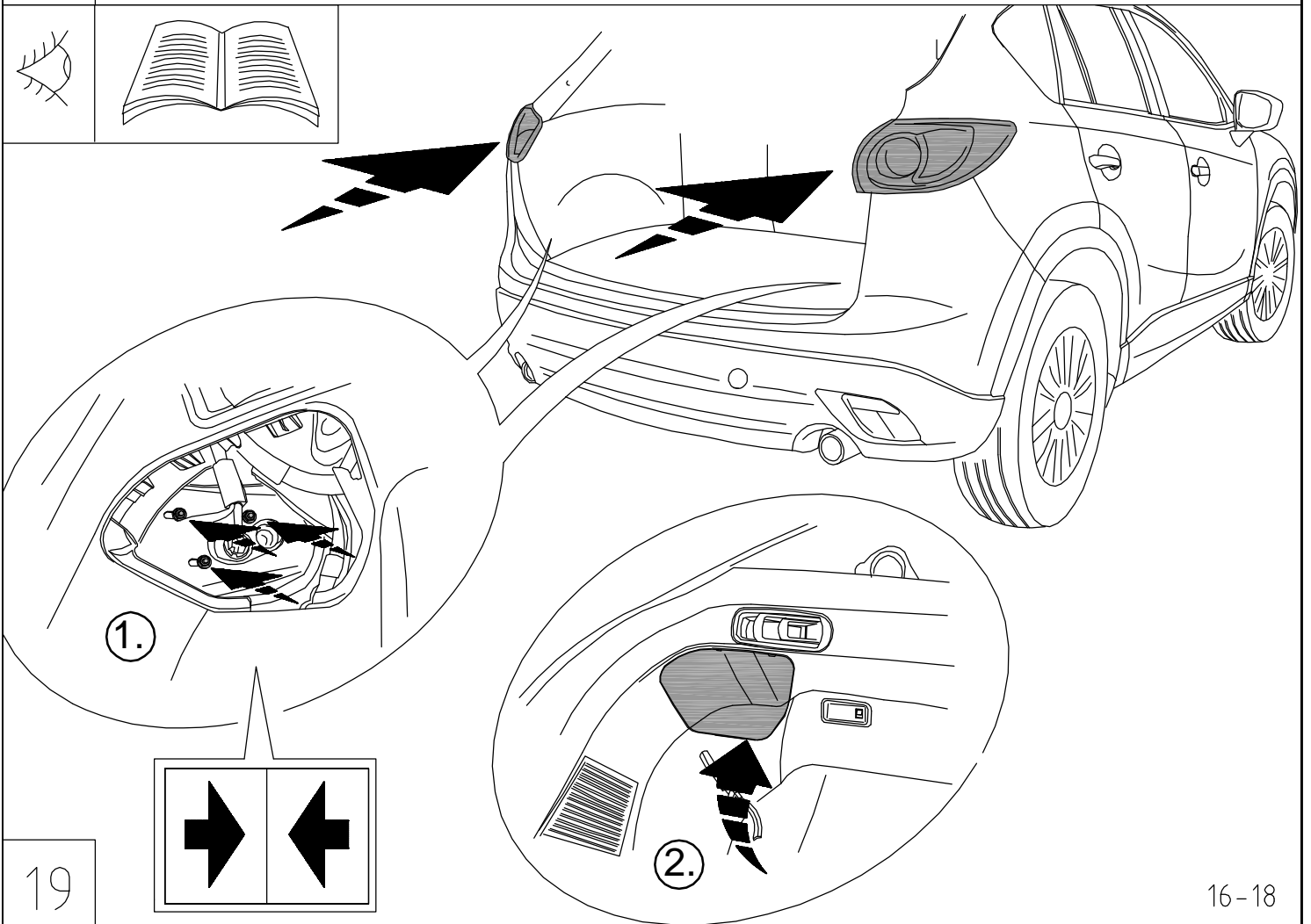
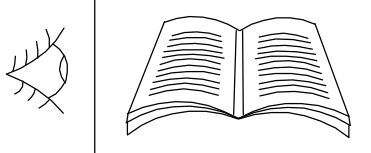

19

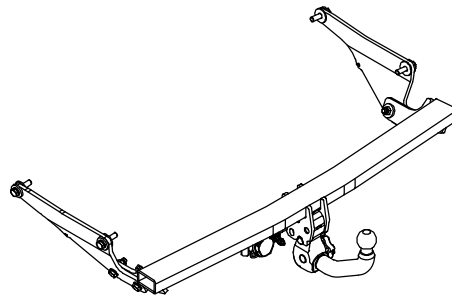
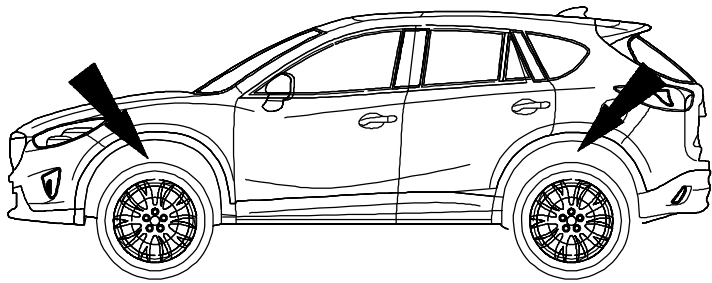

Best. Nr.: 0595 A

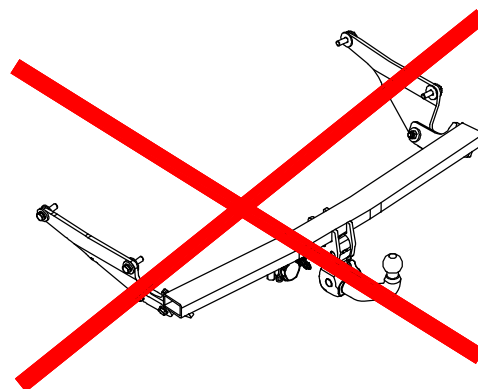
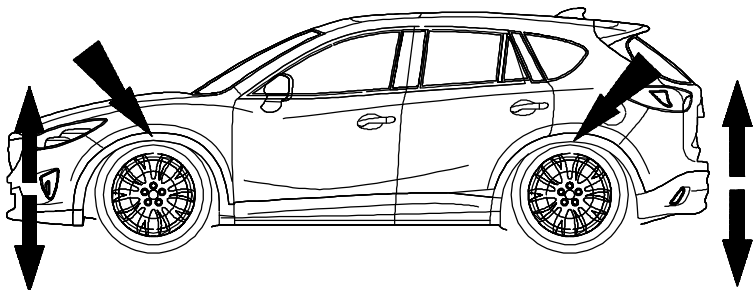

20

Technische Änderungen vorbehalten

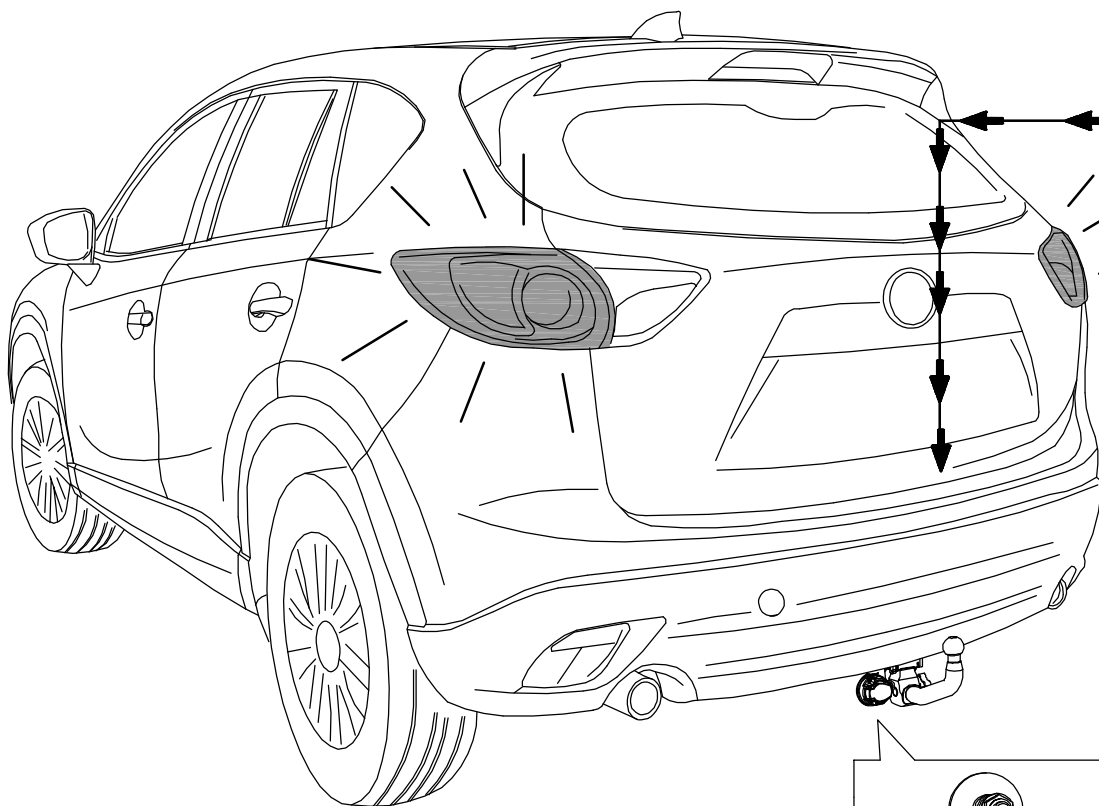

Zulässige Stützlast maximal 88 kg

MVG
www.mvg-ahk.de

23

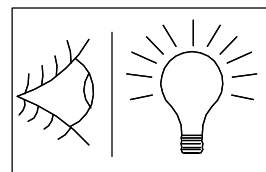

21

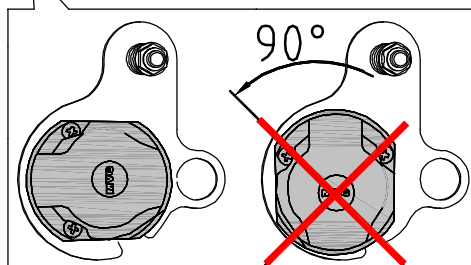

17-18

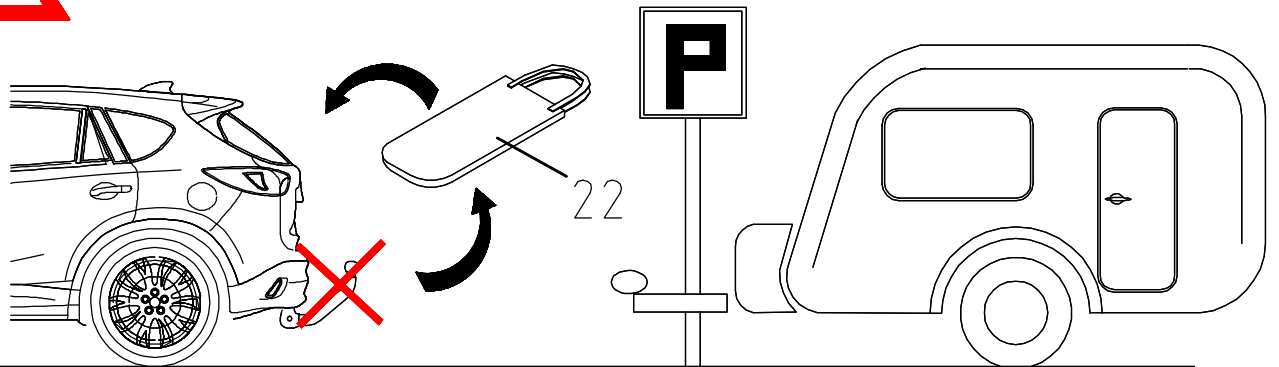
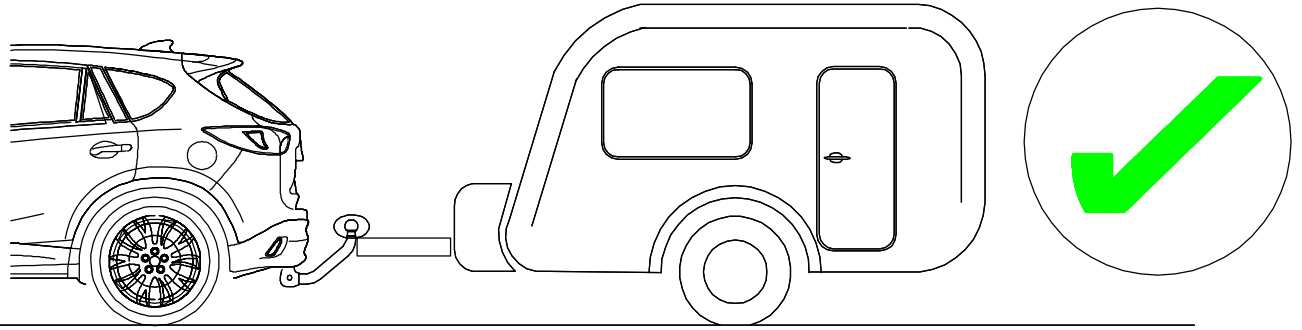

22

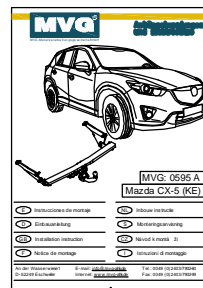
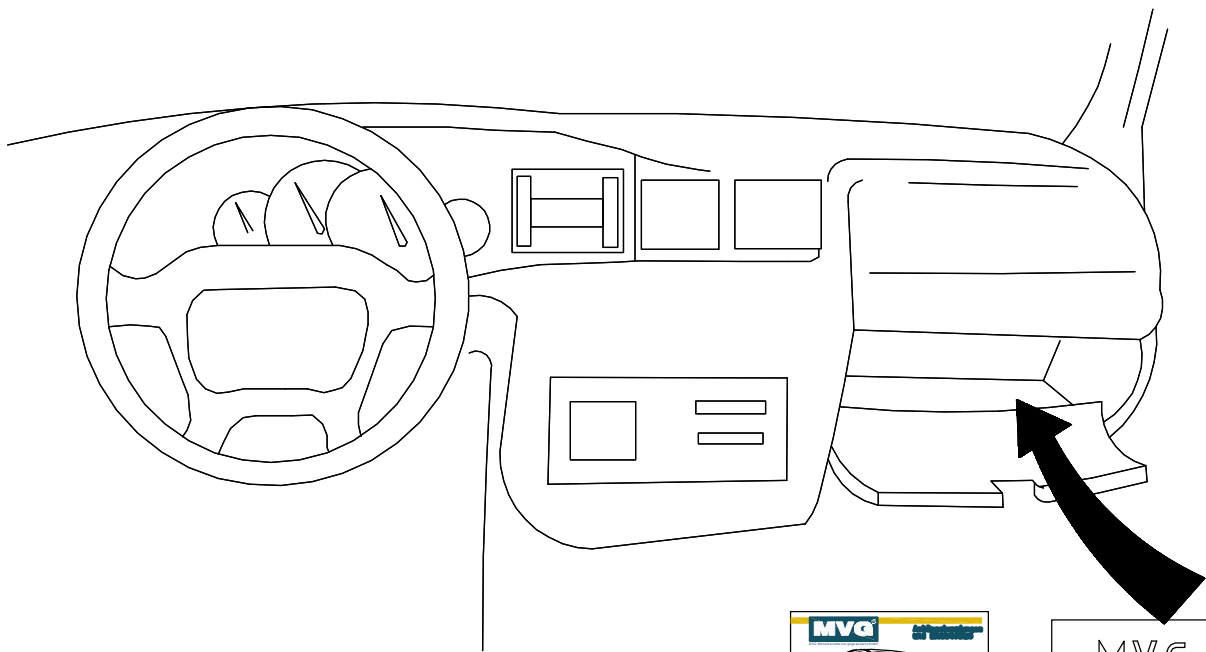

19

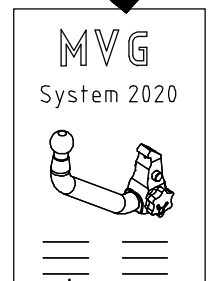

20

23