

Anhängekupplungen und Elektrosätze

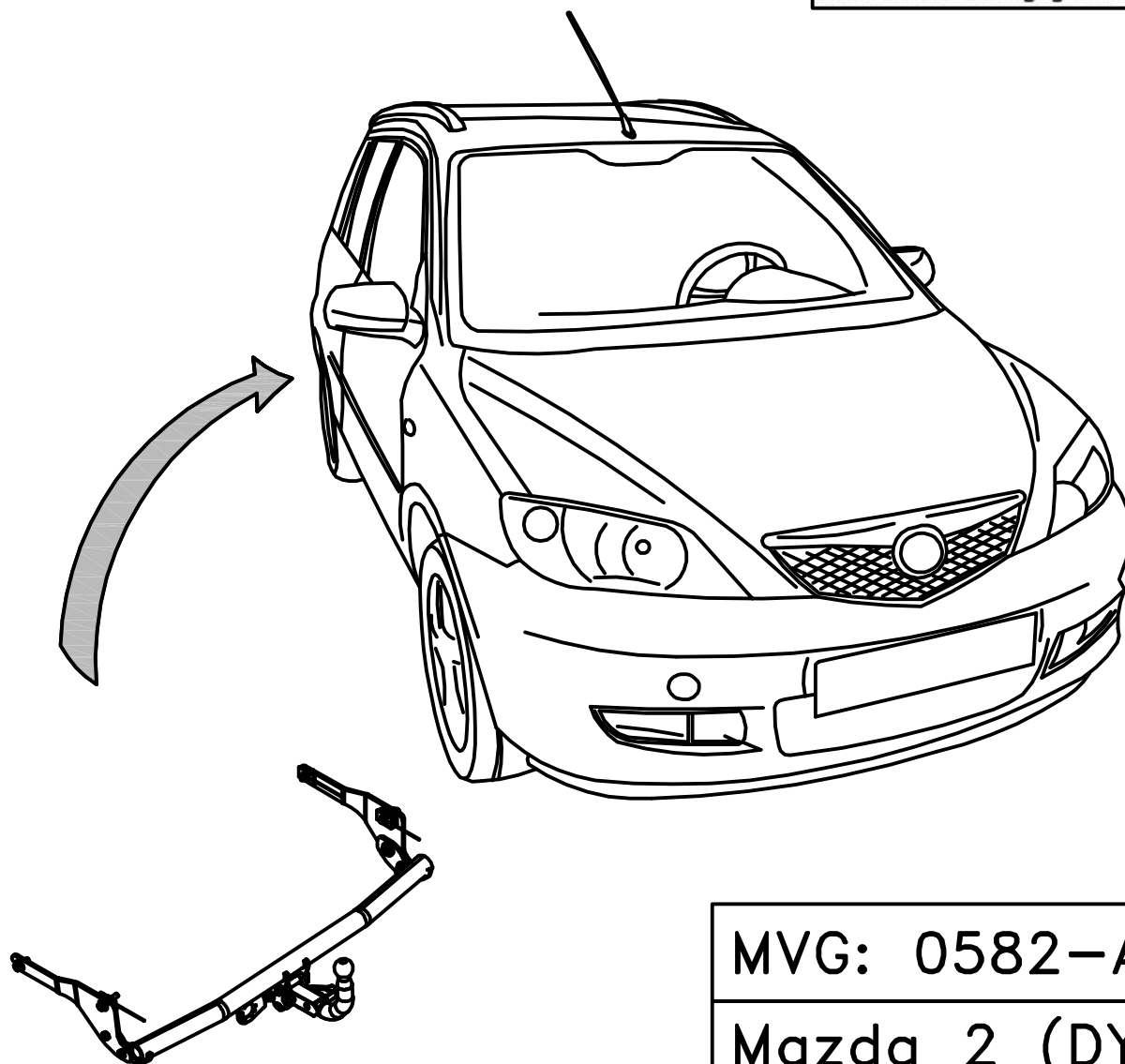

MVG: 0582-A

Mazda 2 (DY)

(E) Instrucciones de montaje

(D) Einbauanleitung

(GB) Installation instruction

(F) Notice de montage

(NL) Inbouw-instructie

(S) Monteringsanvisning

(CZ) Návod k montáži

(I) Istruzioni di montaggio

An der Wasserwiese 1
D-52249 Eschweiler

E-mail: info@mvg-ahk.de
Internet: www.mvg-ahk.de

Tel.: (02403)7902-61
Fax: (02403)7902-33

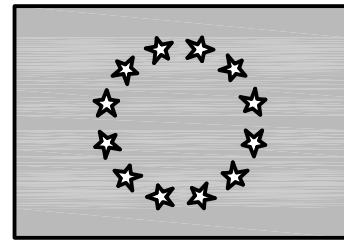
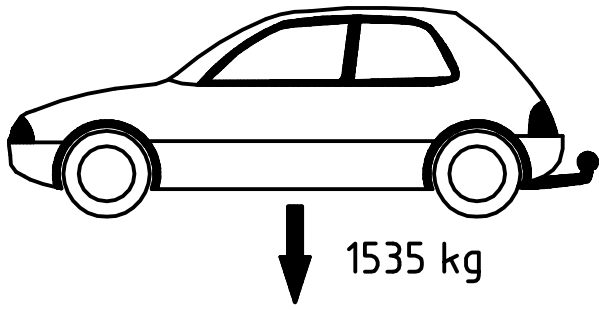

e1*2001/116*0212

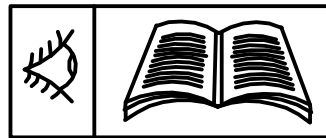

$$D = 5,8 \text{ kN}$$

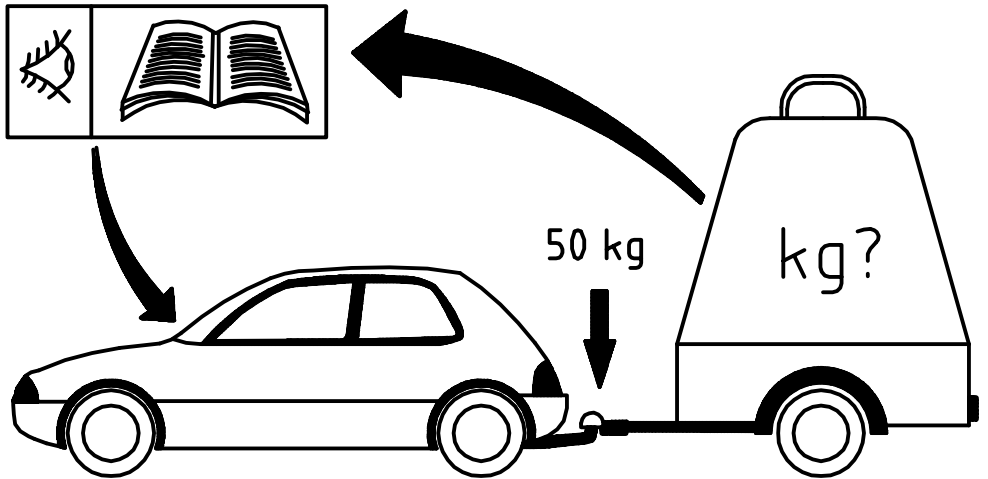

$$g = 9,81 \text{ m/s}^2$$



$$D = \frac{T \times R}{1000 \times (T+R)} \times g$$

$$T = \frac{R \times D \times 1000}{g \times R - 1000 \times D} \times g$$

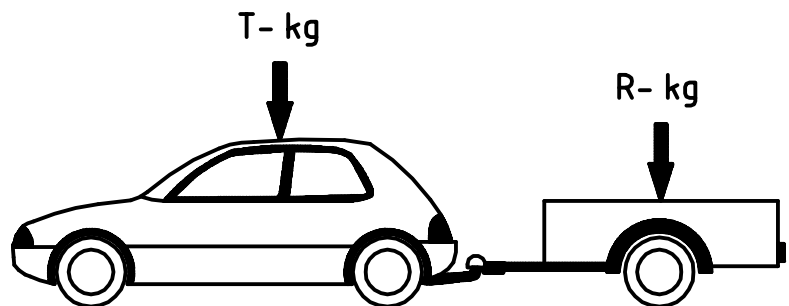
$$R = \frac{T \times D \times 1000}{g \times R - 1000 \times D}$$

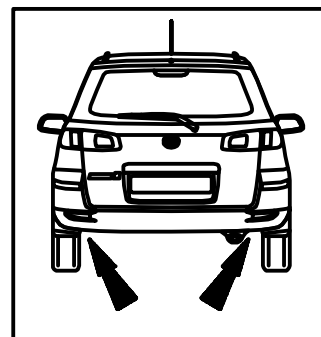
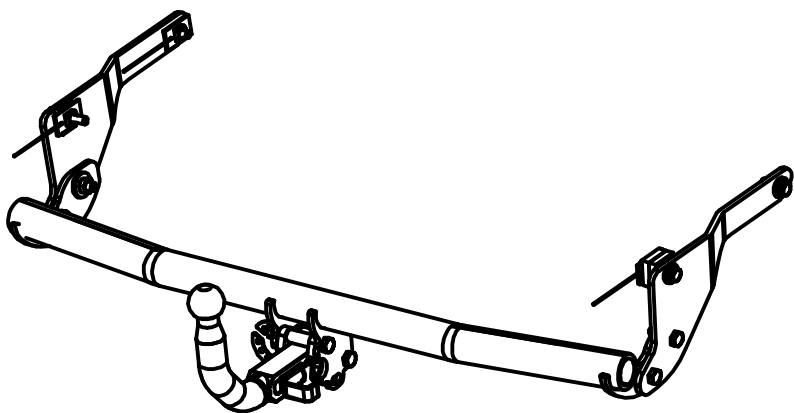
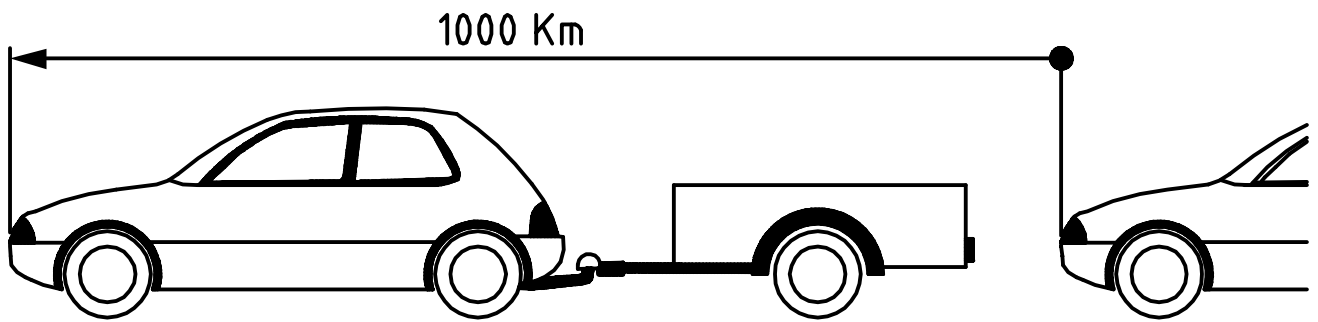
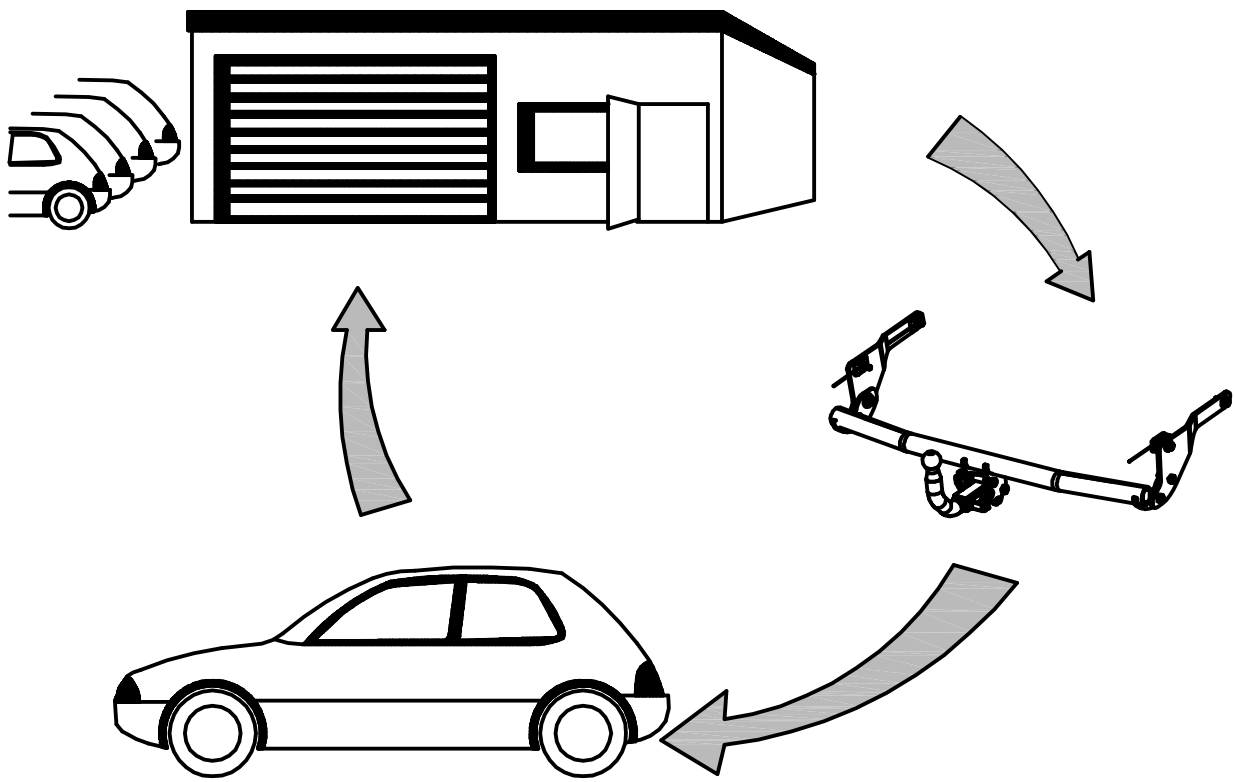





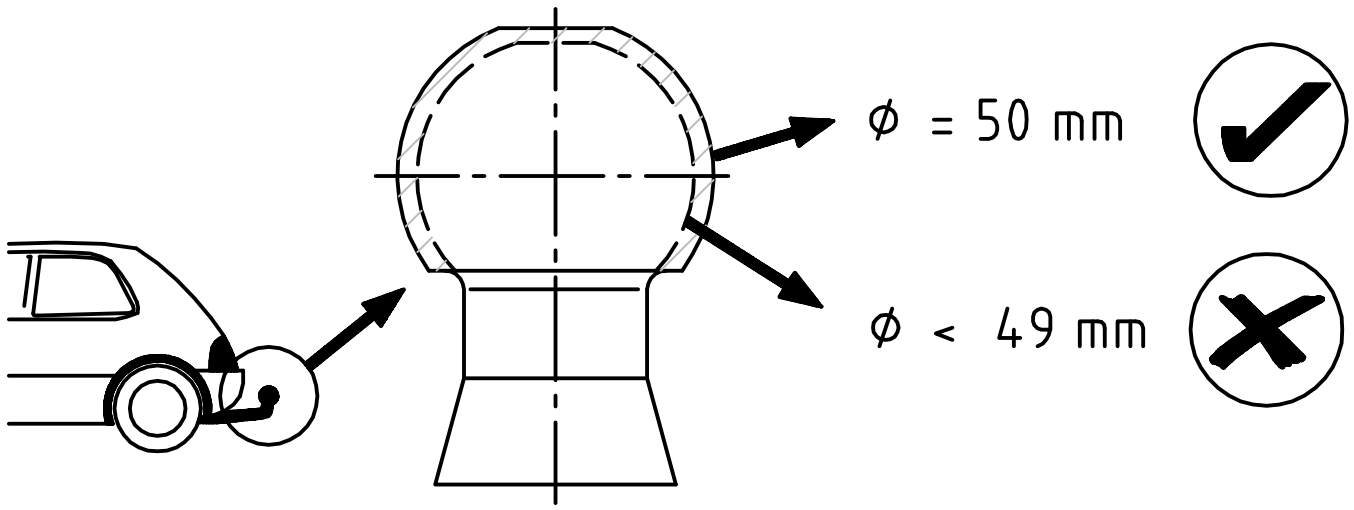





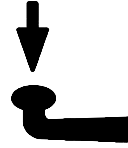

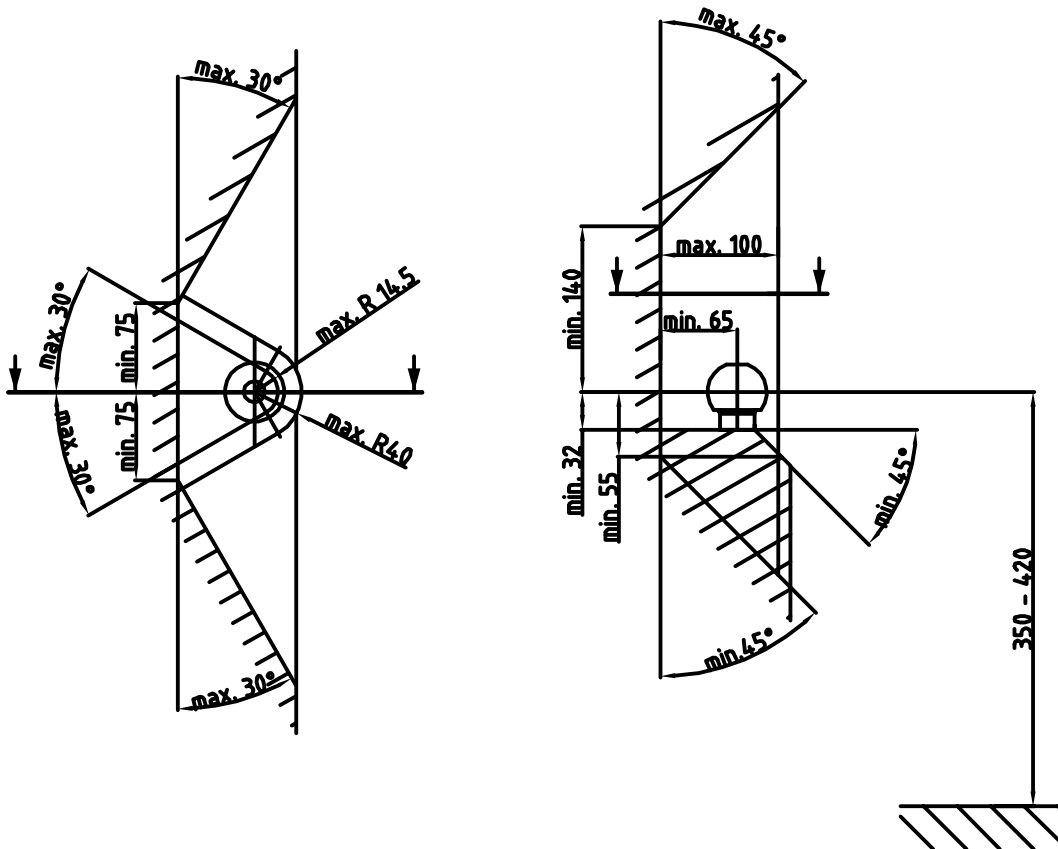

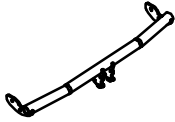









 <p>M10; M12</p>	<p>0 Km</p> 	<p>1000 Km</p> 
---	---	--









	316	Approval Number e4 00- 3281
	Type: 0582 A Class: A50-X Made in Germany	D-Value: 5,8 kN S-Value: 60 kg www.mvg-ahk.de

Zulässige Stützlast
 maximal 50 kg

1	1x		0582-A
2	1x		2010-B-19.0
3	1x		rechts
4	1x		links
5	2x		rechts
6	1x		links
7	4x		
8	4x		∅ 28x10,5x4 DIN 6340
9	4x		A10 FSt. DIN 127
10	2x		M10x35 (8.8) DIN 933
11	2x		M10x55 (8.8) DIN 931
12	4x		M12x40 (8.8) DIN 931
13	4x		∅ 35x13x5 DIN 6340
14	6x		M12 (10) DIN 980V
15	1x		∅ 24x13x2,5 DIN 125
16	2x		M12x100 (8.8) DIN 931
17	1x		
18	1x		
19	1x		System 2010-A
20	1x		

21	1x	
22	1x	
23	2x	
24	1x	
25	1x	 50kg
26	1x	

E

Elementos que se aportan

D

Lieferumfang der Anhängervorrichtung

GB

Scope of delivery of towing hitch

F

Pièces comprises dans la fourniture de l'attelage

NL

Leveringsomvang trekhaak

S

Dragkrokens leveransspecifikation

CZ

Objem dodání tažného zařízení

I

Dotazione del gancio di traino

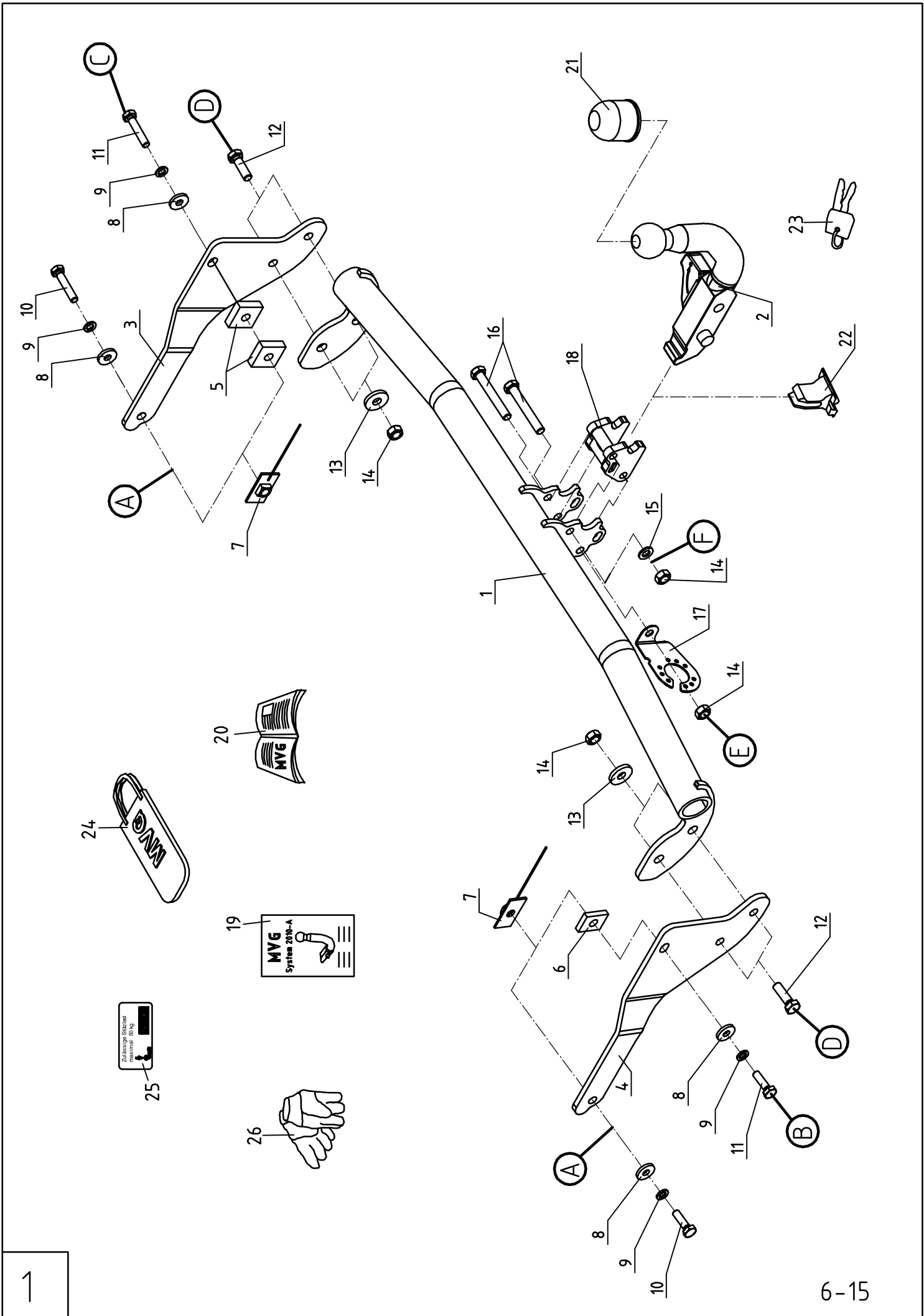

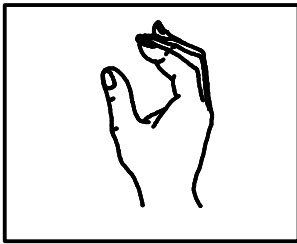
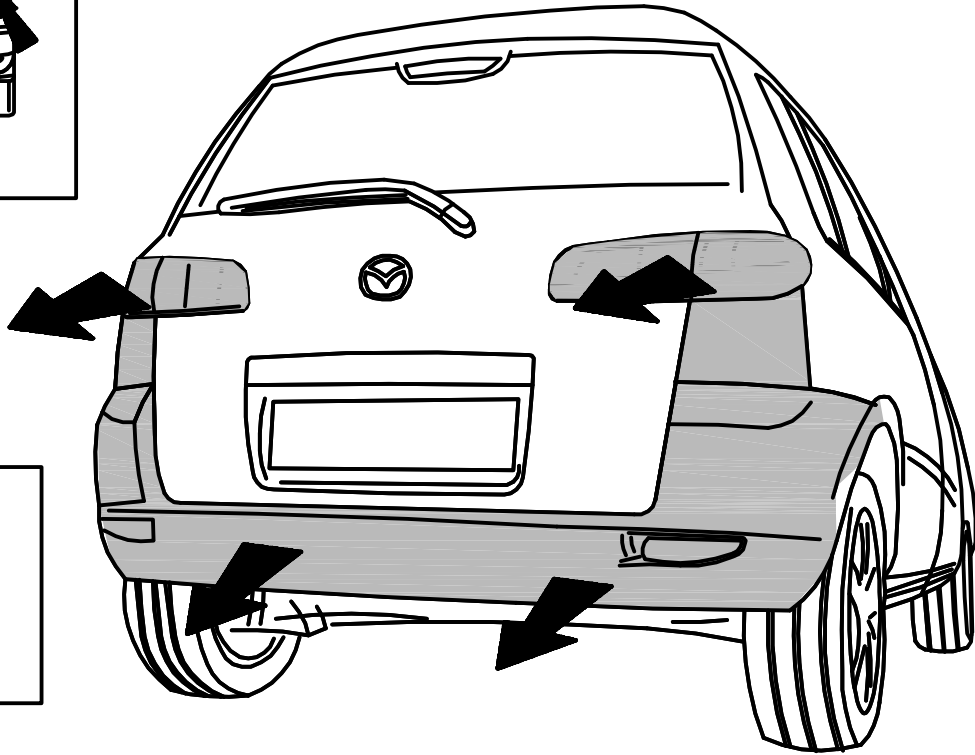
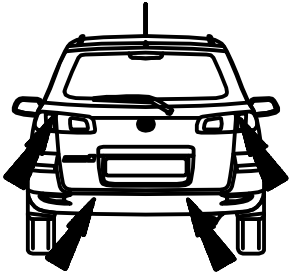

2

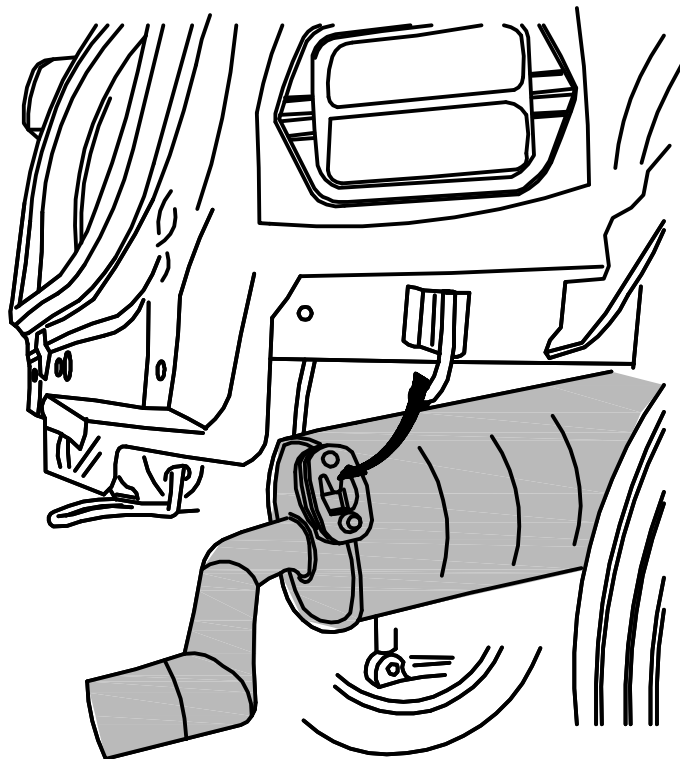
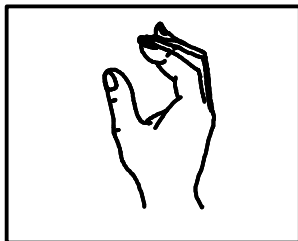
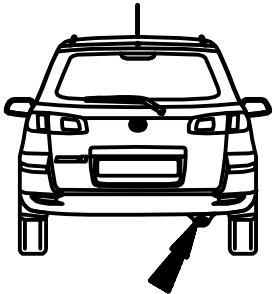

3

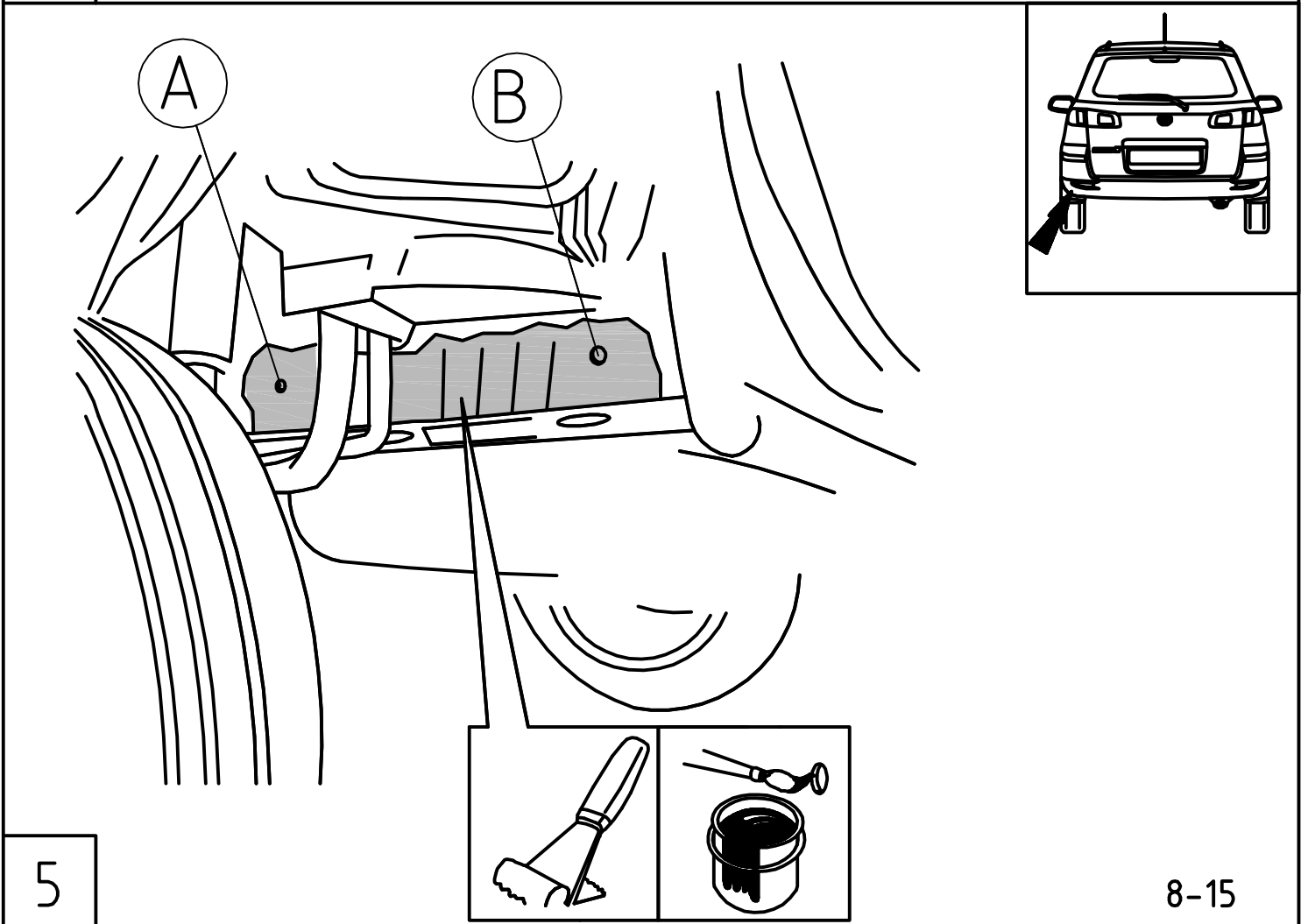
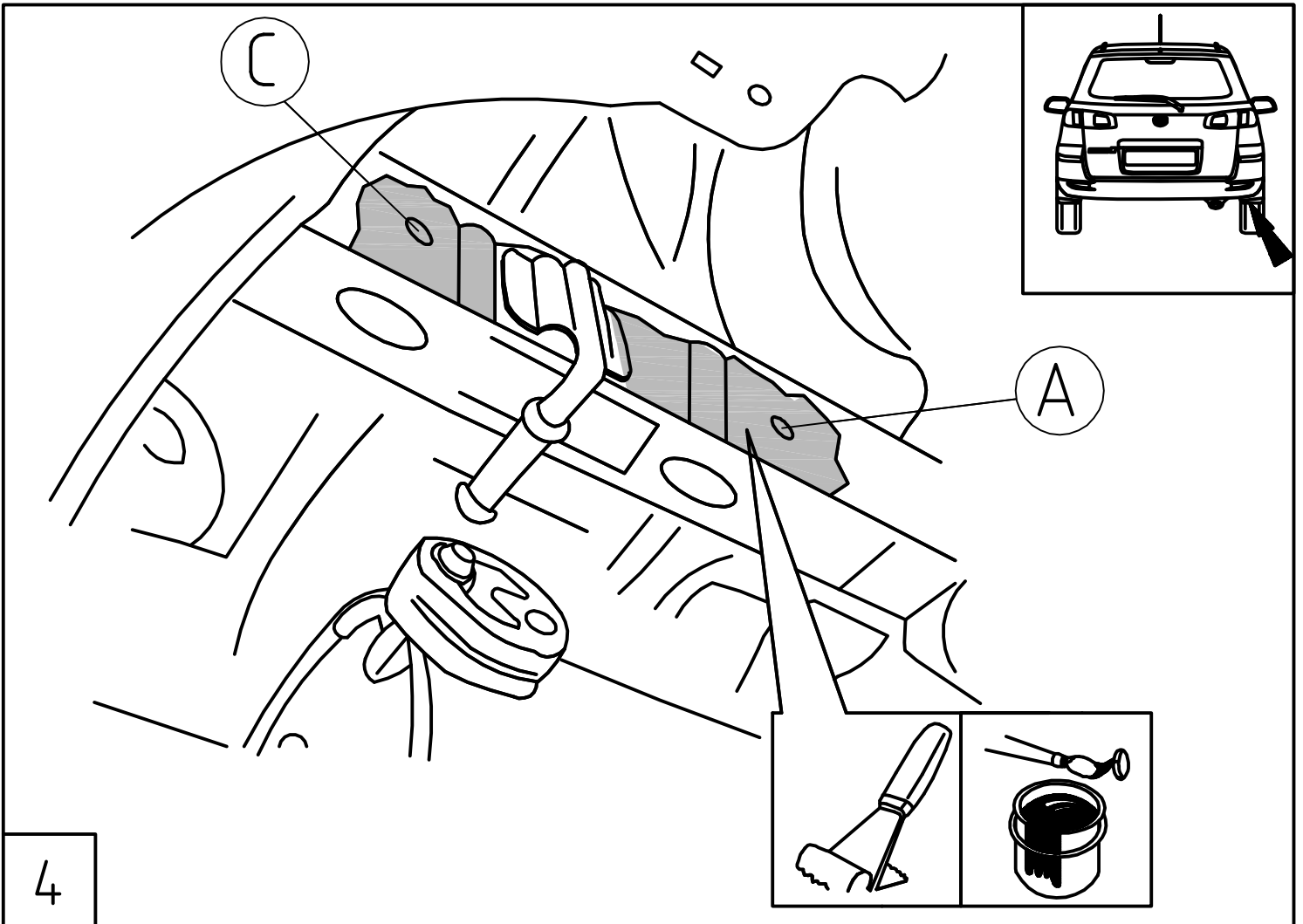

10;9;8

11;9;8;6

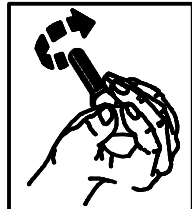
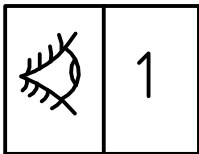
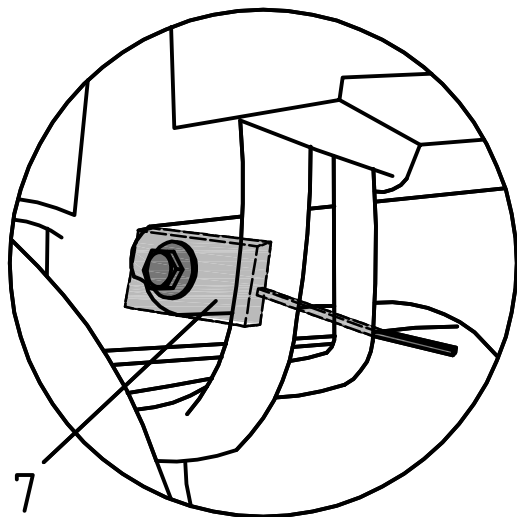
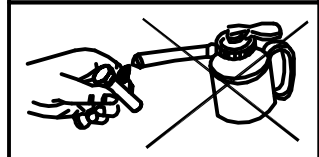
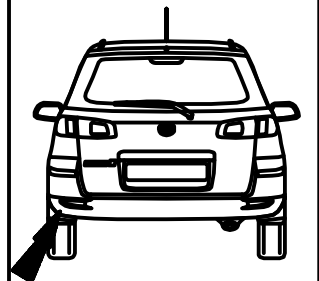
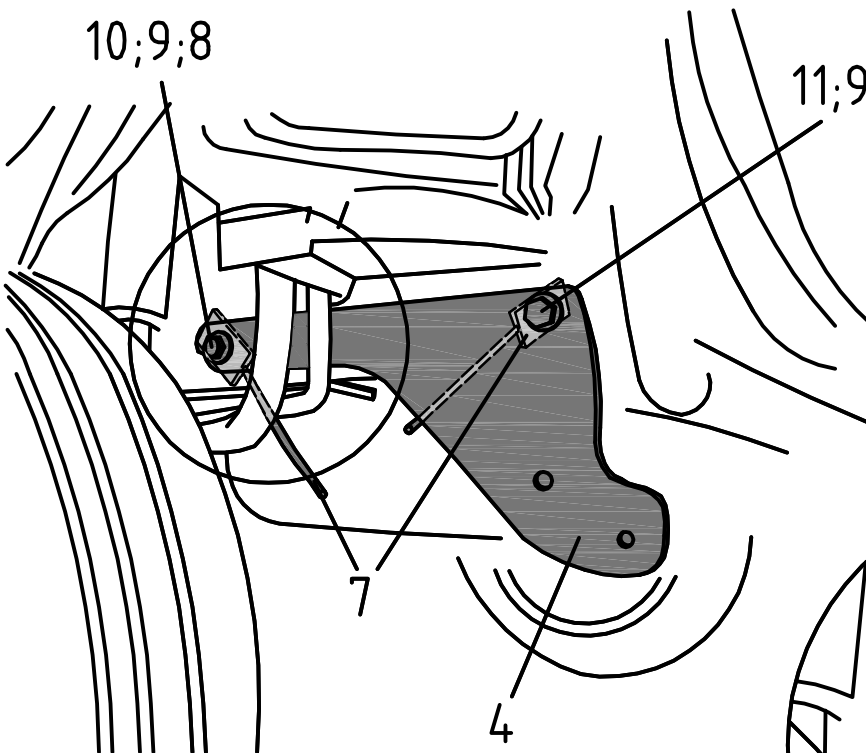

6

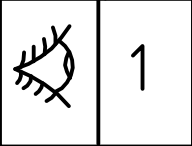

11;9;8;5;5

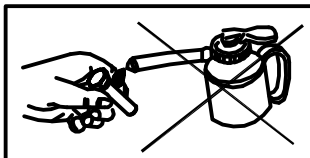
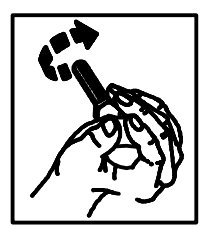
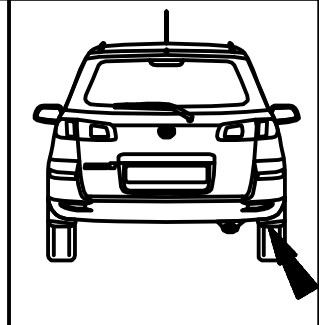
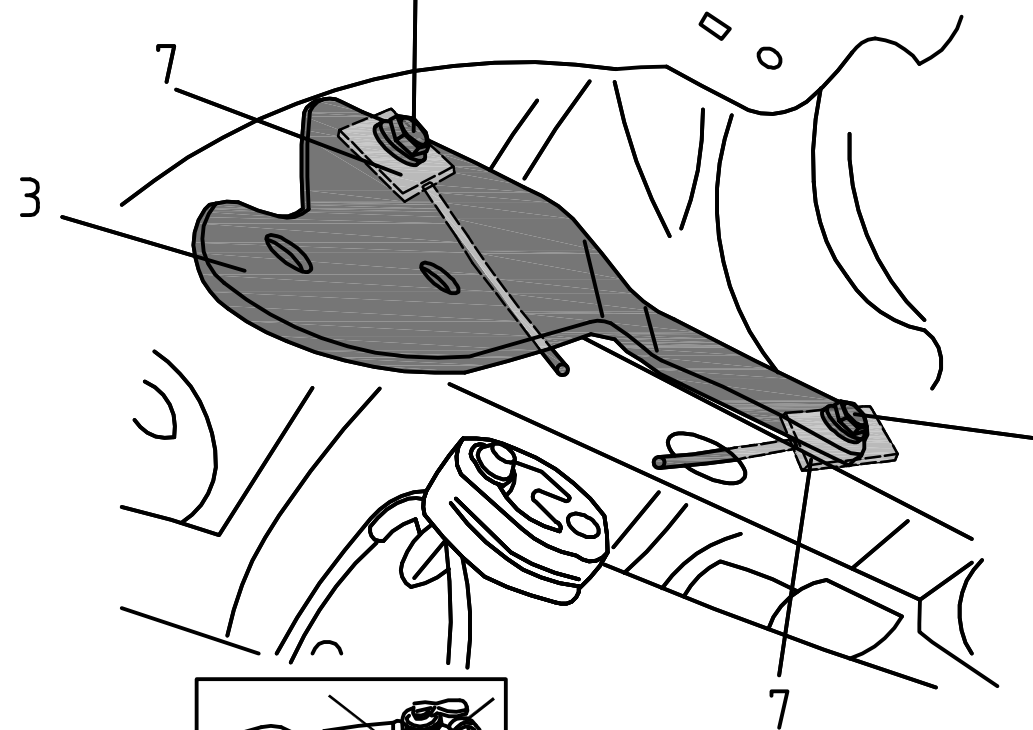

7

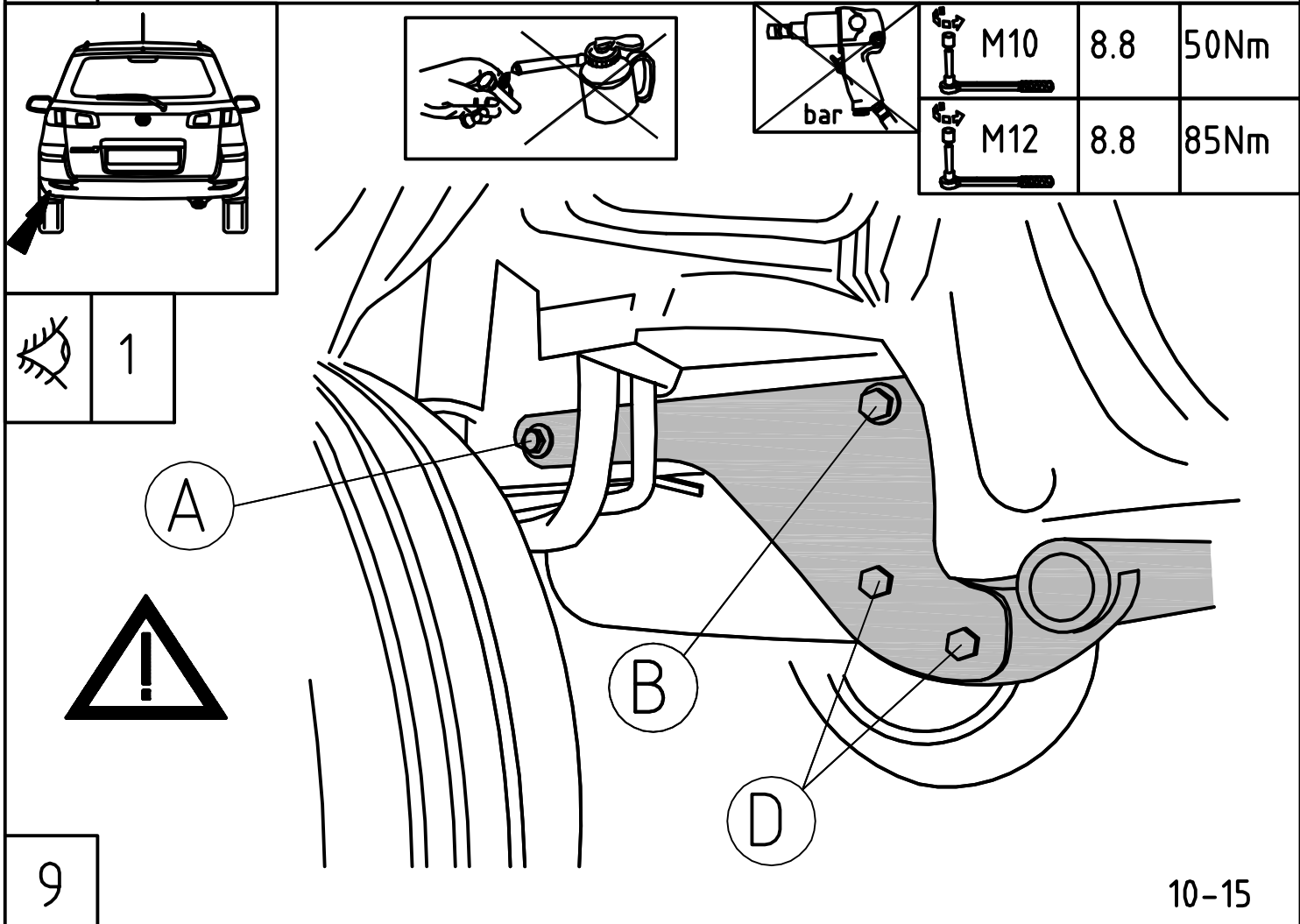
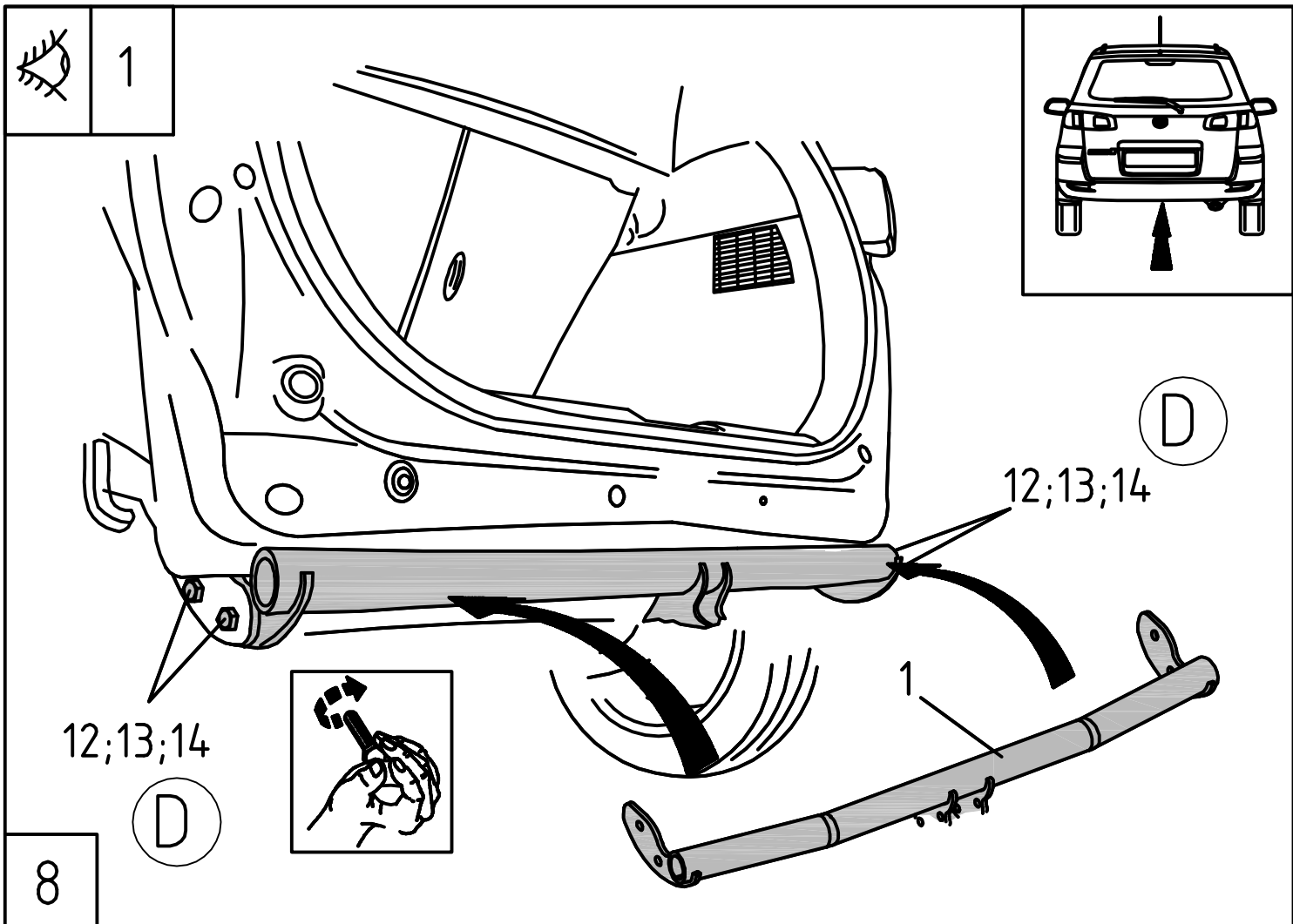

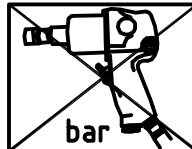
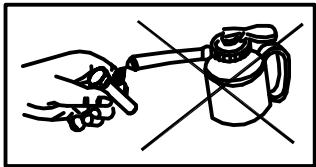
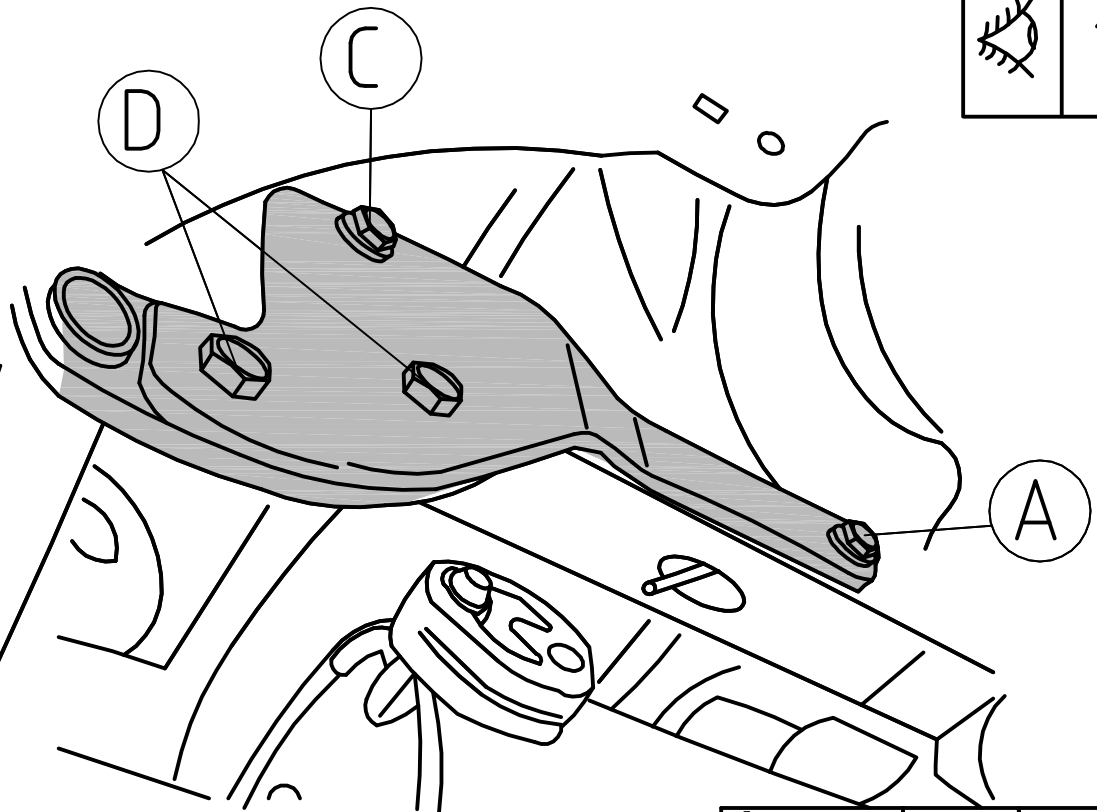
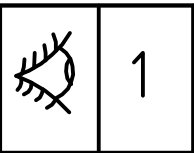
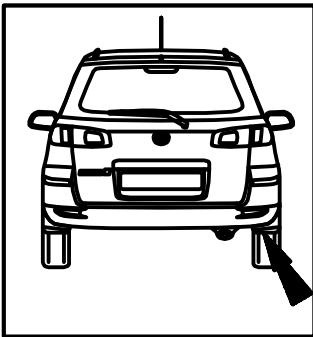

	M10	8.8	50Nm
	M12	8.8	85Nm

10

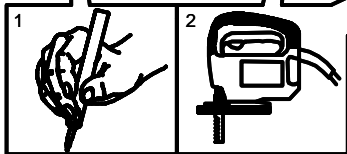
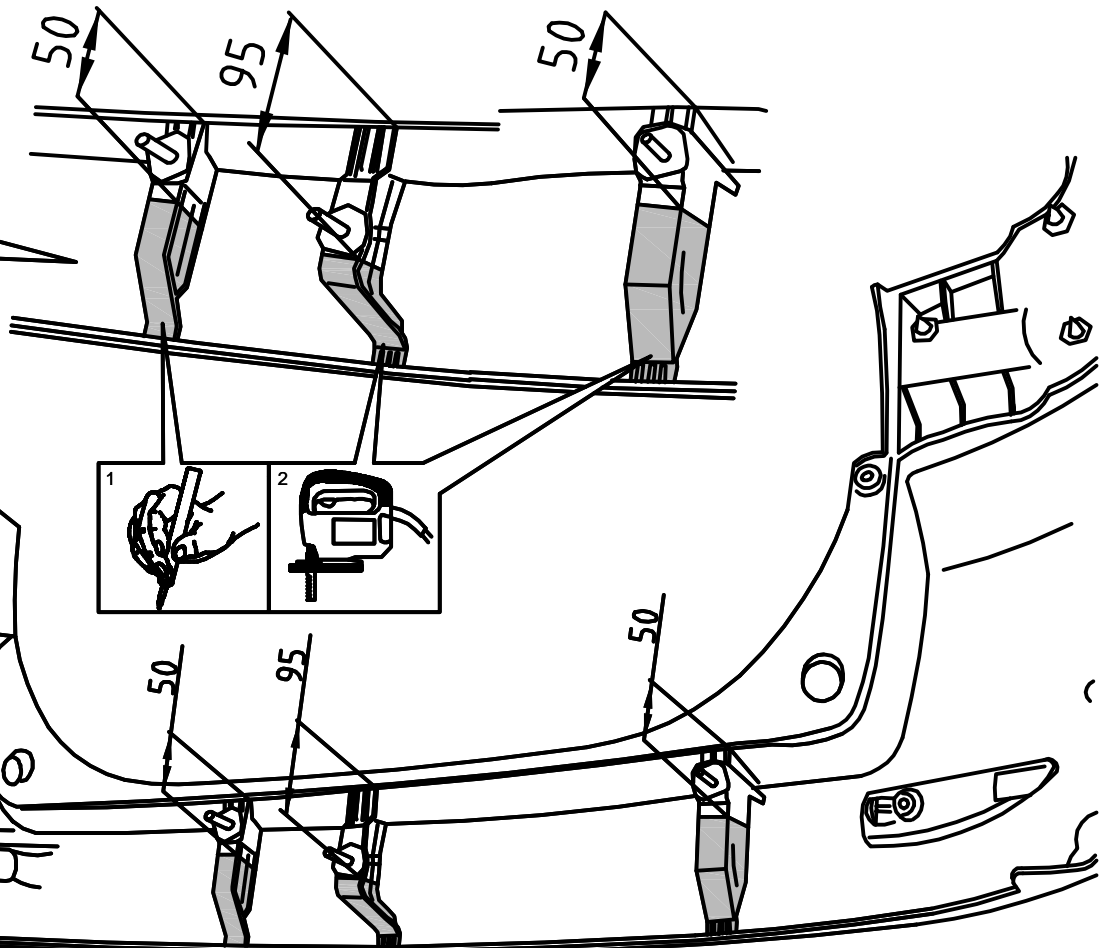

11

11-15

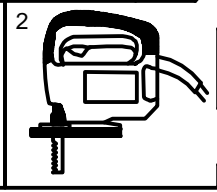
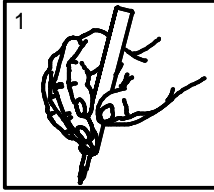
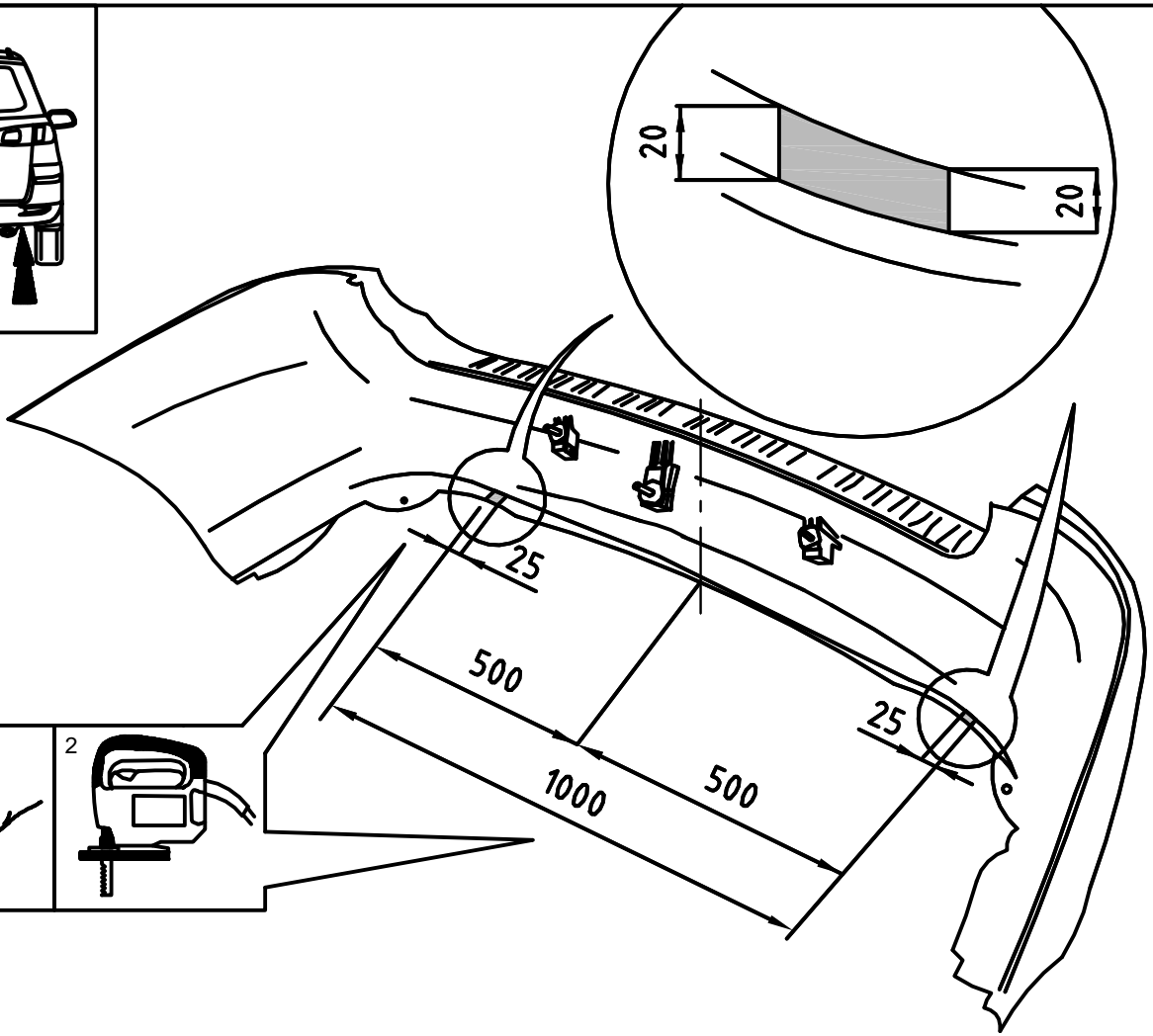
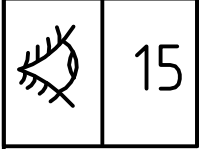
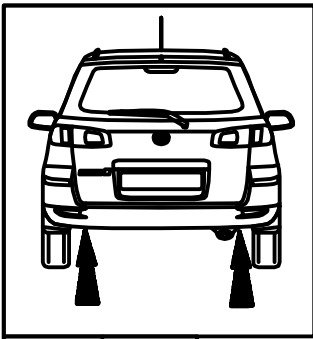

12

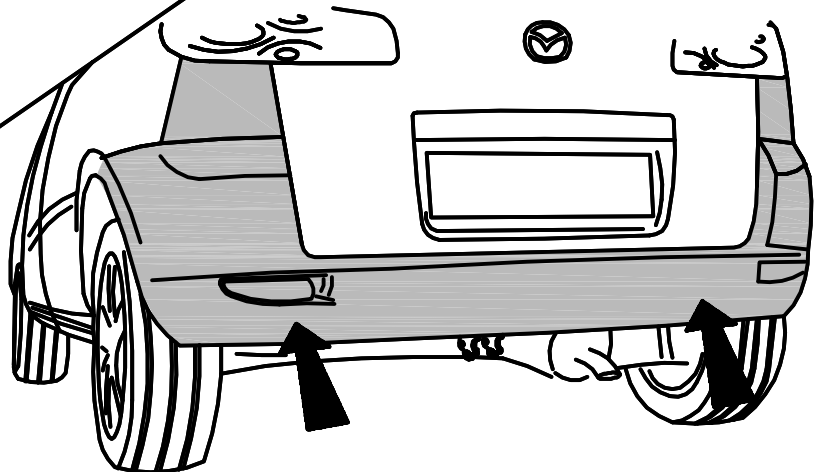
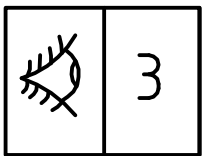
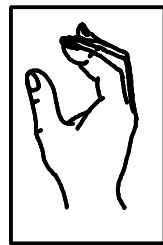
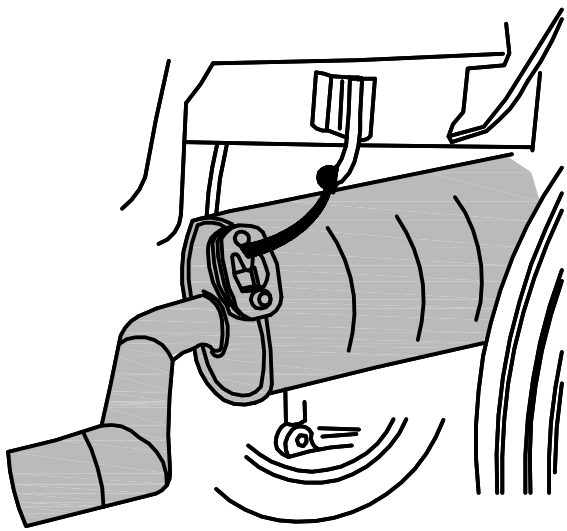

13

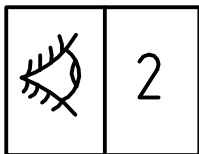



2

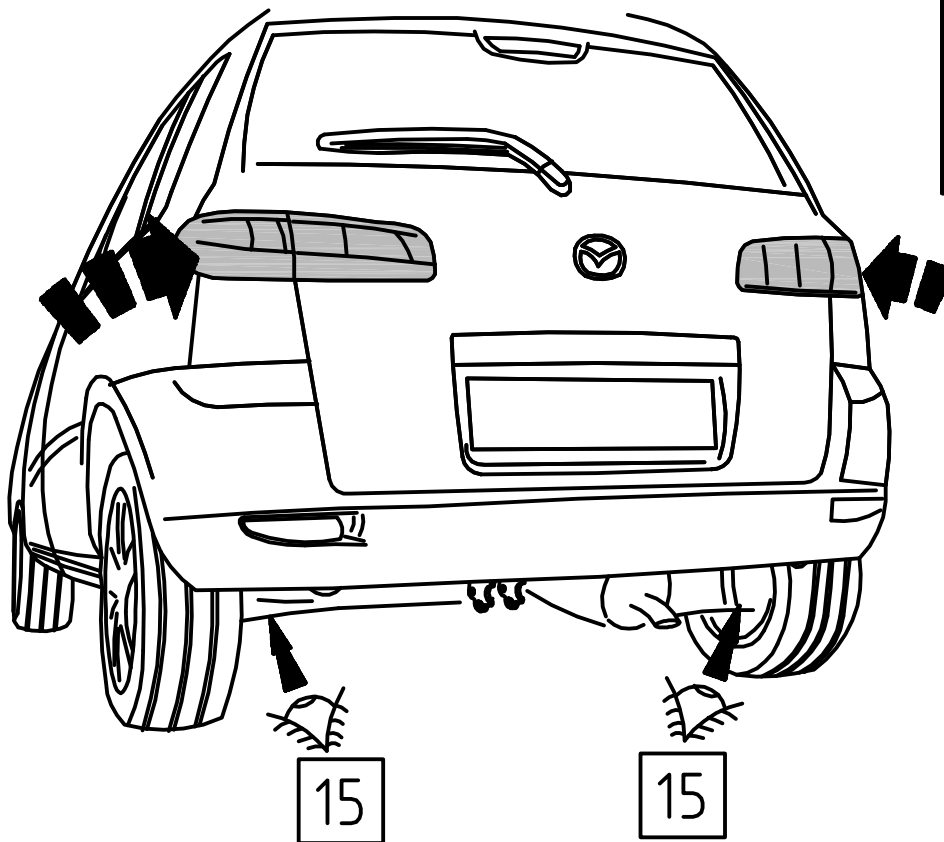
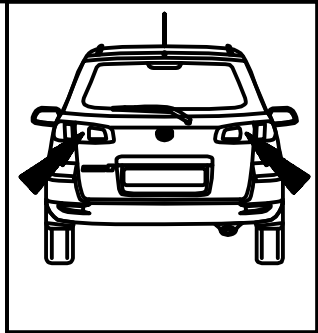

14



12

14

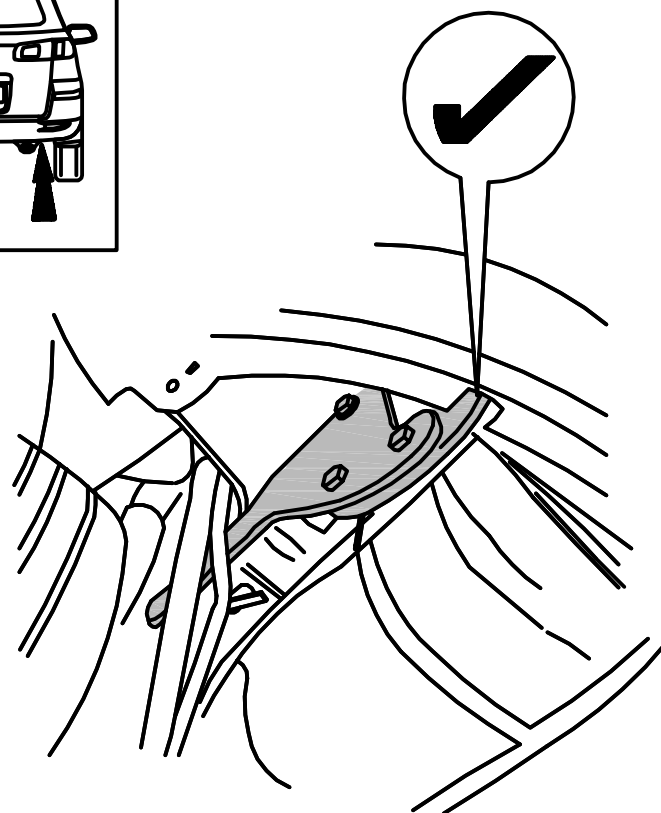
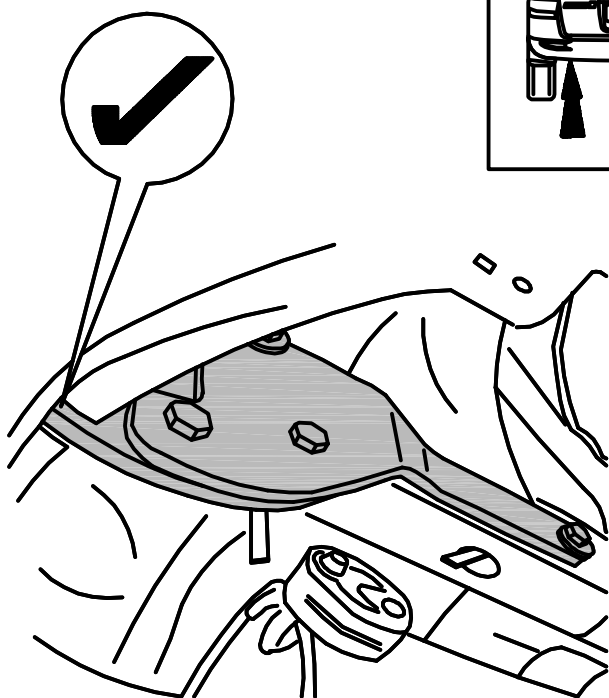
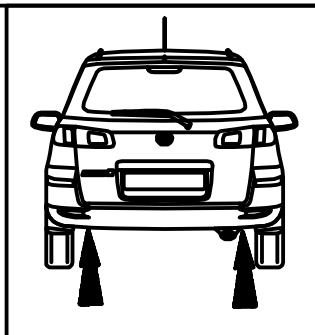

15

13-15

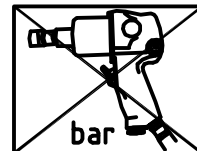
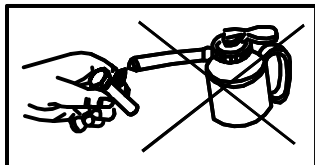
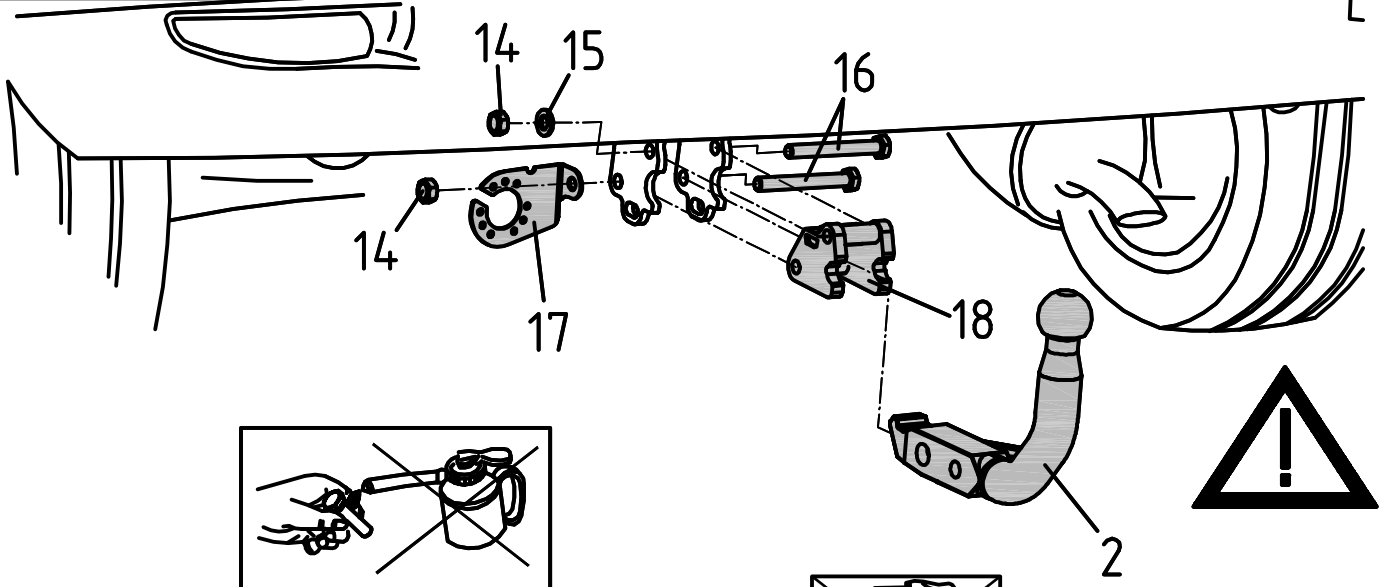
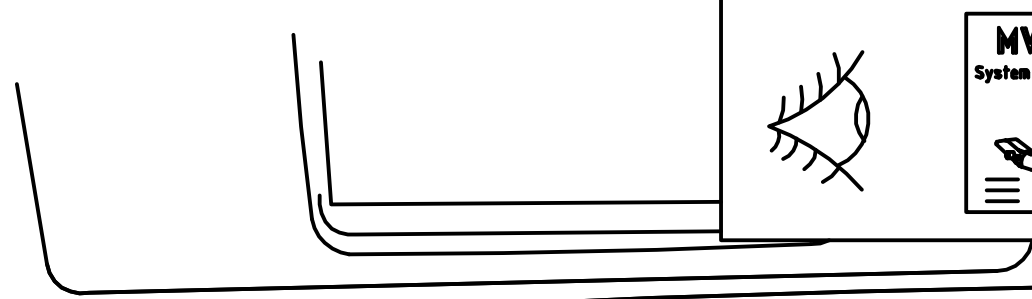
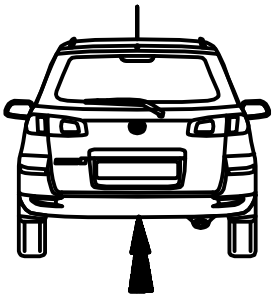

M12	8.8	85Nm
-----	-----	------

16

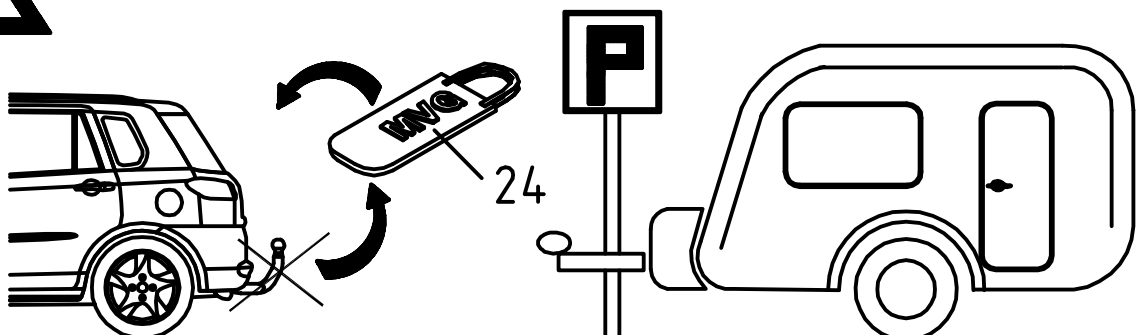
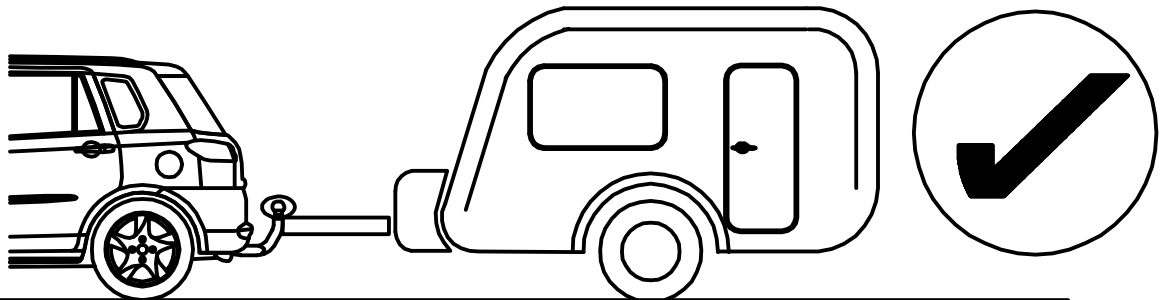

17

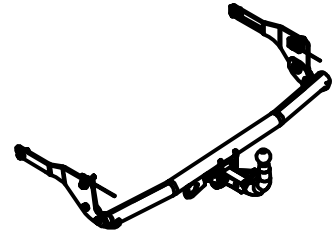
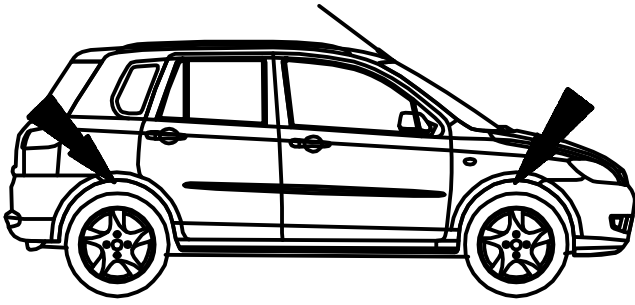

Best. Nr.: 0582 A

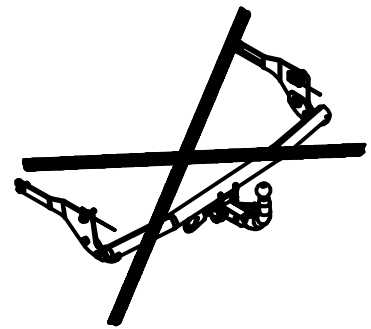
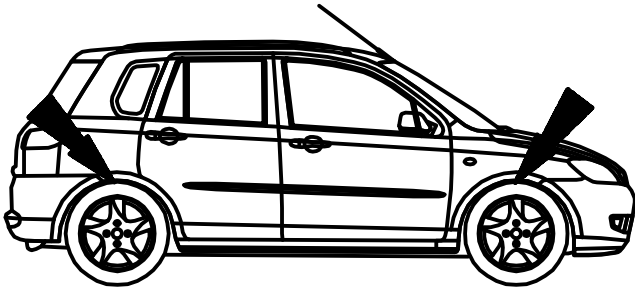

18

Technische Änderungen vorbehalten

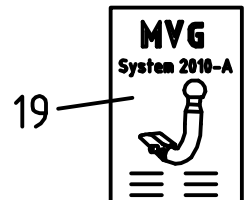
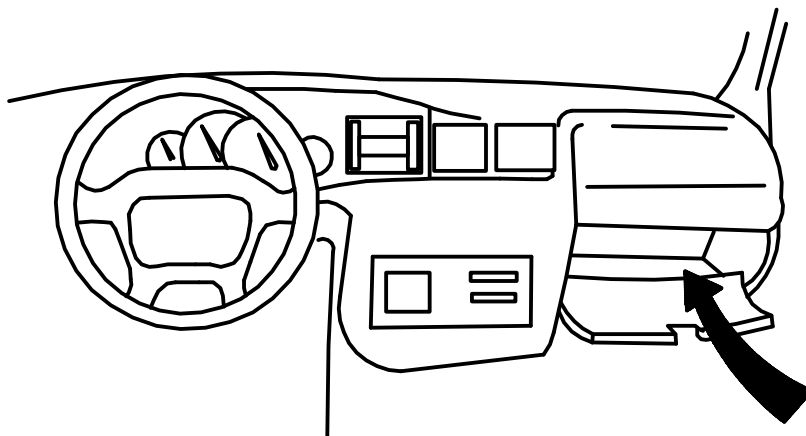
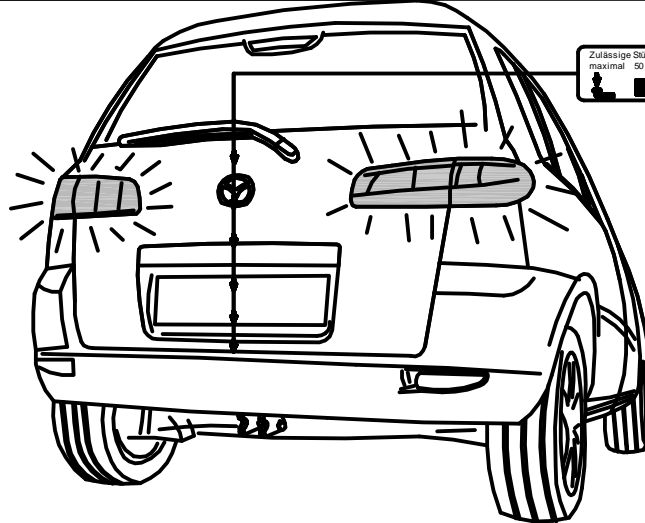
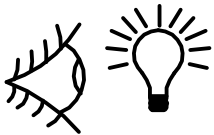

19

15-15