

x 1

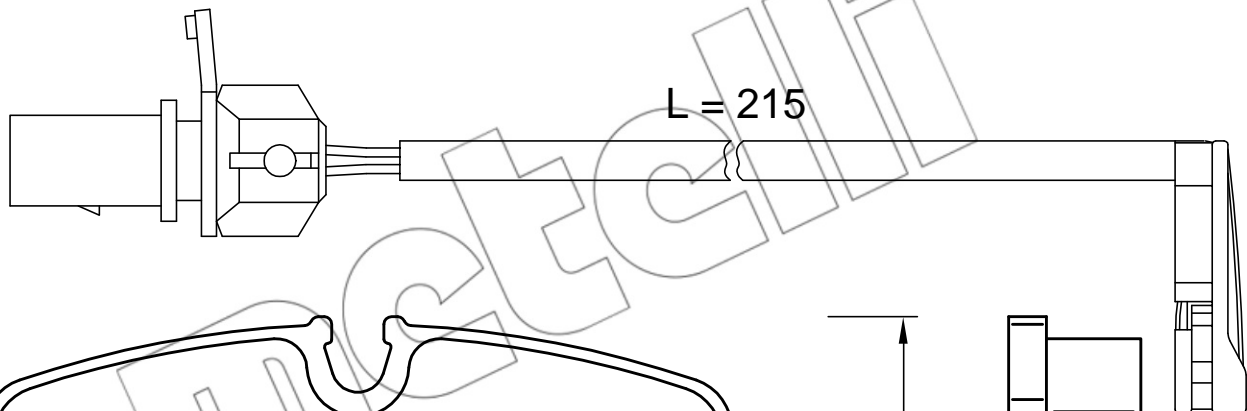

x 2

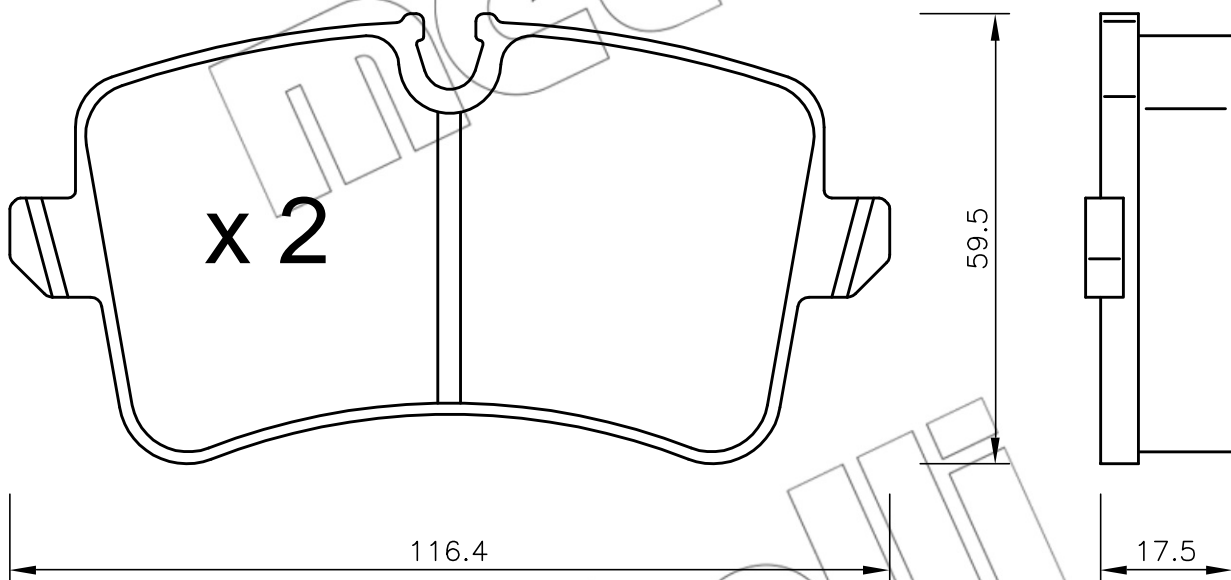

x 2

