

x 2

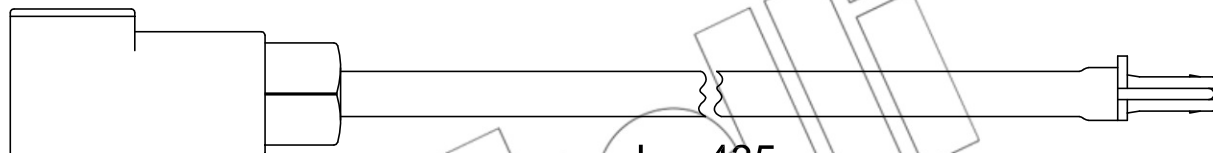

L = 435

x 4

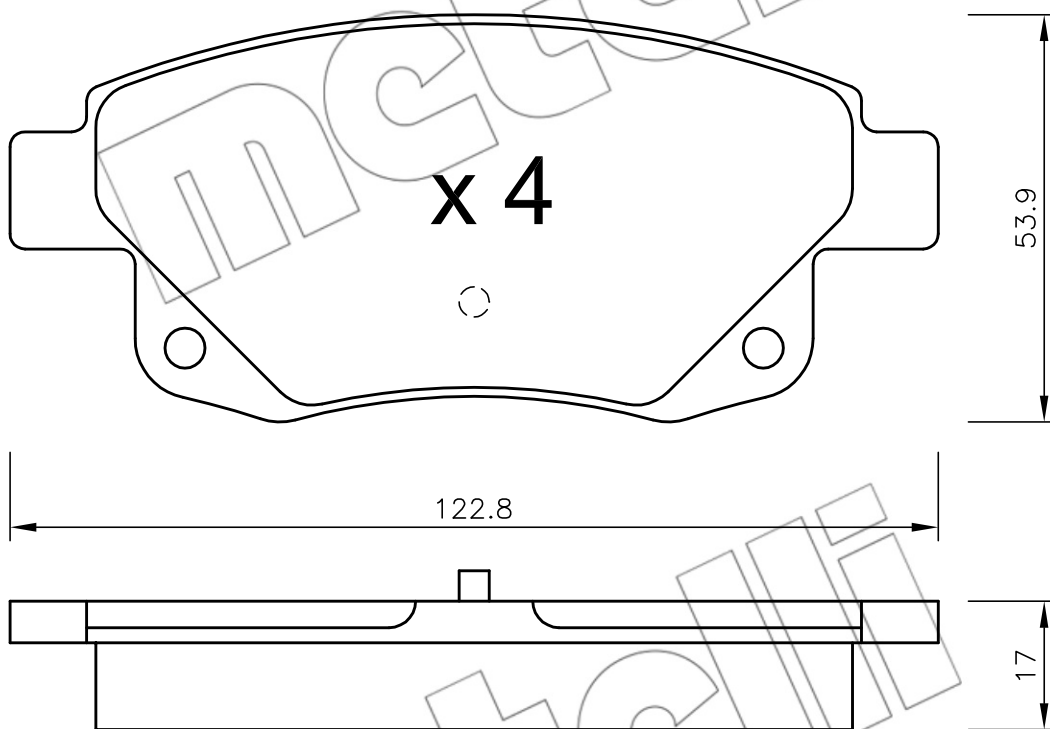

53.9

122.8

17

metelli