

L = 280

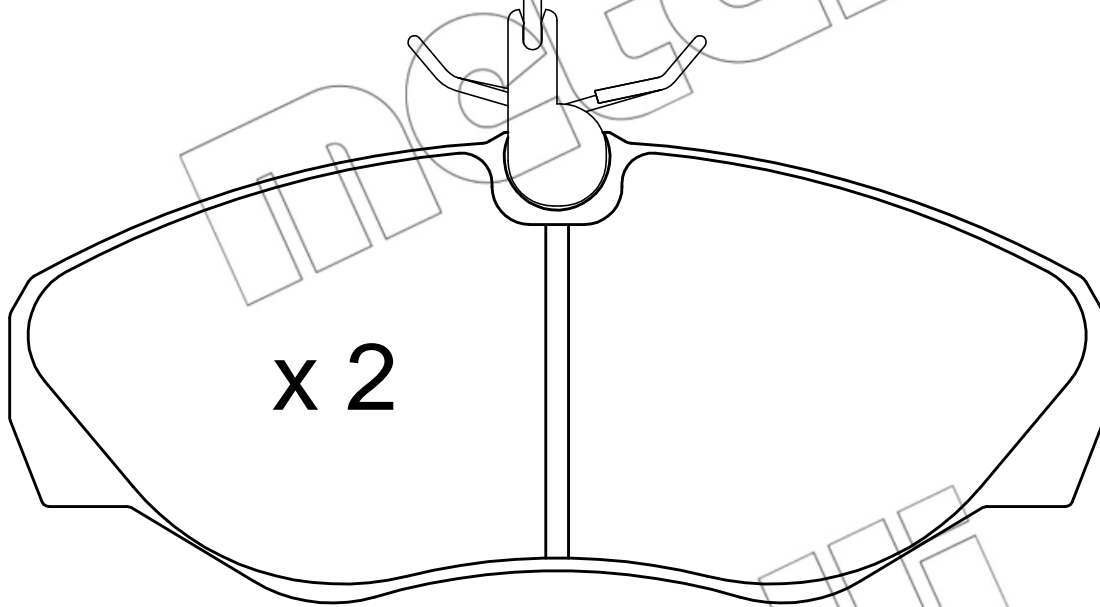

x 2

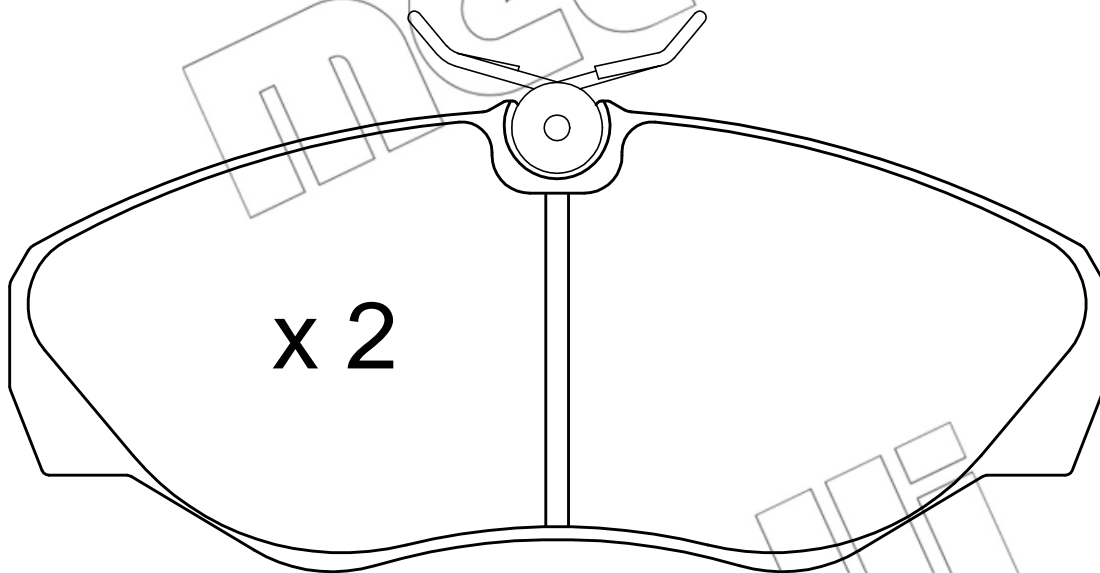
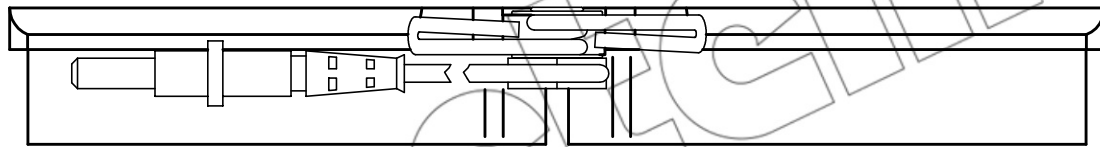

x 2

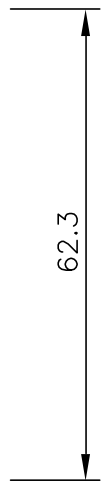

62.3

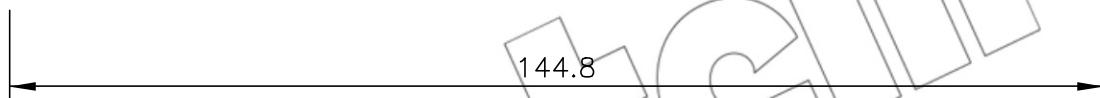

144.8

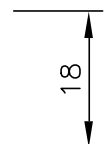
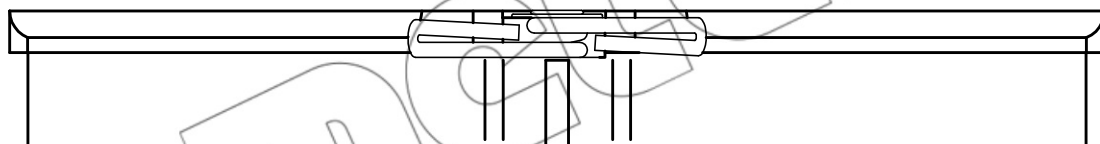

18