

x 1

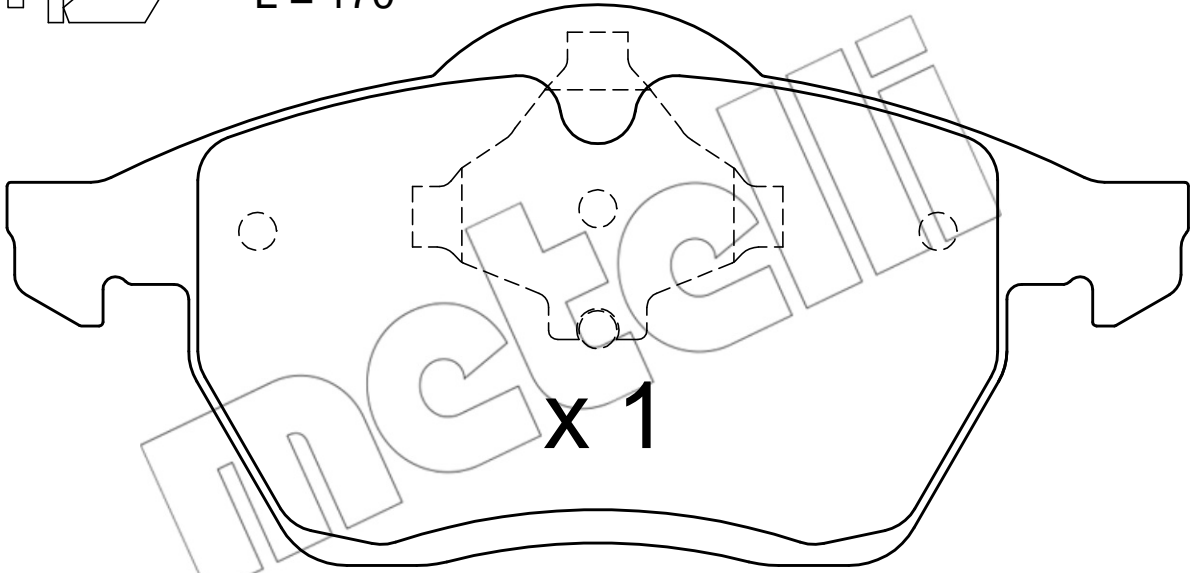

x 1

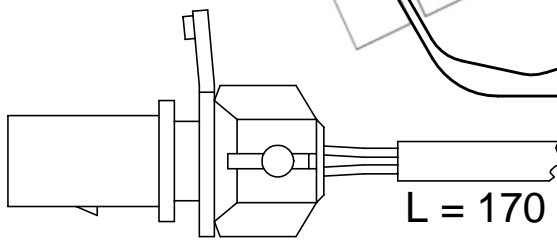
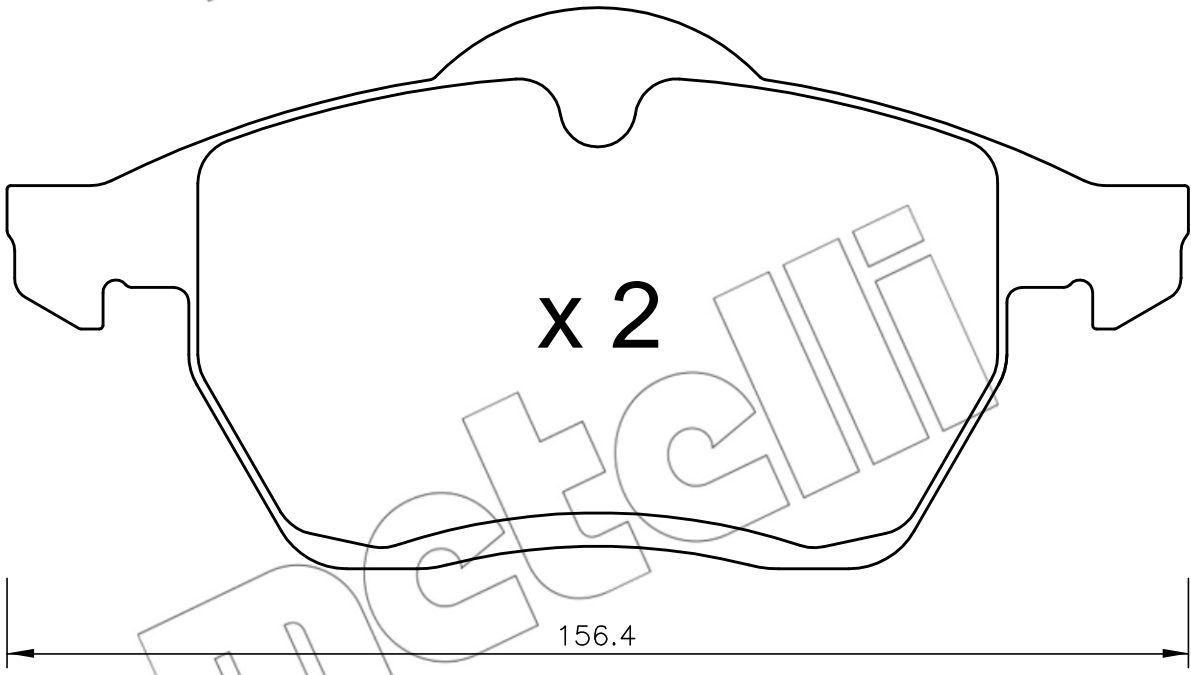

x 2

156.4

74.3