

L = 195

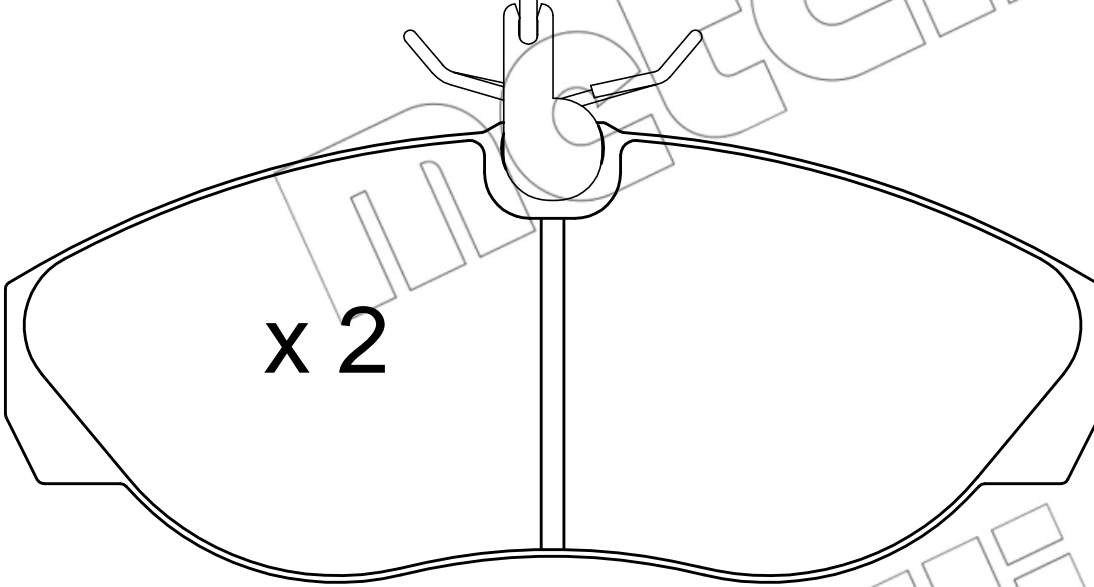

x 2

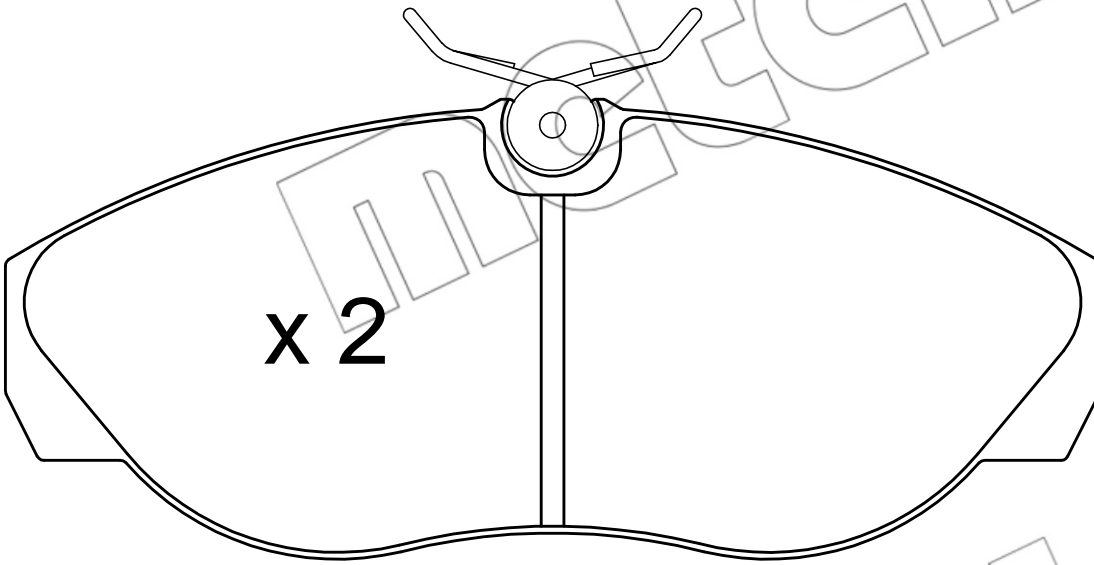
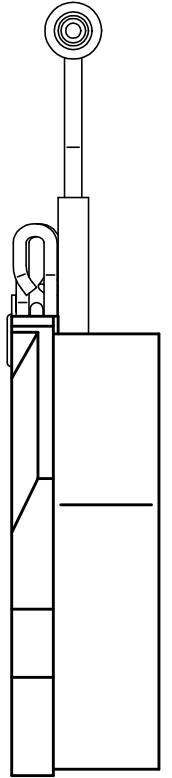

x 2

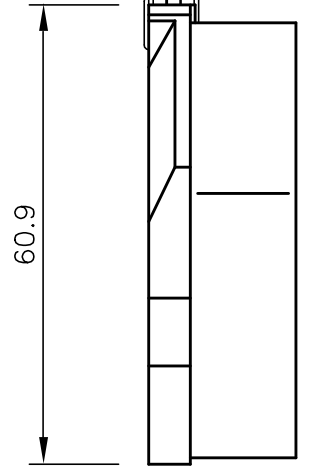

60.9

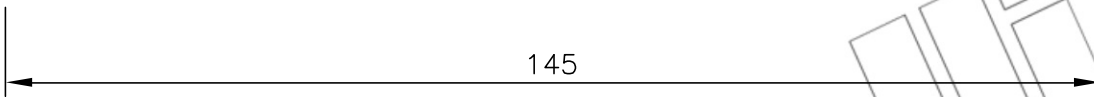

145

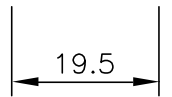

19.5