

x 4

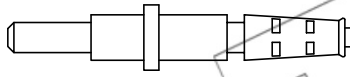

L = 175

x 4

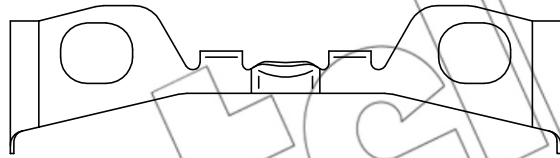
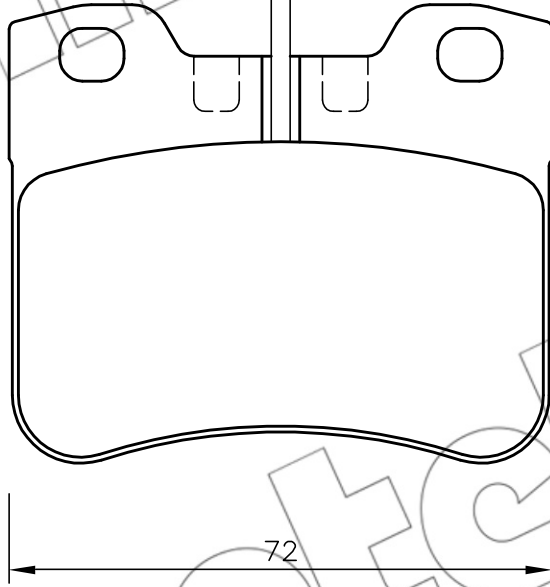

60.8

72

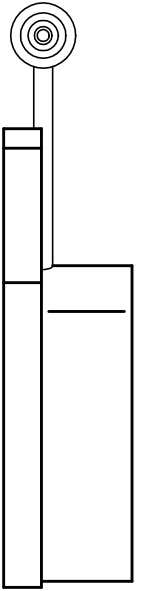

17

metelli