

L = 195

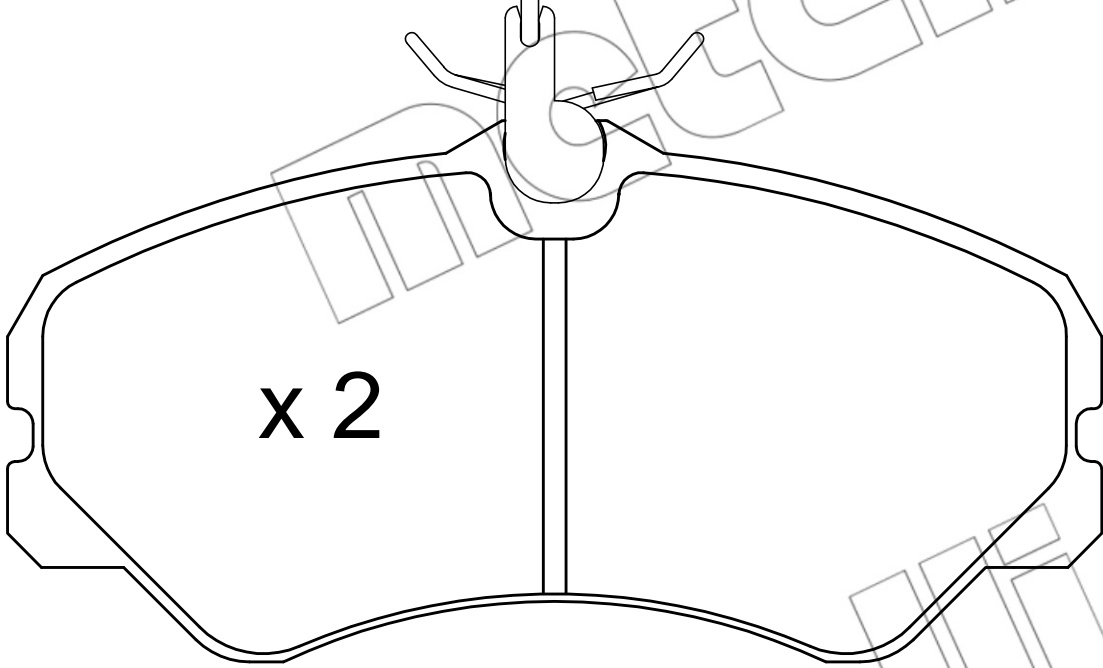

x 2

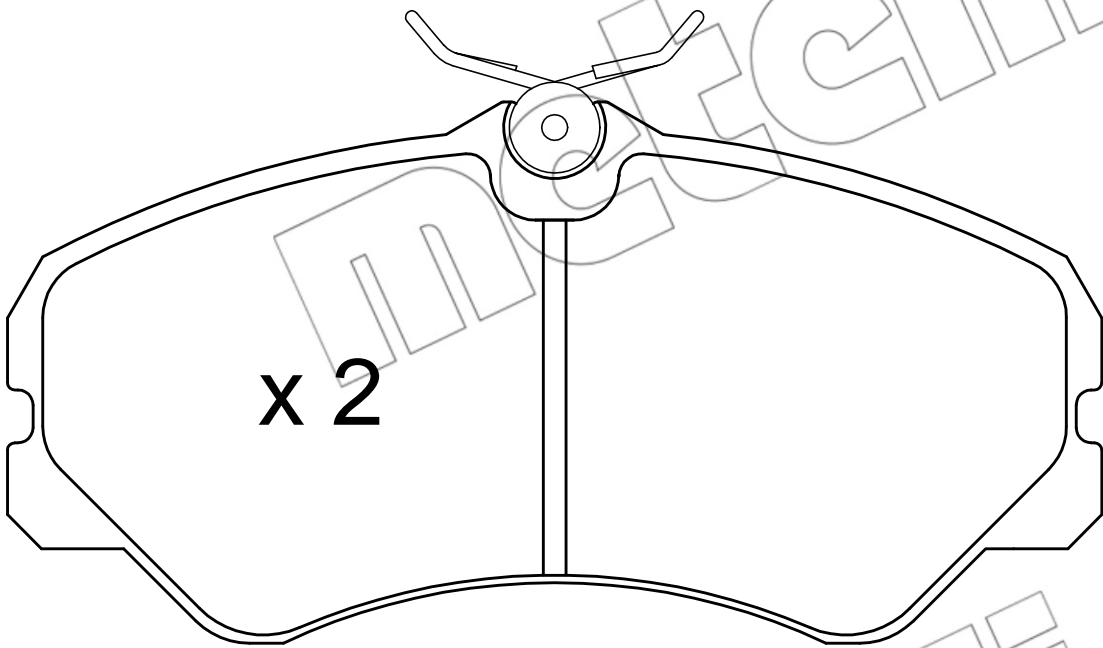

x 2

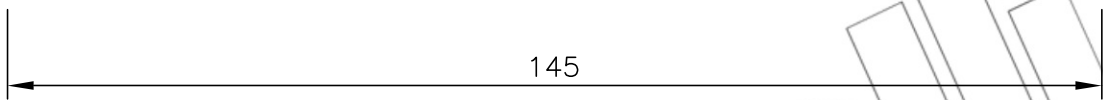

145

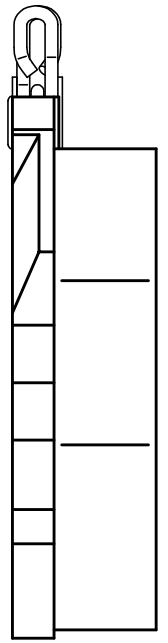
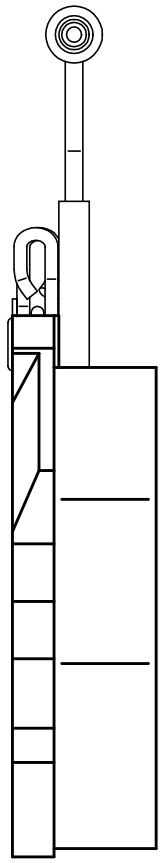

71.8

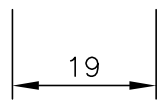

19