

x 2

L = 210

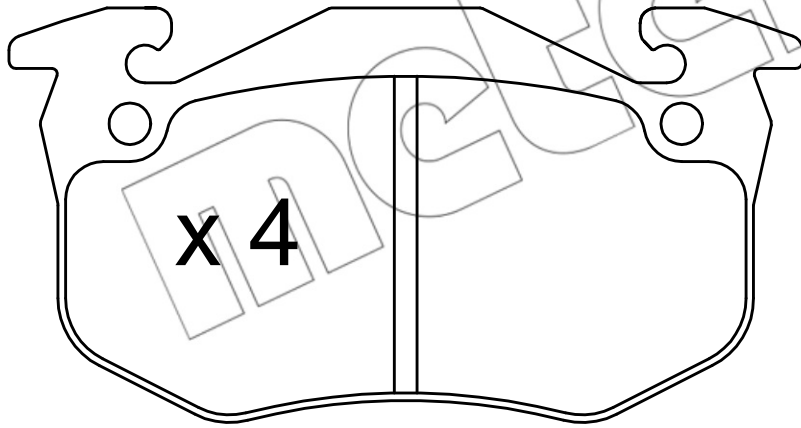

x 4

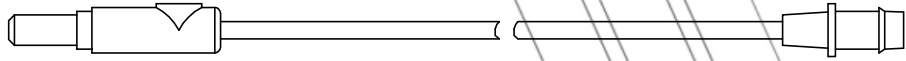
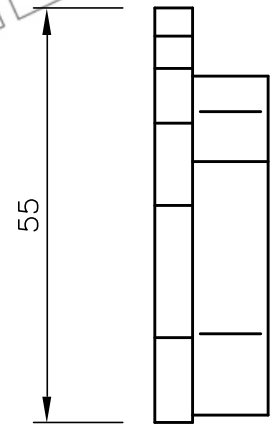

55

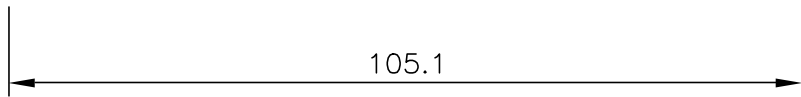

105.1

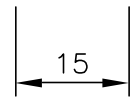

15

metelli

metelli