

L = 155

x 2

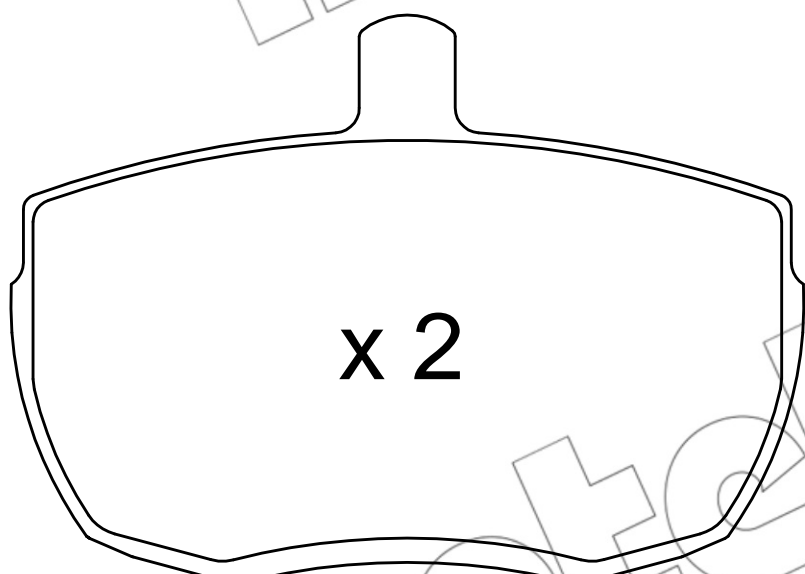

x 2

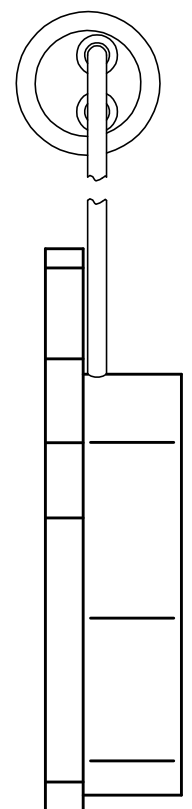
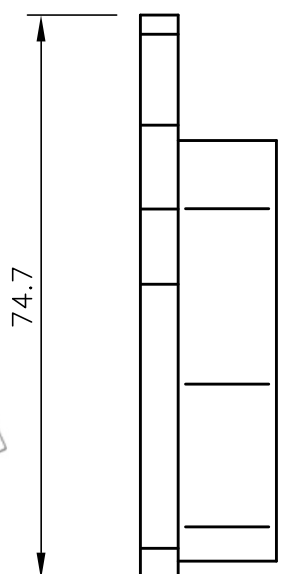

74.7

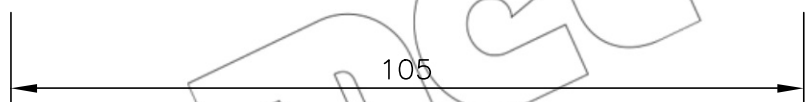

105

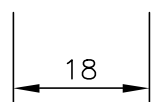

18