

- D** Elektroanlage für Anhängervorrichtung Montage- und Betriebsanleitung, Originalbetriebsanleitung
- CZ** Elektrické zařízení pro tažné zařízení Návod k montáži a použití
- DK** Elsæt til anhængertræk Monterings- og betjeningsvejledning
- E** Instalación eléctrica para el dispositivo de remolque Instrucciones de montaje y uso
- F** Installation électrique pour dispositif d'attelage Notice de montage et d'utilisation
- FIN** Vetolaitteen sähköjärjestelmä Asennus- ja käyttöohje
- GB** Electrical system for trailer hitch installation and operating manual
- GR** Ηλεκτρικό σύστημα για διάταξη ρυμούλκησης Οδηγίες τοποθέτησης και λειτουργίας
- HU** Elektromos felszerelés a vonószerkezet Szerelési- és üzemeltetési utasítások
- I** Impianto elettrico per gancio di traino Istruzioni di montaggio e per l'uso
- N** Elektrisk anlegg for tilhengerfeste Monterings- og bruksanvisning
- NL** Elektrische installaties voor aanhanger Montage- en gebruikshandleiding
- PL** Instalacja elektryczna do haka holowniczego Instrukcja montażu i obsługi
- RUS** Электрооборудование сцепки Инструкция по монтажу и эксплуатации
- S** Elsystem för dragkrok Monterings- och bruksanvisning

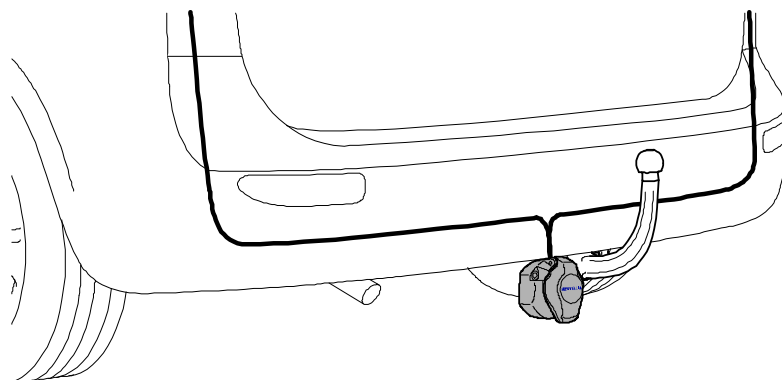

345 881 300 113

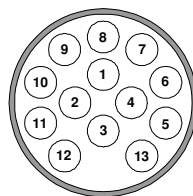

KIA Sorento

07/06 >> 09/09

KIT

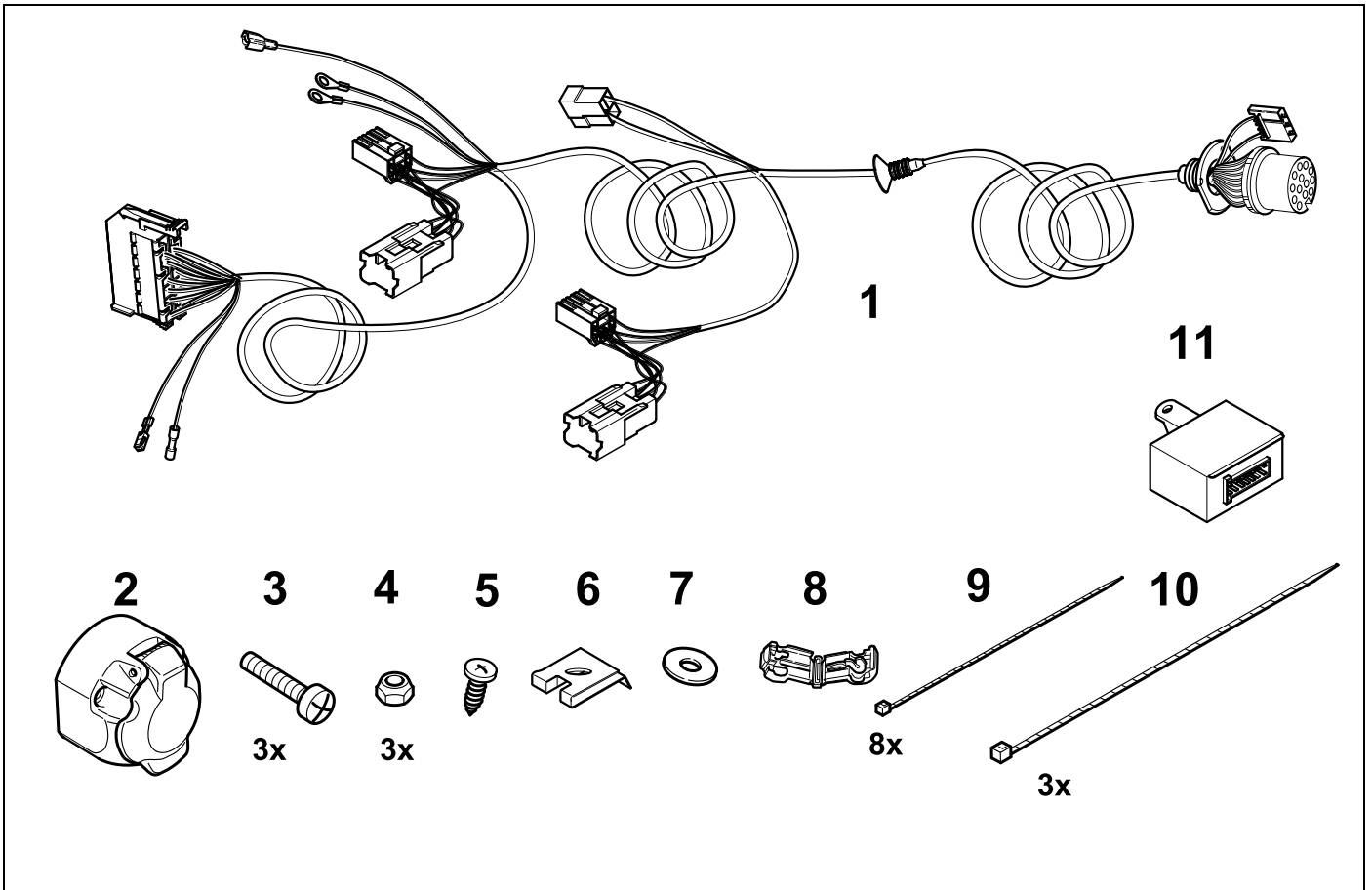

TOOLS

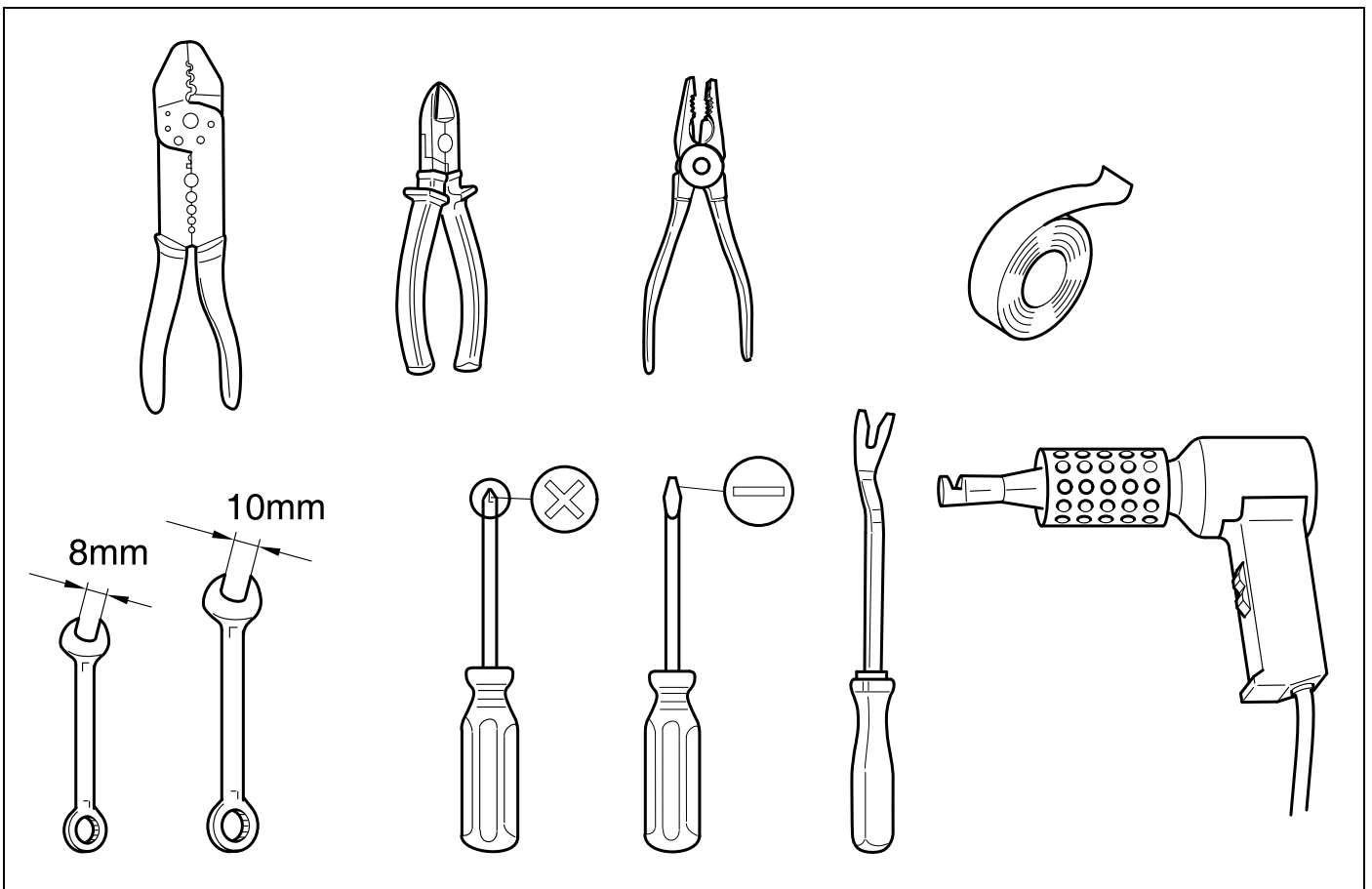

1

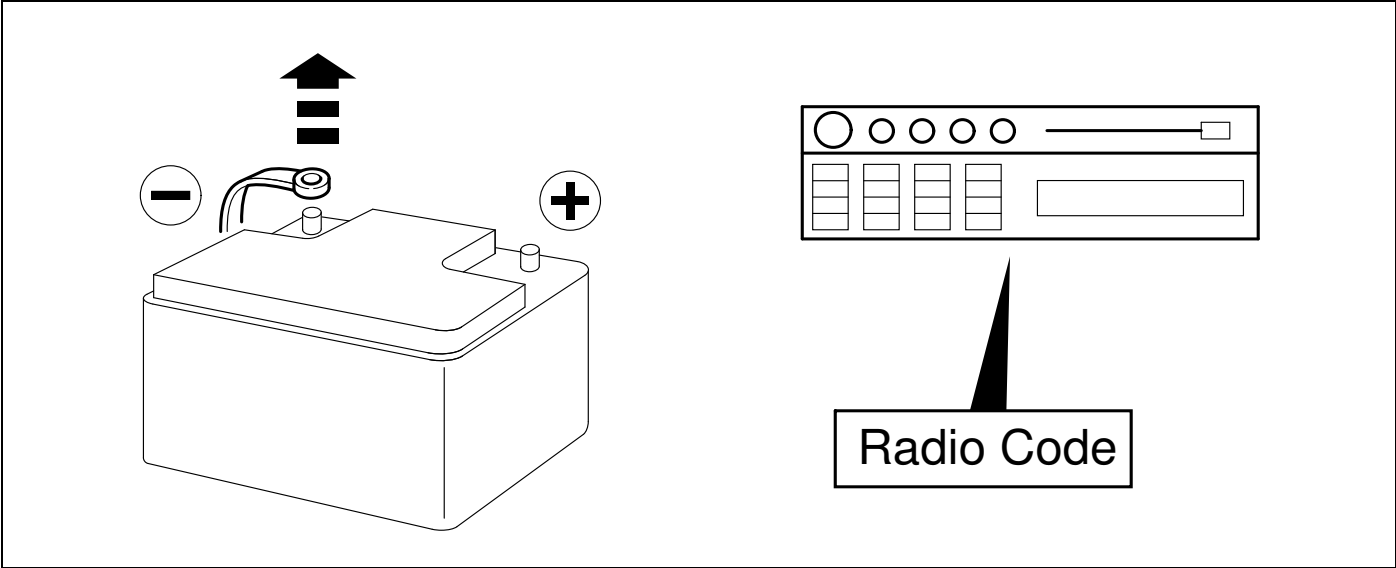

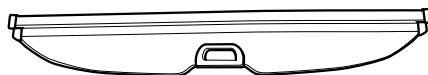
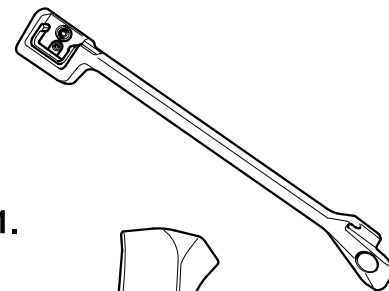
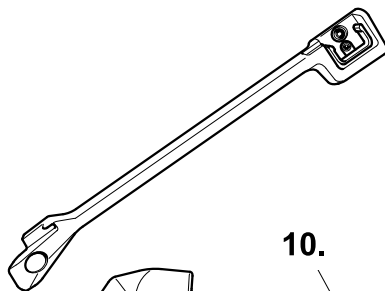
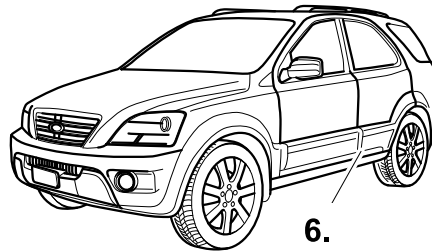
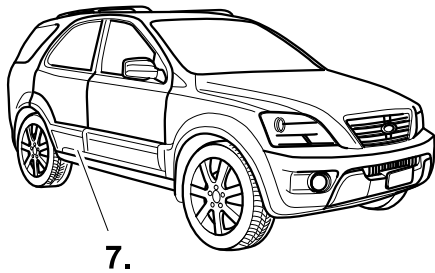

10.

11.

1.

9.

8.

4.

5.

13.

12.

3.

2.

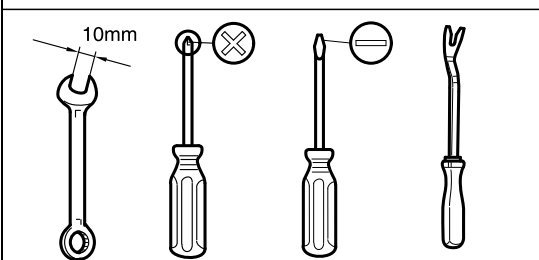
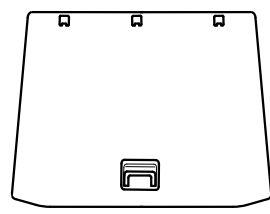
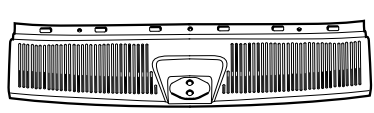
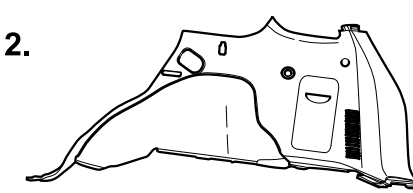
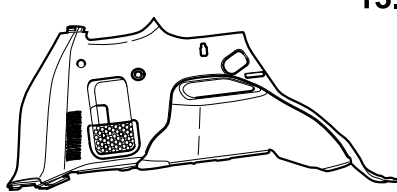
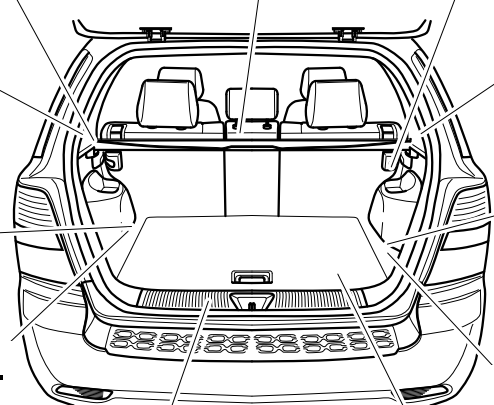
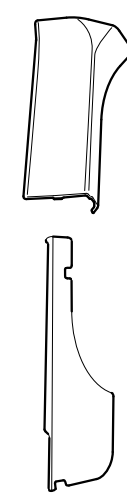
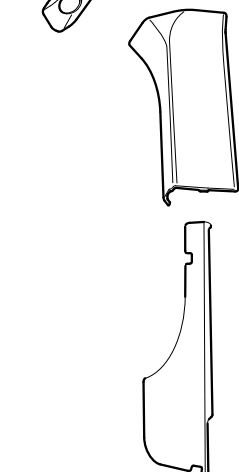

3

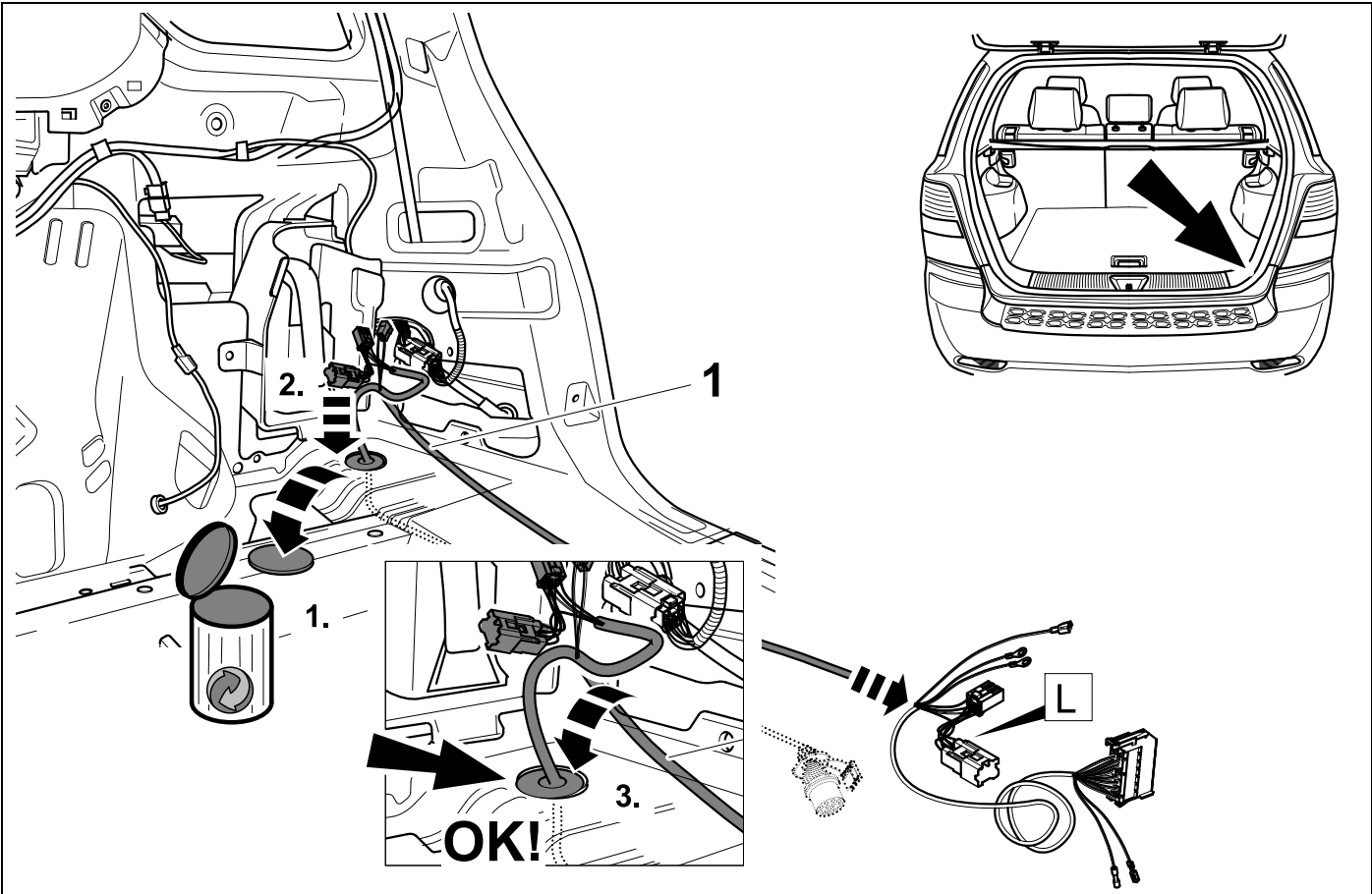

4

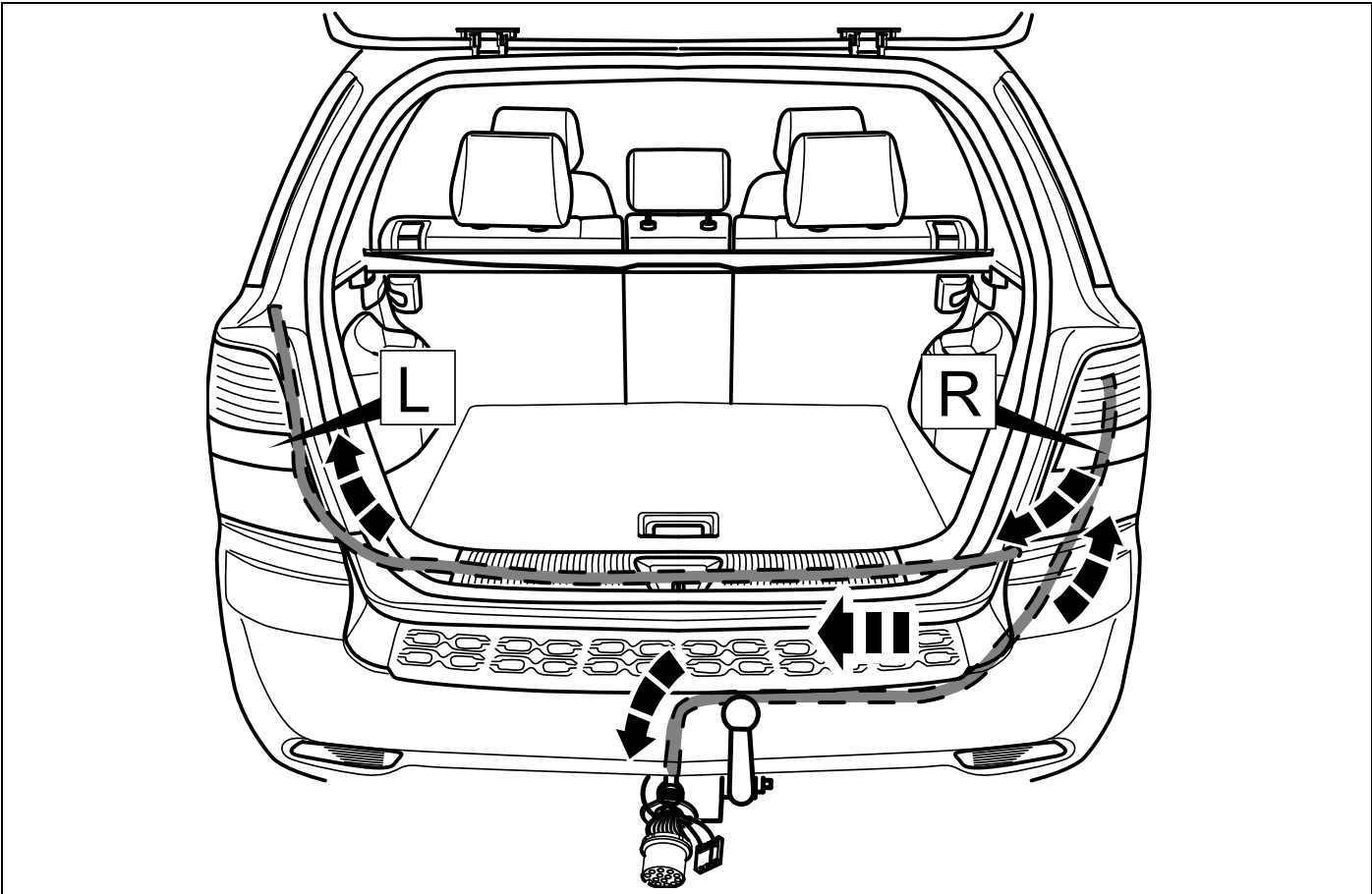

5



6

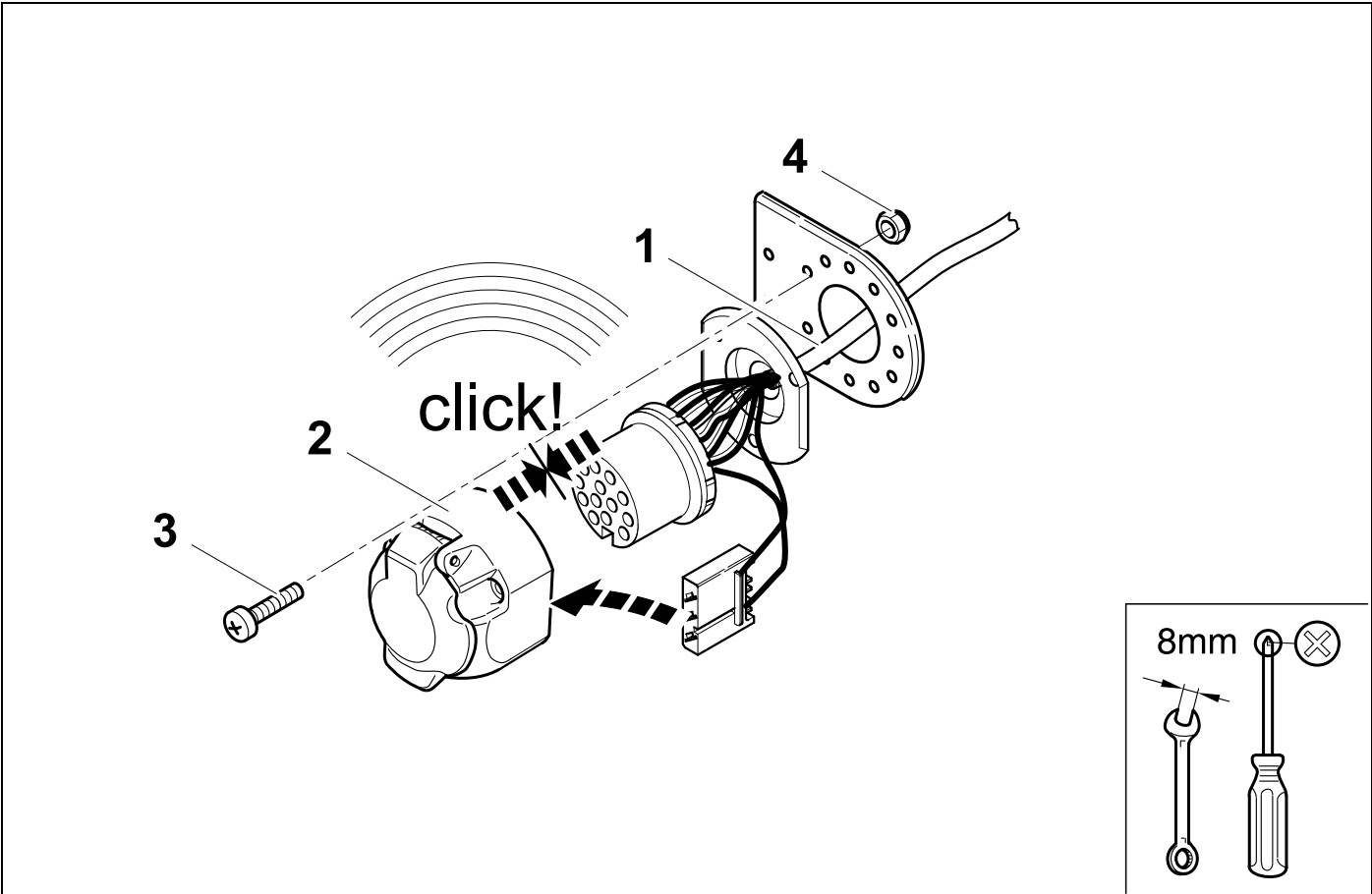

6



7

13 Pin

1	bk/wh		8	bu/rd	
2	gy		9	rd	
3	bn		10	no	
4	bk/gn		11	no	
5	gy/rd		12	no	
6	bk/rd		13	bn	
7	gy/bk				

7	bk	wh	gy	gn	rd	bu	ye	bn	pu	or	no
D	schwarz	weiss	grau	grün	rot	blau	gelb	braun	violett	orange	nicht belegt
CZ	černý	bílý	šedý	zelený	červený	modrý	žlutý	hnědý	fialový	oranžový	neobsazen
DK	sort	hvid	grå	grøn	rød	blå	gul	brun	violet	orange	ikke anvendt
E	negro	blanco	gris	verde	rojo	azul	amarillo	marrón	violeta	anaranjado	no ocupado
F	noir	blanc	gris	vert	rouge	bleu	jaune	brun	violet	orange	inutilisé
FIN	musta	valkoinen	harmaa	vihreä	punainen	sininen	keltainen	ruskea	violetti	oranssi	ei varattu
GB	black	white	grey	green	red	blue	yellow	brown	purple	orange	not occupied
GR	μαύρος	λευκός	Γκρι	πράσινος	κόκκινος	μπλε	κίτρινος	καφέ	Μωβ	πορτοκαλί	δεν είναι κατειλημμένος
HU	fekete	fehér	szürke	zöld	piros	kék	sárga	barna	ibolyakék	narancssárga	nem foglalt
I	nero	bianco	grigio	verde	rosso	blu	giallo	marrone	viola	arancione	libero
N	svart	hvit	grå	grønn	rød	blå	gul	brun	fiolett	oransje	ikke i bruk
NL	zwart	wit	grijs	groen	rood	blauw	geel	bruin	violet	oranje	niet aangesloten
PL	czarny	biały	szaro	zielony	czerwony	niebiesko	żółty	brazowy	fioletowy	pomarańczowy	wolny
RUS	черный	белый	серый	зеленый	красный	голубой	желтый	коричневый	пурпурный	оранжевый	свободно
S	svart	vit	grå	grön	röd	blå	gul	brun	violett	orange	ej använd

8

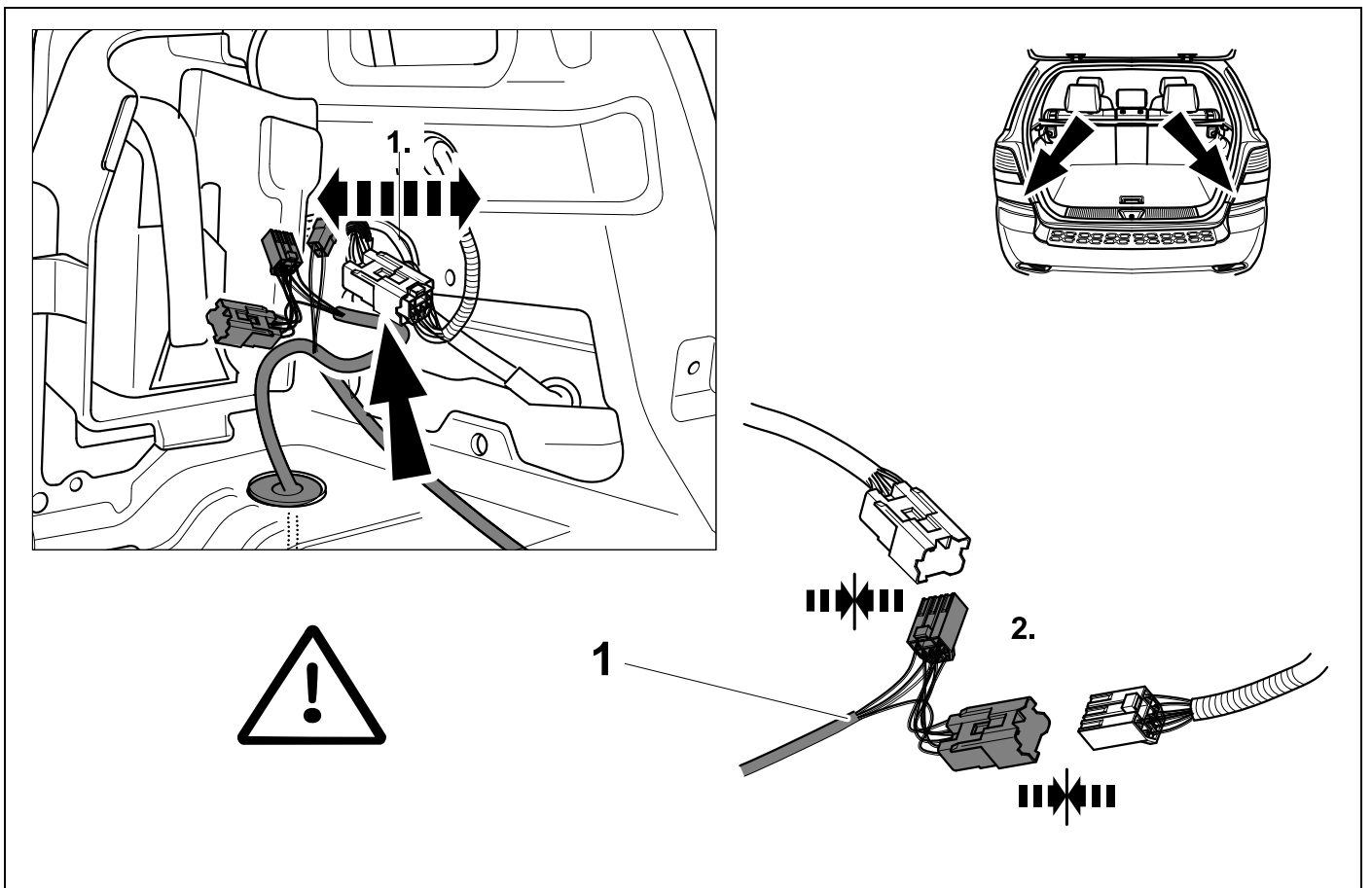

9

👁️ ⇒ 7

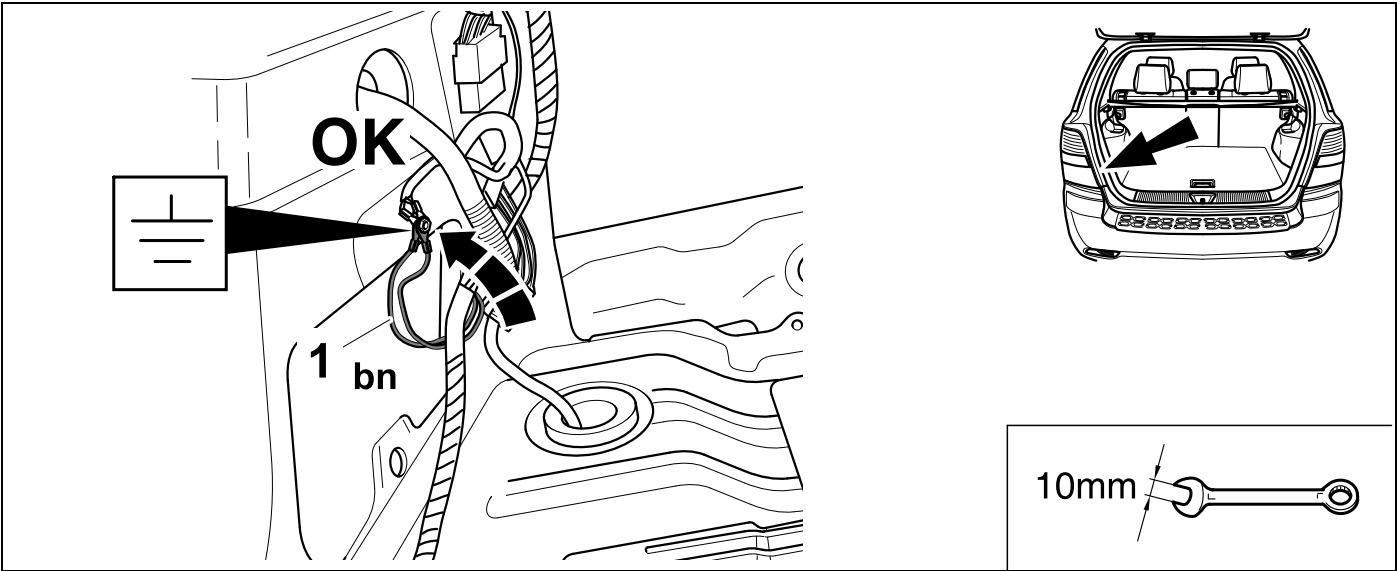

10

👁️ ⇒ 7

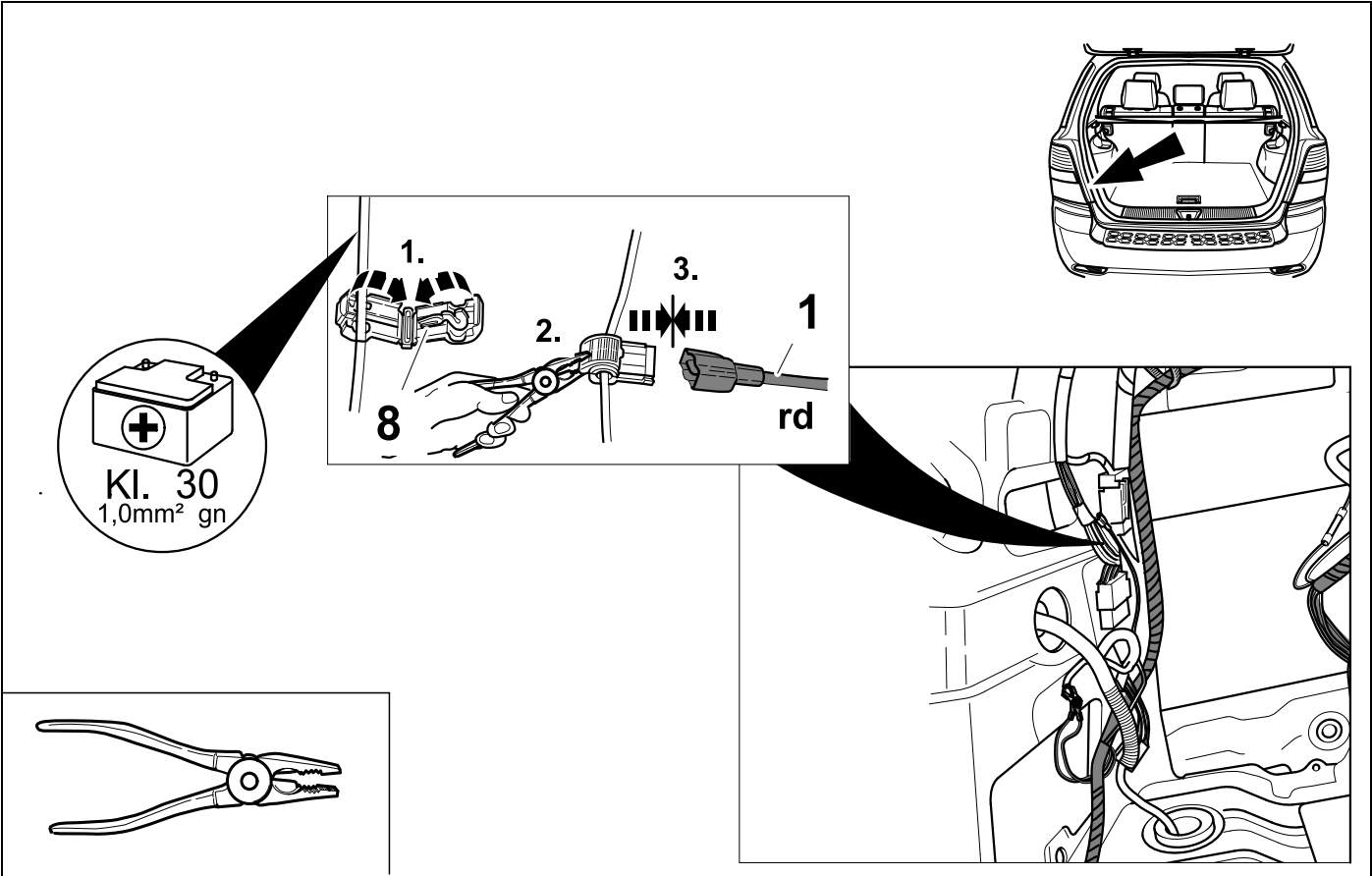

11

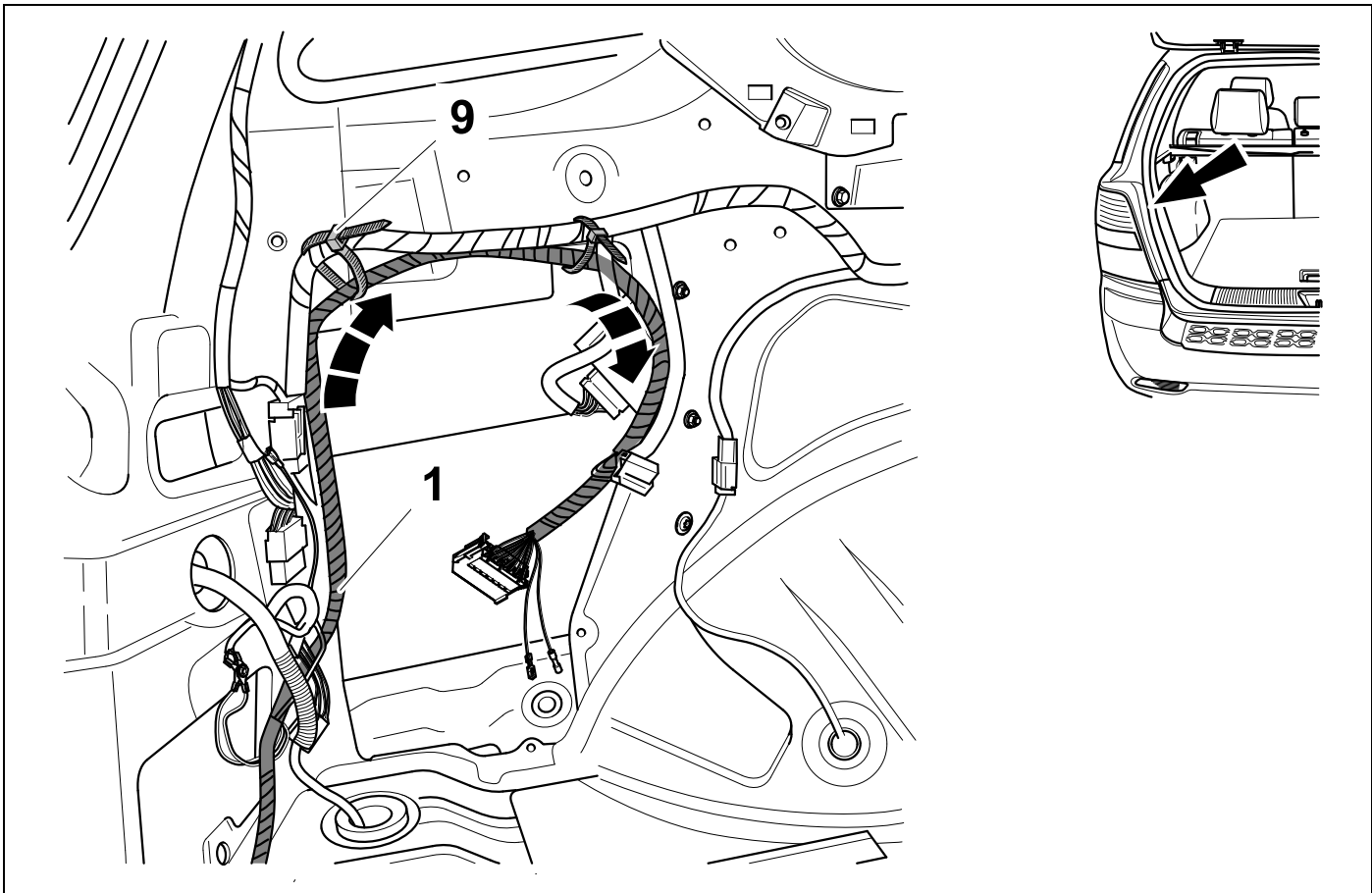

12

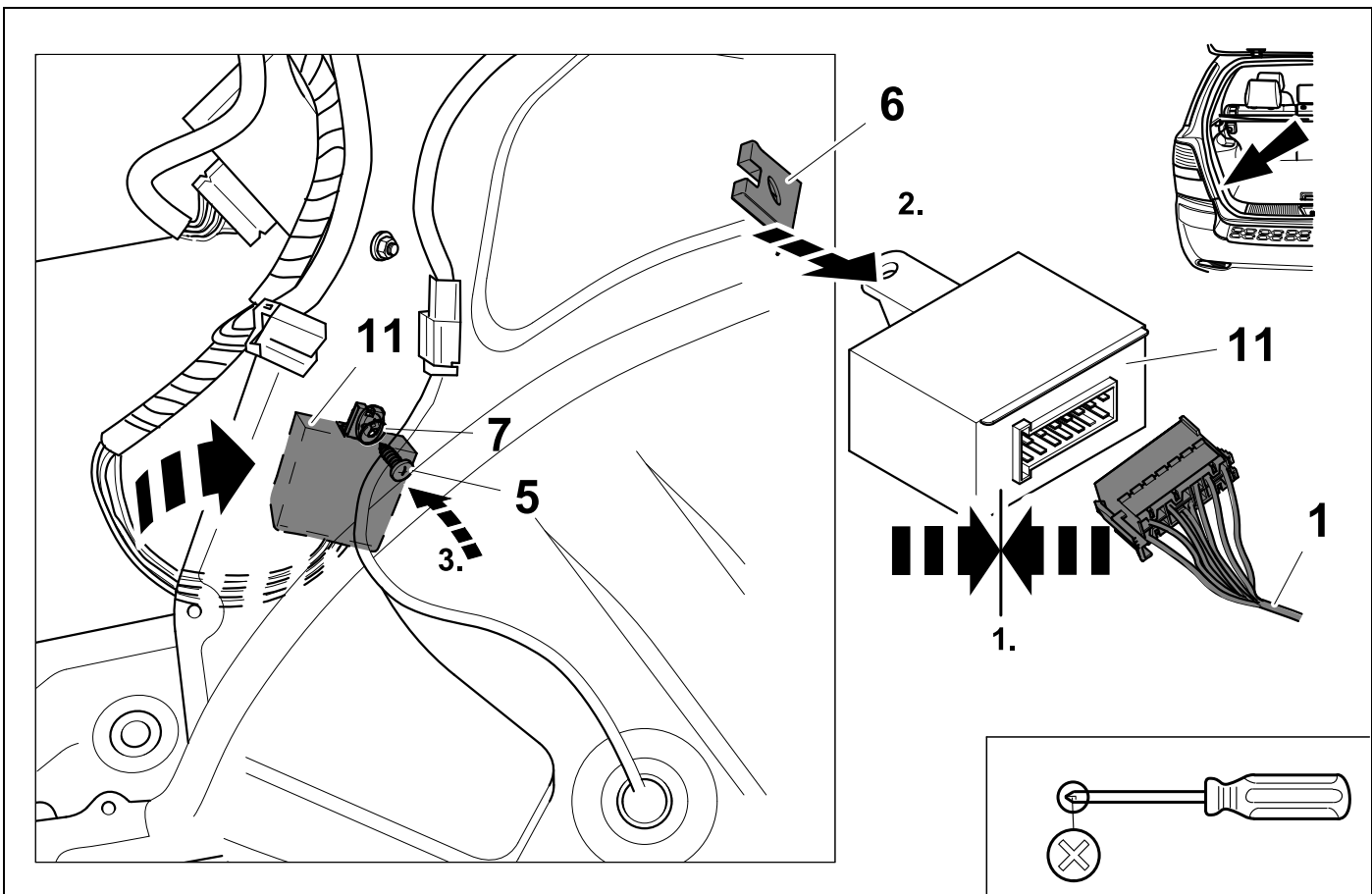

13

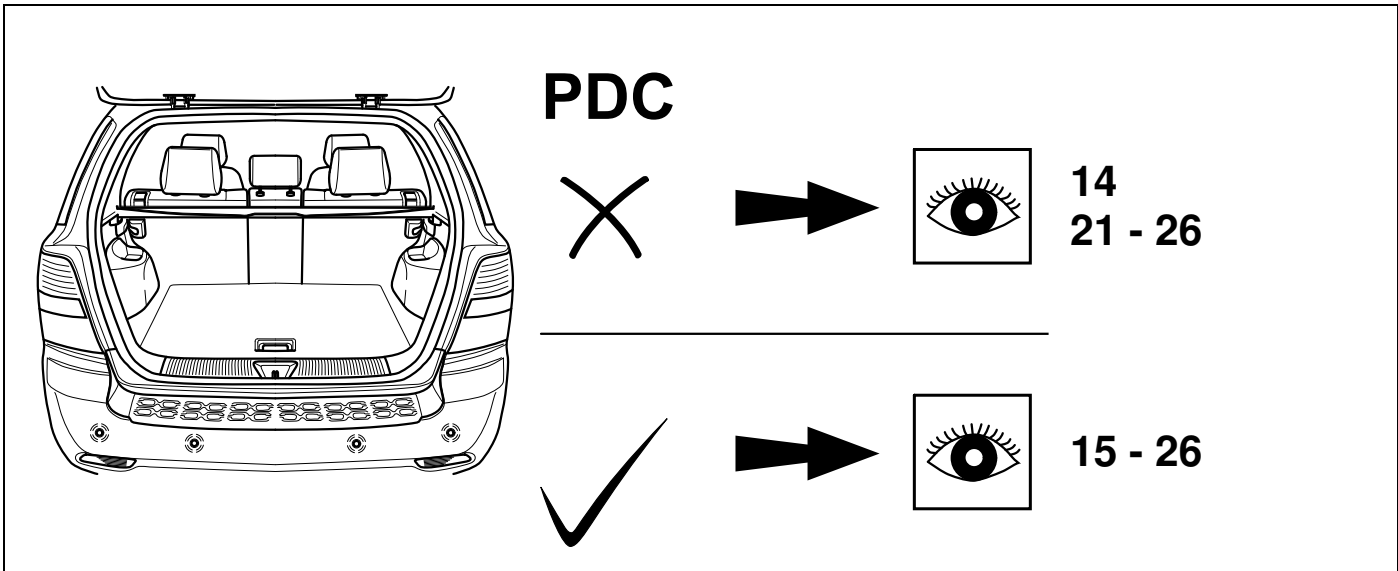

14

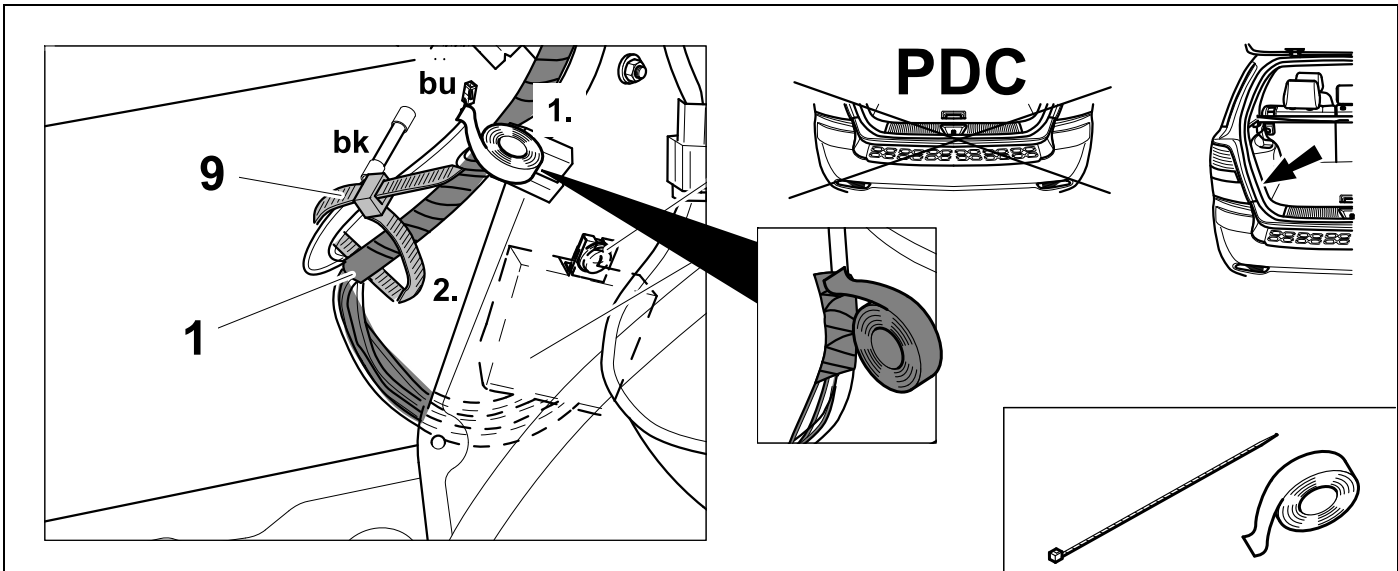

15

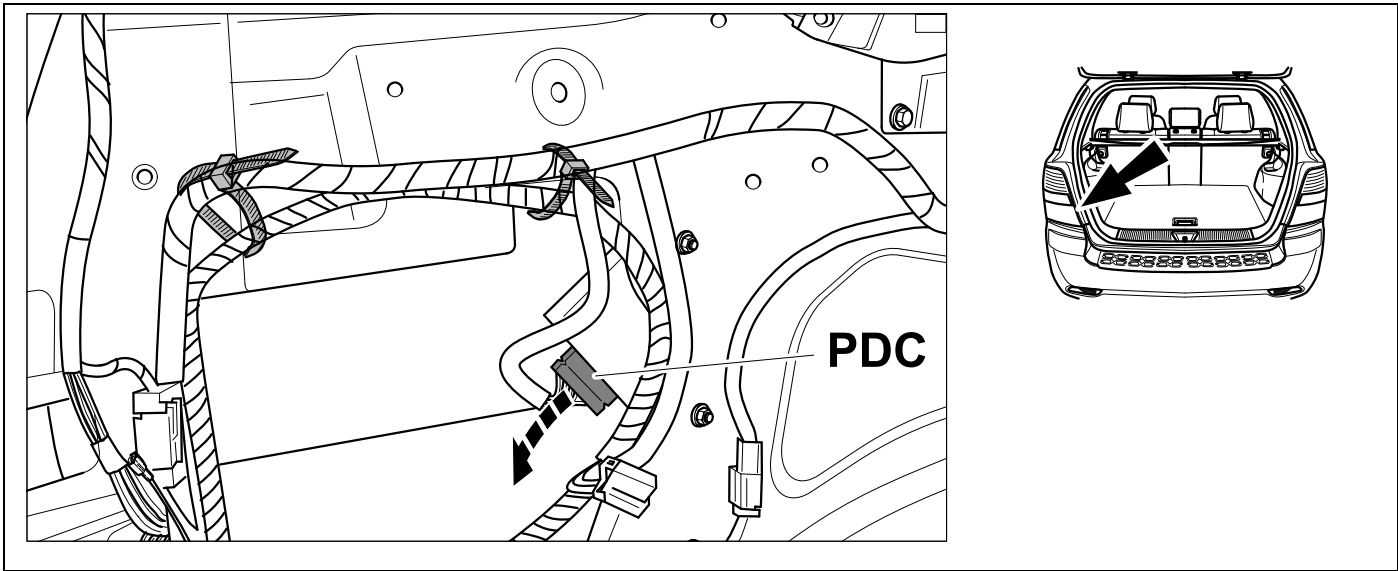

16



7

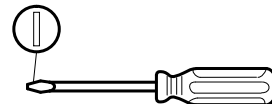
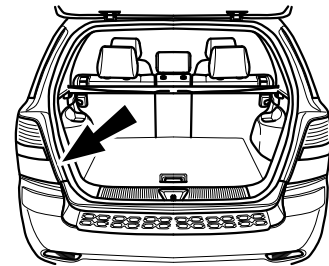
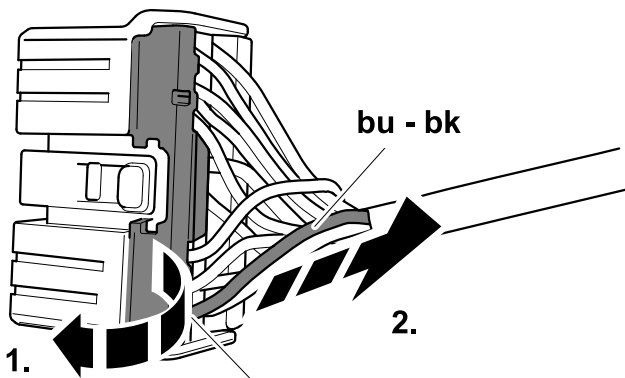

17



7

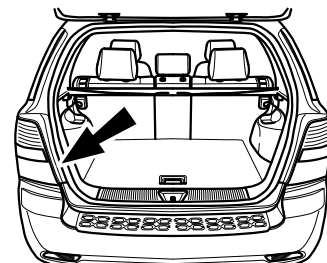
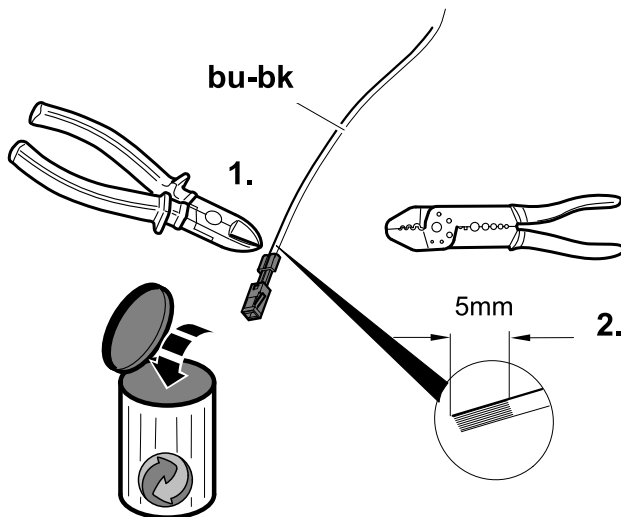

18



7

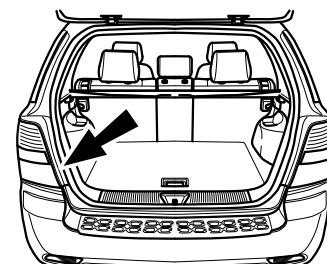
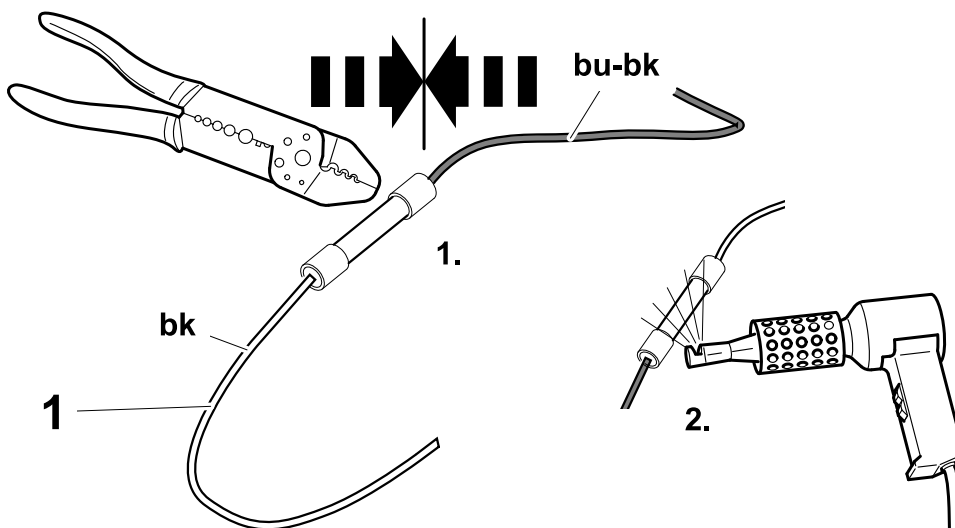

19



7

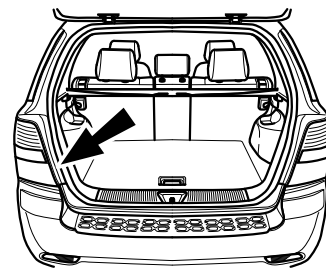
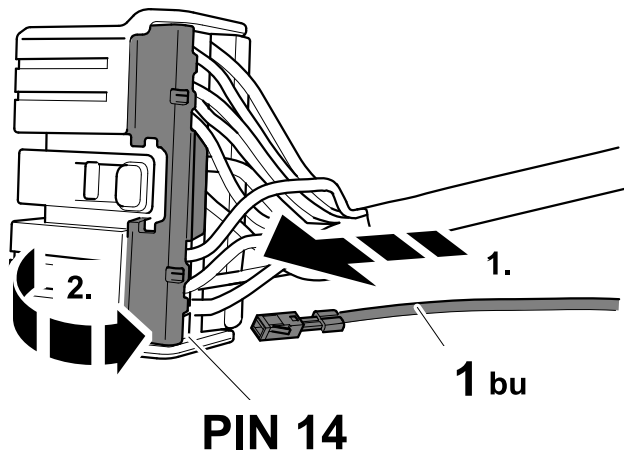

20

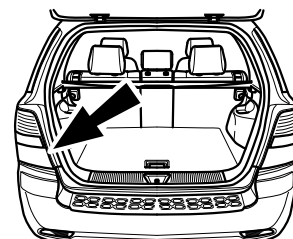
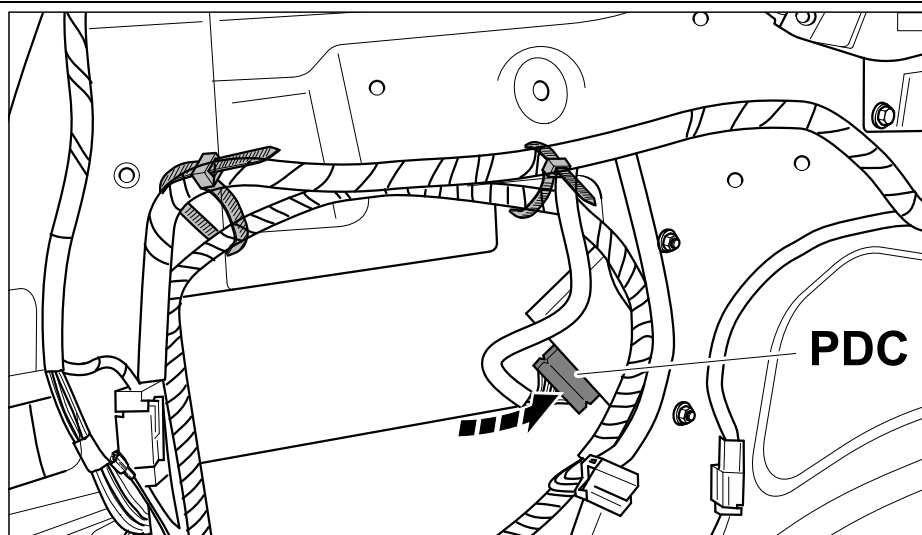

21

pin 9

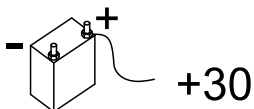

pin 13

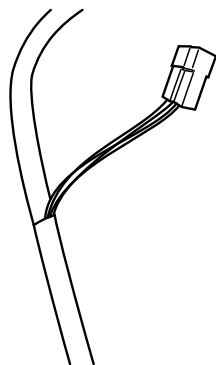

pin 9 - + +30

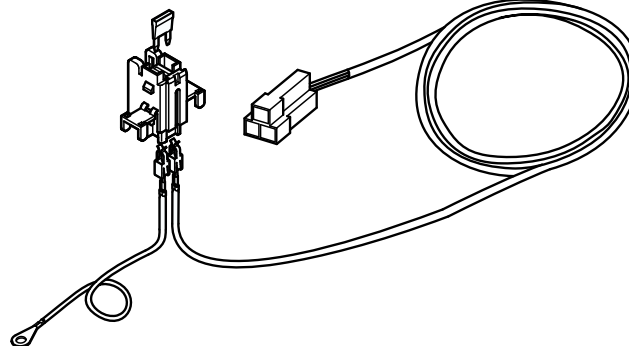

WA no.: 300 027 300 113

22

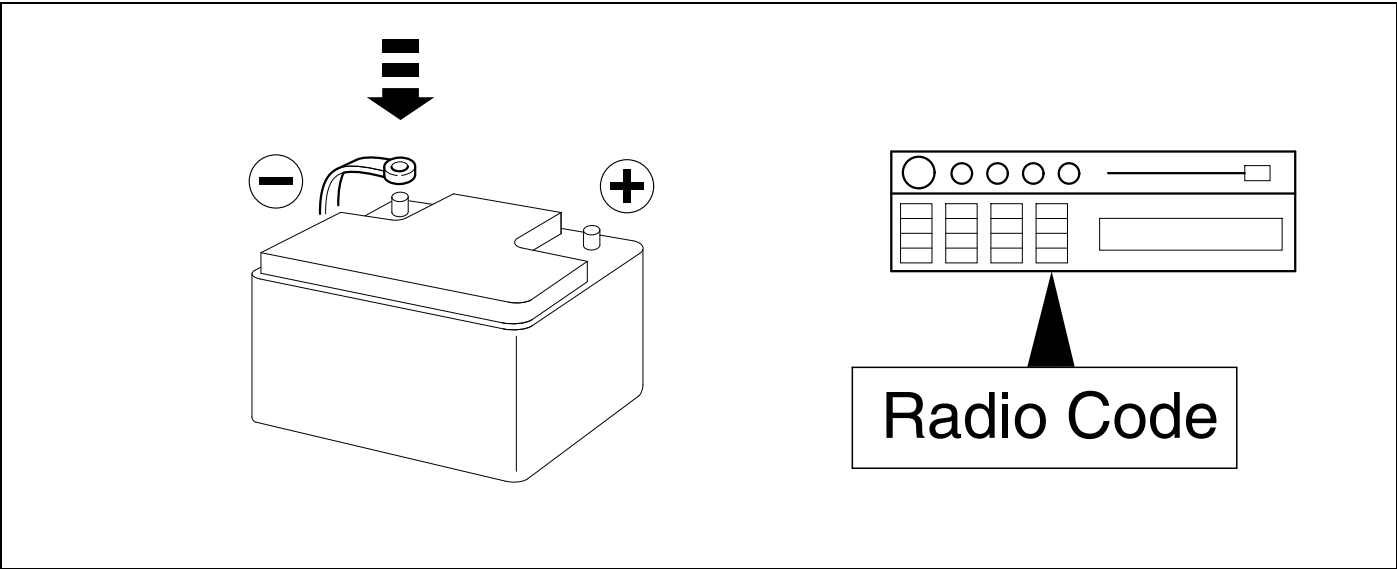

23

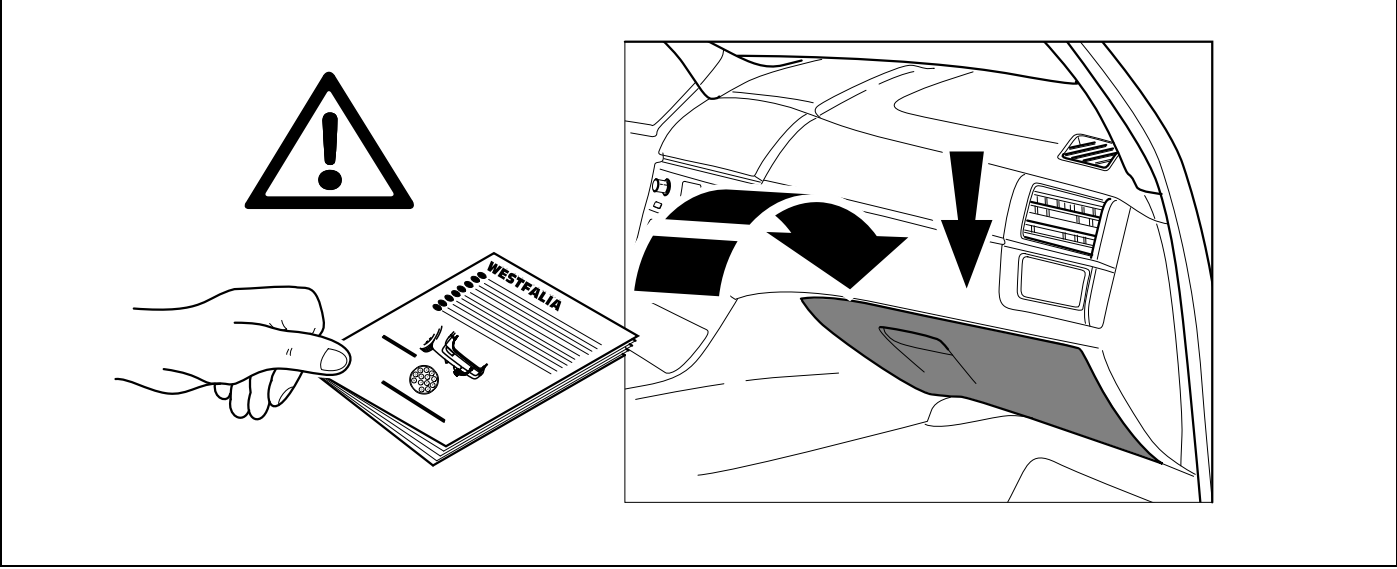

24

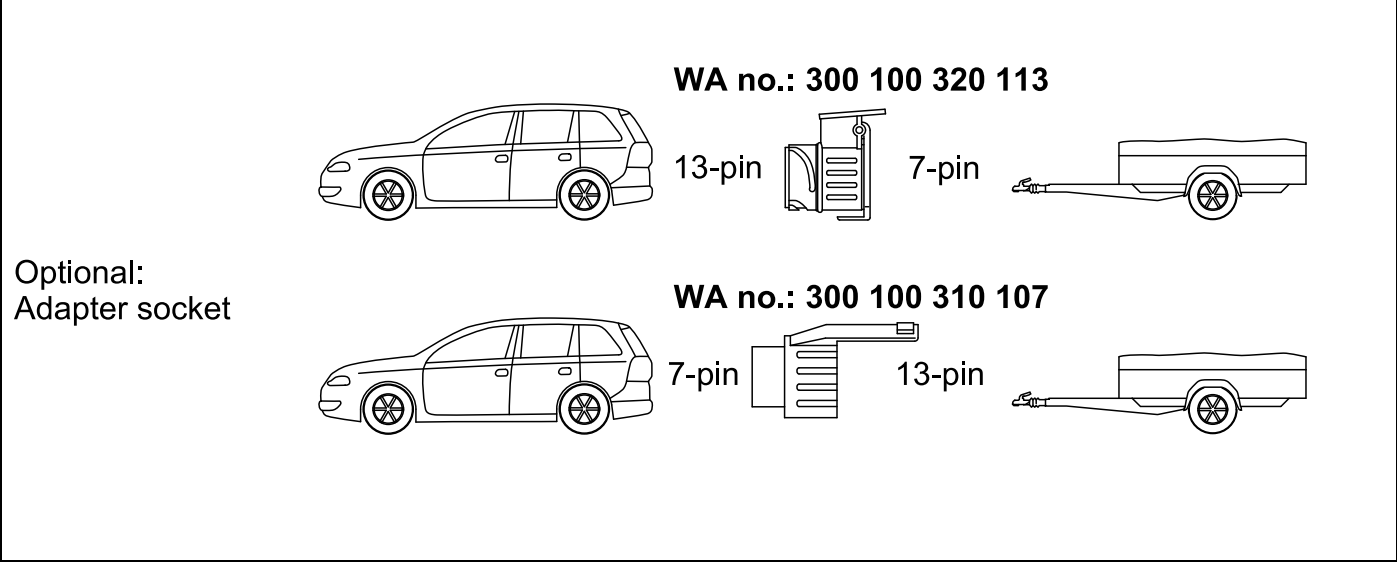

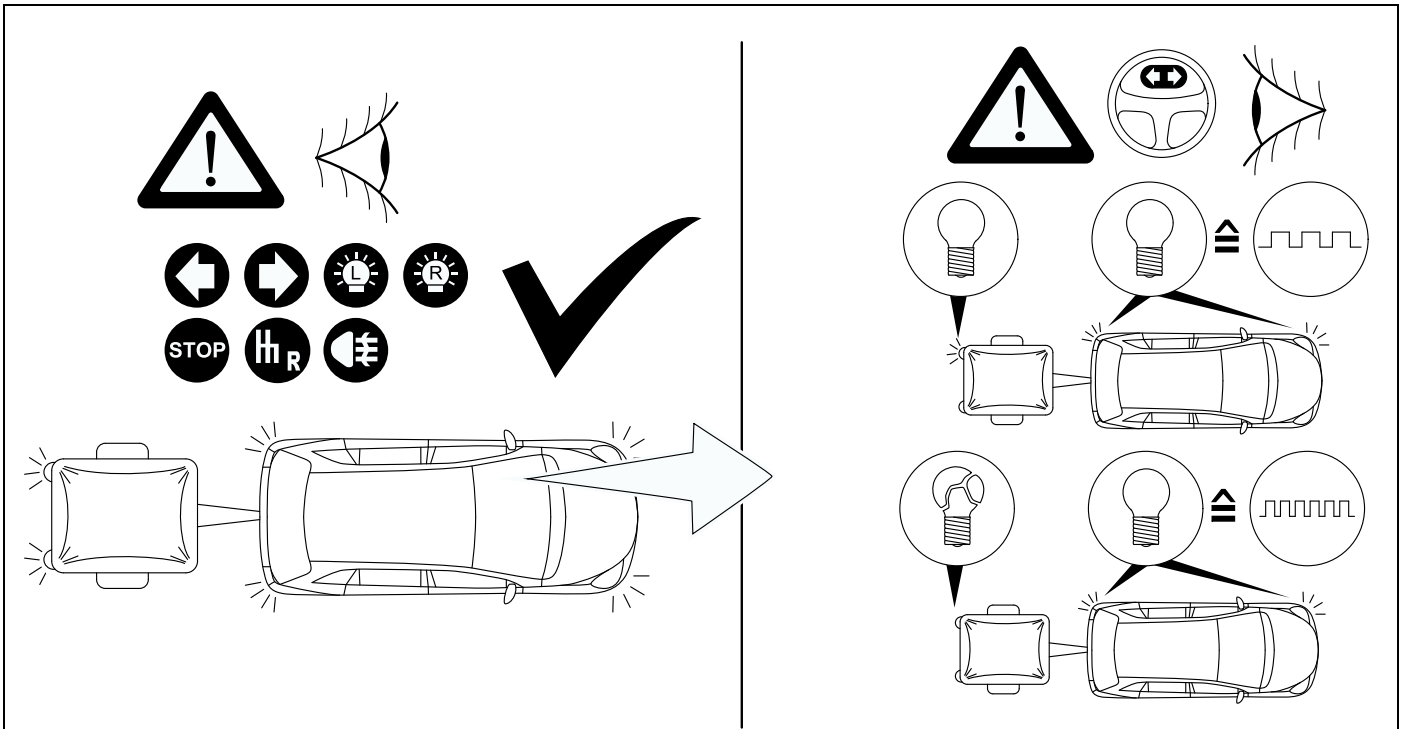

WESTFALIA

Trailer simulation for carcheck 7-pin and 13-pin

WA no.: 900 001 300 199

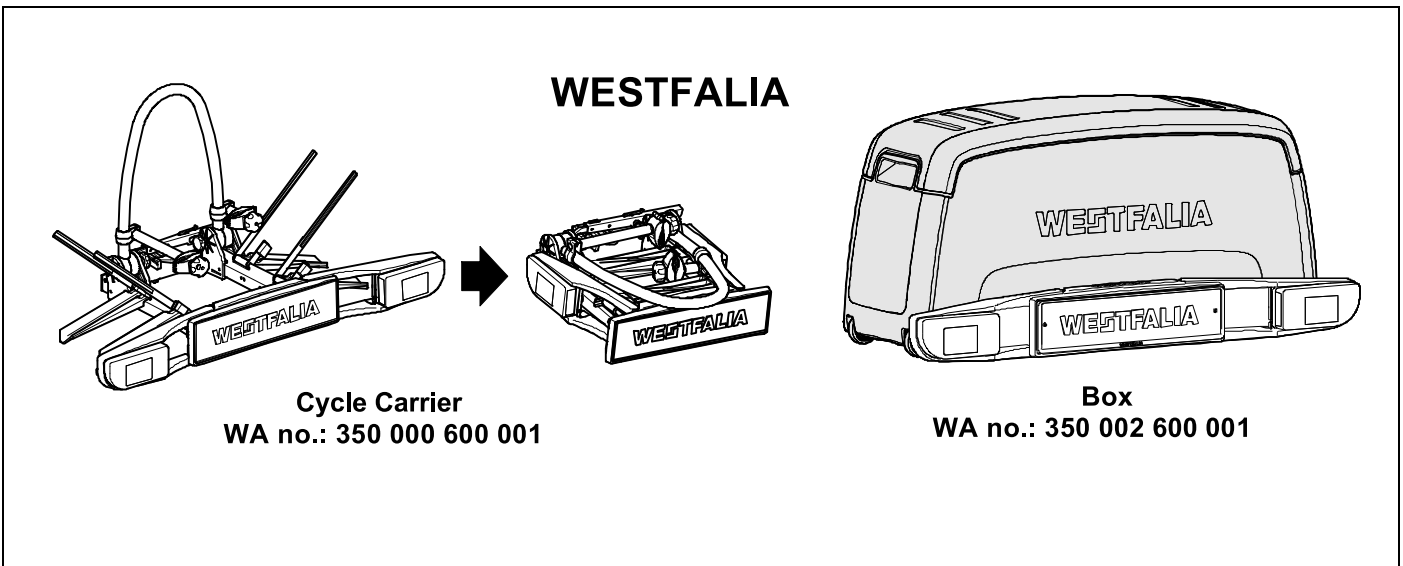
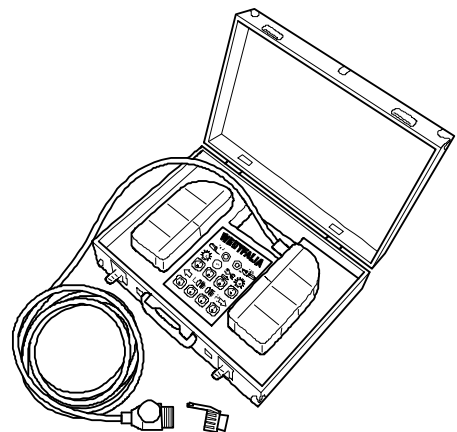

WESTFALIA

Cycle Carrier

WA no.: 350 000 600 001

Box

WA no.: 350 002 600 001

- D** Änderungen bezüglich Konstruktion, Ausstattung Farbe sowie Irrtum vorbehalten.
Angaben und Abbildungen unverbindlich
- CZ** Změny, týkající se konstrukce, vybavení, barvy, jakož i omyly jsou vyhrazeny.
Údaje a vyobrazení jsou nezávazné.
- DK** Ændringer med hensyn til konstruktion, udstyr, farver samt fejl forbeholdes.
Oplysninger og illustrationer er uforpligtende.
- E** Reservadas las modificaciones respecto a diseño, equipamiento, color, así como error. Indicaciones y figuras sin compromiso.
- F** Sous réserve de modifications de la construction, de équipement, de la couleur et sous réserve d'erreurs. Les indications et les illustrations sont sans engagement.
- FIN** Pidätämme oikeuden rakennetta, varustusta, väriä koskeviin sekä erehdyksestä johtuviin muutoksiin. Tiedot ja kuvat eivät ole sitovia.
- GB** Subject to change in terms of construction, equipment and colour, and may contain errors.
The information and illustrations are non-binding.
- GR** Διατηρώνουμε κάθε επιφύλαξη ως προς αλλαγές σε σχέση με κατασκευή, εξοπλισμό, διαρρύθμιση, χρωματισμούς και λάθη παραδρομής.
- HU** A szerkezet, a kivitelt és a szín változtatása, valamint a változások joga fenntartva.
Az adatok és az ábrák nem kötelező érvényűek.
- I** Con riserva di modifiche relative a progettazione, dotazione, colore ed errori.
Le indicazioni e figure sono fornite senza impegno.
- N** Endringer angående konstruksjon, utstyr, farge og feiltagelse forbeholdes.
Opplysninger og illustrasjoner uforbindtlig.
- NL** Wijzigingen met betrekking tot constructie, uitvoering en kleur evenals vergissingen voorbehouden. Gegevens en afbeeldingen niet bindend.
- PL** Zastrzega się prawo do zmian dot. konstrukcji, wykończenia, kolorystyki oraz pomyłek.
Dane i ilustracje niewiążące.
- RUS** Права на внесение изменений относительно конструкции, оснащения, окраски, а также на ошибки сохраняются. Данные и иллюстрации имеют примерный характер.
- S** Med reservation för ändringar vad det gäller konstruktion, utrustning, färg samt för misstag. Uppgifterna och bilderna är inte bindande.