

- D** **Elektroanlage für Anhängervorrichtung** Montage- und Betriebsanleitung, Originalbetriebsanleitung
- CZ** **Elektrické zařizení pro tažné zařizení** Montážní a provozní návod
- DK** **Elsæt til anhængertræk** Montage- og driftsvejledning
- E** **Instalación eléctrica para el dispositivo de remolque** Instrucciones de montaje y de servicio
- F** **Installation électrique pour dispositif d'attelage** Notice de montage et d'utilisation
- FIN** **Vetolaitteen sähköjärjestelmä** Asennus- ja käyttöohjeet
- GB** **Electrical system for trailer hitch** Installation and Operating Instructions
- GR** **Ηλεκτρικό σύστημα για διάταξη ρυμούλκησης** Οδηγίες συναρμολόγησης και λειτουργίας
- H** **Elektromos felszerelés a vonószerkezet** Beszerelési utasítás
- I** **Impianto elettrico per gancio di traino** Istruzioni di montaggio e per l'uso
- N** **Elektrisk anlegg for tilhengerfeste** Monterings- og bruksanvisning
- NL** **Elektrische installaties voor aanhanger** Montage- en gebruikshandleiding
- PL** **Instalacja elektryczna do haka holowniczego** Instrukcja montażu i eksploatacji
- RUS** **Электрооборудование для фаркопа** Инструкция по монтажу и эксплуатации
- S** **Elsystem för dragkrok** Monterings- och bruksanvisning

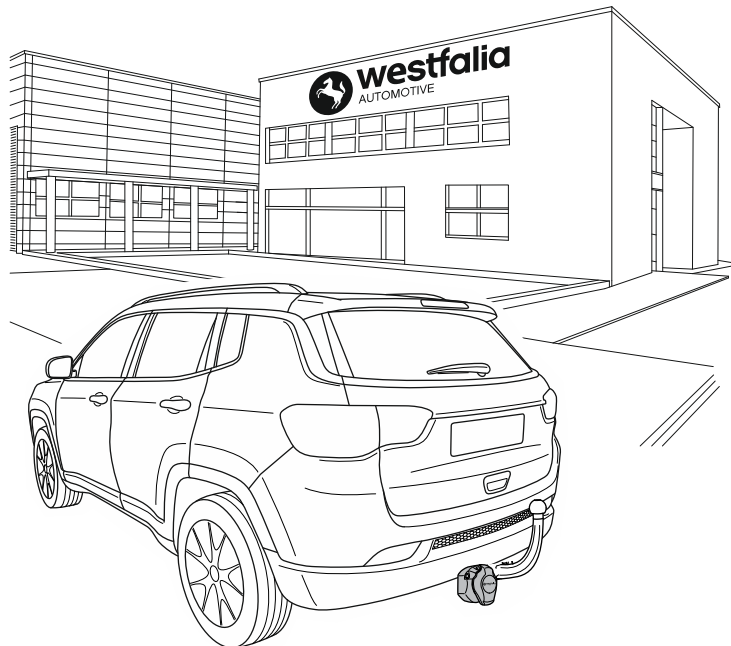

**342 265 300 113**

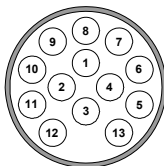

**Jeep Compass, 08/2017 →**

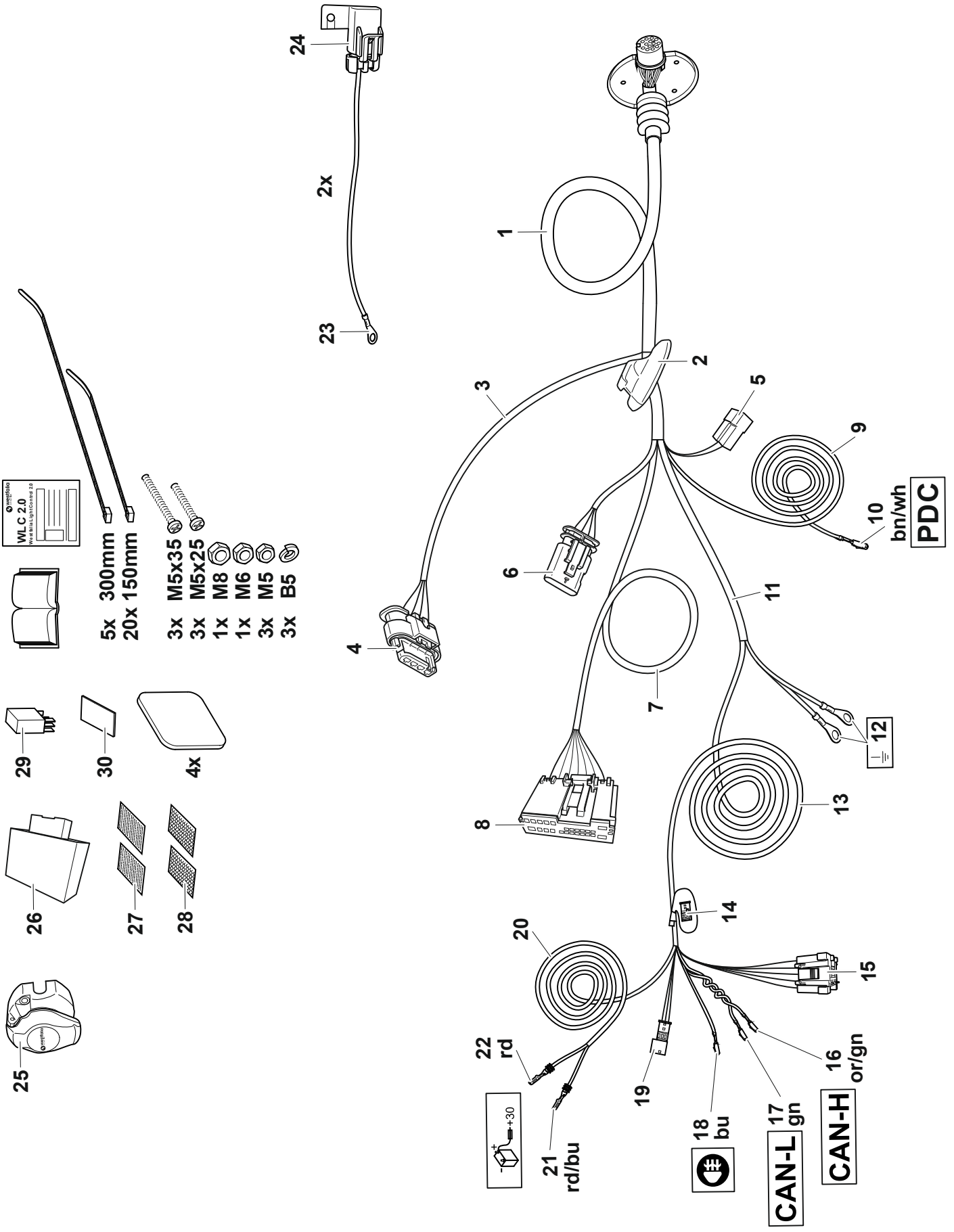

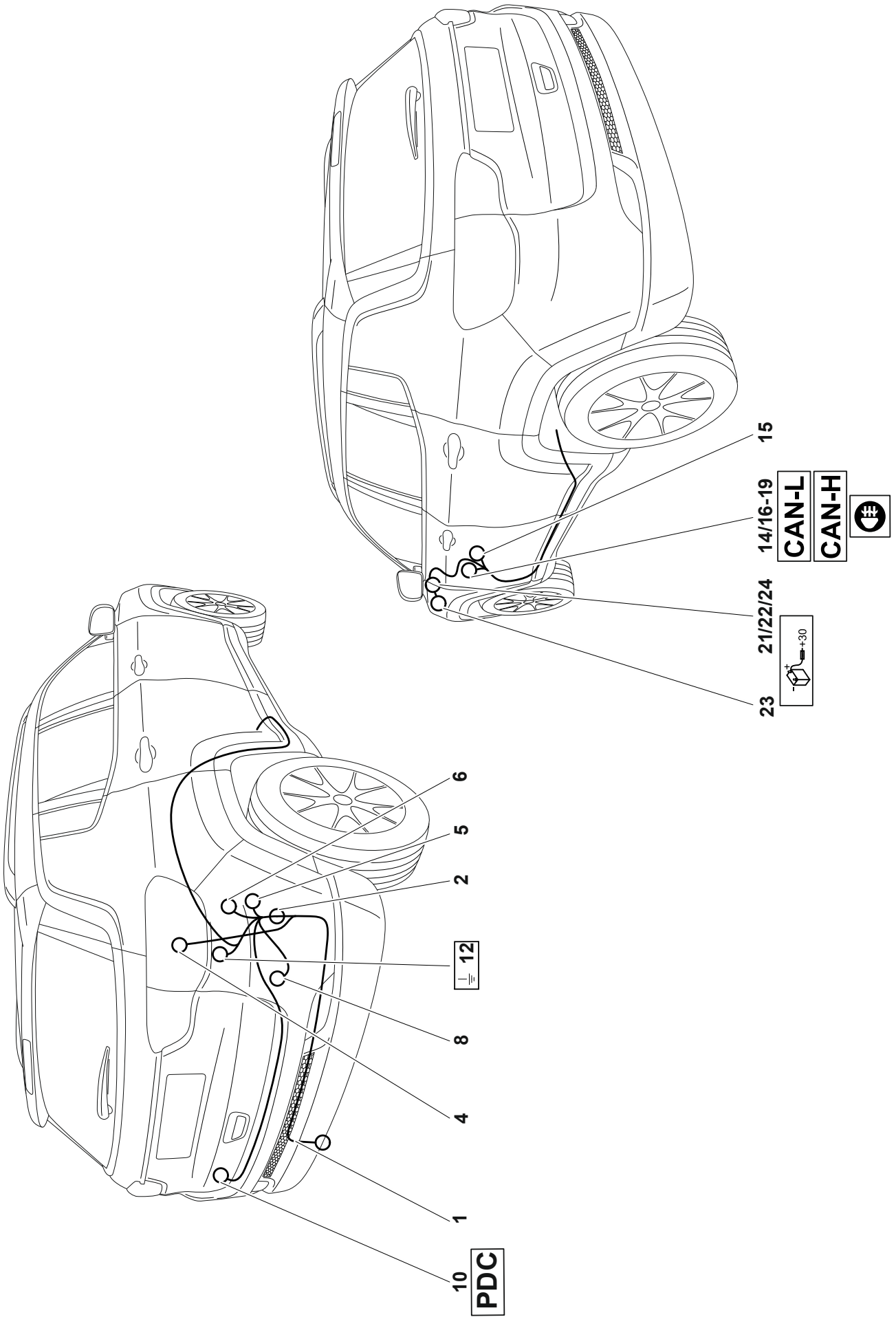



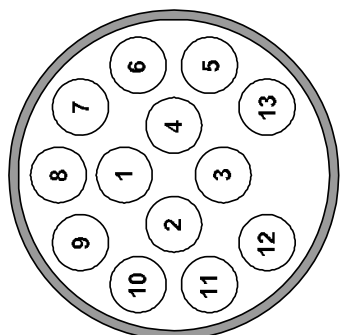











- D** Steckdosenbelegung
- E** Esquema de tomas de enchufe
- GB** Pin assignment
- I** Schema dei collegamenti della presa
- PL** Rozkład pinów
- CZ** Obsazení zásuvky
- F** Affectation des prises électriques
- GR** Αντιστοιχία πρίζας
- N** Kontaktskjema
- RUS** Разводка розеток
- DK** Koblingsschema
- FIN** Pistorasian navat
- H** Csatlakozódugó leosztása
- NL** Contactdoosbezetting
- S** Stickdosschema



















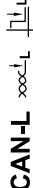





ISO 11446

	<b>S</b>	<b>RUS</b>	<b>PL</b>	<b>NL</b>	<b>N</b>	<b>I</b>	<b>H</b>	<b>GR</b>	<b>GB</b>	<b>FIN</b>	<b>F</b>	<b>E</b>	<b>DK</b>	<b>CZ</b>	<b>D</b>	Leistung / Power			
1 (L)	svart/ vit	черный/ белый	czarno/ biały	zwart/ wit	svart/ hvit	nero/ bianco	fekete/fehér	μαύρο/ λευκό	black/ white	musta/valkoinen	noir/ blanc	negro/ blanco	sort/hvid	černobílá	schwarz/ weiß	21 W	↓		
2 (54g)	vit	белый	biały	wit	hvit	bianco	fehér	λευκό	white	valkoinen	bianc	blanco	hvid	bílá	weiß	Min. 21 W Max. 42 W			
3 (31)	svart	черный	czarno	zwart	svart	nero	fekete	μαύρο	black	musta	noir	negro	sort	černo	schwarz		⏏ (1-8)		
4 (R)	svart/ grön	черный/ зеленый	czarno/ zielony	zwart/ groen	svart/ grønn	nero/ verde	fekete/zöld	μαύρο/ πράσινο	black/ green	musta/vihreä	noir/vert	negro/ verde	sort/grøn	černo/ zelená	schwarz/ grün	21 W	↑		
5 (58R)	grå/ rødt	серый/красный	szaro/ czerwony	grijs/ rood	grå/rød	grigio/ rosso	szürke/piros	γκρι/ κόκκινο	gray/ red	harmaa/punainen	gris/ rouge	gris/rojo	grå/rød	šedočervená	grau/rot				
6 (54)	svart/ rødt	черный/ красный	czarno/ czerwony	zwart/ rood	svart/ rød	nero/ rosso	fekete/piros	μαύρο/ κόκκινο	black/ red	musta/punainen	noir/ rouge	negro/ rojo	sort/rød	černo/ červená	schwarz/ rot				
7 (58L)	grå/ svart	серый/черный	szaro/ czarny	grijs/ zwart	grå/ svart	grigio/ nero	szürke/kete	γκρι/ μαύρο	gray/ black	harmaa/ musta	gris/ noir	gris/ negro	grå/sort	šedočerná	grau/schwarz				
8	grön	зеленый	zielony	groen	grønn	verde	zöld	πράσινο	Green	vihreä	vert	verde	grøn	zelená	grün				
9 (+30)	rødt	красный	czernony	rood	rød	rosso	piros	κόκκινο	red	punainen	rouge	rojo	rød	červená	rot				
10 (+15)	gul	желтый	zółty	geel	gul	giallo	sárga	κίτρινο	yellow	keltainen	jaune	amarillo	gul	žlutá	gelb				
11 (31)	Svart/ gul	Черный/ желтый	Czarno/ zółty	Zwart/ geel	Svart/ gul	Nero/ giallo	Fekete/ sárga	Μαύρο/ κίτρινο	Black/ yellow	Musta/ keltainen	Noir/ jaune	Negro/ amarillo	Sort/ gul	Černo/ žlutá	schwarz/ gelb		⏏ (10)		
12	--	--	--	--	--	--	--	--	--	--	--	--	--	--	--				
13 (31)	svart	черный	czarno	zwart	svart	nero	fekete	μαύρο	black	musta	noir	negro	sort	černo	schwarz				

	dark	light	bk	wh	bn	gn	gy	rd	ye	bu	or	pu	pi
<b>D</b>	dunkel	hell	schwarz	weiß	braun	grün	grau	rot	gelb	blau	orange	violett	rosa
<b>CZ</b>	tmový	bystrý	černo	bílá	hnědá	zelená	šedo	červená	žlutá	modrý	oranžový	fialový	růžová
<b>DK</b>	mørk	lyse	sort	hvid	brun	grøn	grå	rød	gul	blå	orange	violet	rosa
<b>E</b>	oscuro	claro	negro	blanco	marrón	verde	gris	rojo	amarillo	azul	anaranja-do	violeta	rosa
<b>F</b>	foncé	clair	noir	blanc	marron	vert	gris	rouge	jaune	bleu	orange	violet	rose
<b>FIN</b>	tumma	kirkas	musta	valkoinen	ruskea	vihreä	harmaa	punainen	keltainen	sininen	oranssi	violetti	rosa
<b>GB</b>	dark	light	black	white	brown	green	grey	red	yellow	blue	orange	purple	pink
<b>GR</b>	σκούρο	φωτεινό	μαύρο	λευκό	καφέ	πράσινο	γκρι	κόκκινο	κίτρινο	μπλε	πορτοκαλί	Μωβ	ροζ
<b>H</b>	sötét	fényes	fekete	fehér	barna	zöld	szürke	piros	sárga	kék	narancssárga	ibolyakék	rózsaszín
<b>I</b>	scuro	luminoso	nero	bianco	marrone	verde	grigio	rosso	giallo	blu	arancione	viola	rosa
<b>N</b>	mørk	lyse	svart	hvit	brun	grønn	grå	rød	gul	blå	oransje	fiolett	rosa
<b>NL</b>	donkere	heldere	zwart	wit	bruin	groen	grijs	rood	geel	blauw	oranje	violet	rosé
<b>PL</b>	ciemny	jasno	czarno	biały	brązowo	zielony	szaro	czzerwony	żółty	niebieski	pomarańczowe	fioletowe	różowa
<b>RUS</b>	темно	светло	черный	белый	коричневый	зеленый	серый	красный	желтый	голубой	оранжевый	пурпурный	розовый
<b>S</b>	mörk	ljus	svart	vit	brun	grön	grå	röd	gul	blå	orange	violett	rosa

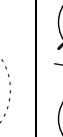
																																																																																																																																																																																																																																																																																																																																																																										
---	---	---	---	---	---	---	---	---	---	---	---	---	---	---	---	---	---	---	---	---	---	---	---	---	---	---	---	---	---	---	---	---	---	---	---	---	---	---	---	---	---	---	---	---	---	---	---	---	---	---	---	---	---	---	---	---	---	---	---	---	---	---	---	---	---	---	---	---	---	---	---	---	---	---	---	---	---	---	---	---	---	---	---	---	---	---	---	---	---	---	---	---	---	---	---	---	---	---	---	---	---	---	--	--	--	--	--	--	--	--	--	--	--	--	--	--	--	--	--	--	--	--	--	--	--	--	--	--	--	--	--	--	--	--	--	--	--	--	--	--	--	--	--	--	--	--	--	--	--	--	--	--	--	--	--	--	--	--	--	--	--	--	--	--	--	--	--	--	--	--	--	--	--	--	--	--	--	--	--	--	--	--	--	--	--	--	--	--	--	--	--	--	--	--	--	--	--	--	--	--	--	--	--	--	--	--	--	--	--	--	--	--	--	--	--	--	--	--	--	--	--	--	--	--	--	--	--	--	--	--	--	--	--	--	--	--	--	--	--	--	--	--	--	--	--	--	--	--	--	--	--	--	--	--	--	--	--	--	--	--	--	--	--	--	--	--	--	--	--	--	--	--	--	--	--	--	--	--	--	--	--	--	--	--	--	--	--	--	--	--	--	--	--	--	--	--	--	--	--	--	--	--	--	--	--	--	--	--	--	--	--	--	--	--	--	--	--	--	--	--	--	--	--	--	--	--	--	--	--	--	--	--	--	--	--	--	--	--	--	--	--	--	--	--	--	--	--	--	--	--	--	--	--	--	--	--	--	--	--	--	--	--

	D	CZ	DK	E	F	FIN	GB	GR	H	I	N	NL	PL	RUS	S
	keine Feuchtigkeit	Žádná vlhkost	Ingen fugtighed	No hay humedad	Pas d'humidité	ei kosteutta	no lubrication	όχι υγρασία	nedvességet	assenza di umidità	ingen fugtighet	Geen vocht	Brak wilgoci	Нет жидкости	ingen fukt
	LED Prüflampe	Zkušební LED svítilna	LED testlampe	Lámpara de prueba de LED	Lampe de contrôle à diode	LED tarkastuslamppu	LED test lamp	Λυχνία ελέγχου LED	LED ellenőrző lámpa	Luce di verifica LED	LED testlampe	LED control-lampje	Lampka kontrolna LED	Светодиодная контрольная лампа	LED kontrolllampa
	Rechtslenker	Pravostranní řízení	Højrestyret	con dirección a la derecha	Direction à droite	Ohjaua oikealla puolella	right-hand drive vehicle	Δεξιόημιόριο	jobb kormány	Guida a destra	Ratt på høyre side	Stuur rechts	Kierownica z prawej strony	Автомобиль с правосторонним расположением рулевого управления	Högerstyrt fordon
	Linkslenker	Levostranní řízení	Venstrestyret	con dirección a la izquierda	Direction à gauche	Ohjaua vasemmalla puolella	left-hand drive vehicle	Αριστερόημιόριο	balkormány	Guida a sinistra	Ratt på venstre side	Stuur links	Kierownica z lewej strony	Автомобиль с левосторонним расположением рулевого управления	Vänsterstyrt fordon
	mit Einparkhilfe	S parkovací asistent	Med parkeringshjelp	con asistencia de estacionamiento	Avec aide au stationnement	Pysäköintipuu	with parking aid	Με σύστημα παρακαρπάριατος	beparkolási támogatással	con ausilio al parcheggio	med parkeringsassistent	Met parkeer-sensor	z asystentem parkowania	С парковочным радаром	med parkeringshjelp
	ohne Einparkhilfe	Bez parkovací asistenta	Uden parkeringshjelp	sin asistencia de estacionamiento	Sans aide au stationnement	Ei pysäköintipuu	without parking aid	Χωρίς σύστημα παρακαρπάριατος	beparkolási támogatás nélkül	senza ausilio al parcheggio	uten parkeringsassistent	Zonder parkeer-sensor	bez asystenta parkowania	Без парковочного радара	utan parkeringshjelp
	Datenbusleitung (CAN)	Datový kabel sběrnice CAN	Databusledning (CAN)	Cable de bus de données (CAN)	Câble de bus de données (CAN)	Tietoväylä (CAN)	data bus cable (CAN)	Αγωγός διαύλου δεδομένων (CAN)	adatsbus vezetékek (CAN)	Linea bus di dati (CAN)	Databusledning (CAN)	Gegevensbuslijn (CAN)	Przewód magistrali danych (CAN)	Однопроводная шина данных (CAN)	Databusledning (CAN)
	CAN High Signal	Vysokovýštní sběrnice CAN	CAN High signal	Señal CAN High	Signal CAN haut	CAN - signaali korkealla	CAN high signal	Σήμα CAN High	CAN High jel	Segnale CAN High	CAN High-signal	CAN High Signal	CAN High Signal	Сигнал CAN High	CAN High Signal
	CAN Low Signal	Nizkovýštní sběrnice CAN	CAN Low signal	Señal CAN Low	Signal CAN faible	CAN - signaali matalalla	CAN low signal	Σήμα CAN Low	CAN Low jel	Segnale CAN Low	CAN Low-signal	CAN Low Signal	CAN Low Signal	Сигнал CAN Low	CAN Low Signal
	Karosseriebohrung und Versiegelung	Vyvrátí díru do karosérie a následně ji zapraví	Bor og forsegl hul	Perforar agujero de carrocería y sellarlo	Perçage et masticage des trous de carrosserie	Kori, poraa reikää ja tiivistää	drill and seal bodywork hole	Διτρυφή και σφράγιση οπής στο αμάξωμα	lyuk fúrás a karosszeriárás és lezárás	Trapanare e sigillare i fori carrozzeria	Bore og forsegle hull i karosseriet	Carosseriegat boren en verzegelen	Wykonać otwór w karoserii i zabezpieczyć	Просверлить и запечатать отверстие в кузове	Borra och forsegl karosshål
	Klebeband	Lepicí páska	Tape	Cinta adhesiva	Ruban adhésif	Liimanauha	adhesive tape	Κολλητική ταινία	ragasztószalag	Nastro adesivo	Limbånd	Kleefband	Tasma klejająca	Клейкая лента	Tejp
	Radio Codierung beachten	Pozor na kód rádia	Bemærk radio kodning	Tener en cuenta código radio	Attention à la codification radio	Huomaa radio-koodaus	observe radio coding	Προσοχή στην συμπιαική κωδικοποίηση	a rádió kódolására figyelni	Rispettare codifica radio	Vær oppmerksom på radokoding	Radio-codering in acht nemen	Uwzględnić kodowanie radia	Учитывать кодировку радио	Observera radiokodning
	Achtung! Säure	Pozor! Kyseliny	OBS! Syre	¡Atención! Ácido	Attention ! Acide	Huomio! Happoa	Warning! acid	Προσοχή! Οξύ	Figyelem! Sav	Attenzione! Acido	Obs! Syre	Opgelet! Zuren	Uwaga! kwas	Внимание! Кислота	Observera Syra

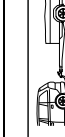
		<b>S</b>	Cigaretändare, 12V uttag	<b>RUS</b>	Прикуриватель, розетка 12 В	<b>PL</b>	Zapalniczka, gniazdko 12V	<b>NL</b>	Sigarettenaansteker, 12V stopcontact	<b>N</b>	Sigarettenneer, 12 V stikkontakt	<b>I</b>	Accendisigari, presa da 12 V	<b>H</b>	szivargyújtó, 12V-os dugalj	<b>GR</b>	Αναπτήρας, τριπόδι 12V	<b>GB</b>	cigarette lighter, 12V socket	<b>FIN</b>	Savukkeensytytin, 12V-pistoke	<b>F</b>	Prise allume-cigare, 12V	<b>E</b>	Encendedor de cigarrillos, enchufe de 12V	<b>DK</b>	Cigaret tænder, 12V stikkåse	<b>CZ</b>	Zapalovač, 12V zásuvka	<b>D</b>	Zigarettenanzünder, 12V Steckdose											
			Fordon test/programeringsdon	Устройство тестирования / программа ования автомобиля	Test pojazduluiz. program.	Functia pomianu/por. colorow kabil	Voertuig-test/programmeer-apparaat	Functie kabelkeurultmeten / vergelijken	Kjøretøy test/programeringsenh et	Måle / sammenlign e funksjon kabelfarge	Misure / confronto re funzio ne colore cavo	Járműteszt/programozó készülék	Συσκευή δοκιμής/πρωτ. οχήματος	Λειτουργία μέτρησης/ σύγκρισης χρωματισμού καλωδίων	Επισημάνση αποκλίσεων χρωματισμού καλωδίου	Απομάκρυνση κλειδιών / Chipcard 10m van het voertuig verwijderen!	Knop in het voertuig aanwezig ja / nee	Knapp finnes i kjøretøyet ja / nei	Tasto presente nel veicolo sì / no	Collegare	collegare	Indicatore di segnale	rispettare / riconoscere	figyelembe venni / felismerni	Προσοχή / αναγνώριση	Αναγνώριση οχήματος έυου	Trailer signal recognized	Perävaunun signaali tunnistettu	Observer / reconnaitre	Señal remolque detectada	benmærk / registrere	Rozpoznání signálu přívěsu	Signal Anhänger erkannt	Signal släpvagn identifierad								



**D**

Nationale Richtlinien über die Anbauabnahmen sind zu beachten.

Jegliche Änderungen bzw. Umbauten an der Elektroanlage sind verboten. Sie führen zum Erlöschen der Betriebserlaubnis. Vor Arbeitsbeginn die Einbauanleitung lesen.

Wichtig: Prüfen Sie den Inhalt des Sets, bevor Sie mit der Installation beginnen und melden Sie gegebenenfalls Abweichungen. Beginnen Sie erst mit der Installation, wenn Sie über ein vollständiges Set verfügen.

Die Elektroanlage für Anhängervorrichtung darf nur von Fachunternehmen montiert werden. Bei falscher Montage besteht schwere Unfallgefahr!

Westfalia-Automotive haftet nicht für Personen- oder Sachschäden beziehungsweise Verluste, die durch die Installation oder eine fehlerhafte Montage oder Nutzung des Produkts verursacht werden.

Arbeiten an Airbags dürfen nur von entsprechend geschultem Personal durchgeführt werden.

Achtung – vor Arbeitsbeginn den Fehlerspeicher auslesen, ggf. Ruhestrom-Erhaltungsgerät verwenden, ansonsten können elektronisch gespeicherten Daten verloren gehen. Batterie abklemmen, um Beschädigungen der KFZ- Elektronik zu vermeiden.

Für technische Änderungen, Software updates, die nach Erst- Inbetriebnahme z.B. durch den Fahrzeughersteller durchgeführt werden und zu Fehlfunktionen bei Anhängerbetrieb führen, kann keine Gewährleistung übernommen werden.

Leitungen dürfen weder eingeklemmt noch beschädigt sein. Alle Dichtungselemente ordnungsgemäß anbringen.

Bei Anhängerbetrieb wird die Nebelschlussleuchte des Zugfahrzeugs abgeschaltet.

Ein Steckdosenadapter darf nur im Anhängerbetrieb genutzt werden.

- Der Ausfall der Anhängerblinkleuchten wird durch die Erhöhung der Blinkfrequenz im Cockpit angezeigt.

Die Prüfung der Anhängerfunktionen mit einem Anhänger oder einem Prüfgerät mit Belastungswiderständen durchführen.

Achtung! Es ist sicherzustellen das alle Anforderungen des Fahrzeughersteller zu Änderungen und Nachrüstungen am Fahrzeug und/oder Kühlsystem für den Betrieb mit Anhänger durchgeführt wurden.

Bitte beachten: Mit diesem E-Satz werden bei Anhängerbetrieb die fahrzeugseitigen Assistenzsysteme nicht beeinflusst oder verändert.

**Der deutsche Text dieser Anleitung ist bindend.**

Änderungen vorbehalten.

**CZ**

Je nutné dodržovat místní směrnice o demontáži nástaveb.

Veškeré změny příp. přestavby elektrického zařízení jsou zakázány. Mají za následek zánik platnosti povolení k provozu.

Před zahájením práce si prostudujte návod k montáži.

Důležité: Před montáží zkontrolujte obsah soupravy a nahláste případné odlišnosti. S montáží začněte pouze v případě, že máte k dispozici kompletní soupravu.

Elektrické zařízení pro tažné zařízení smí montovat pouze odborné podniky. Při chybné montáži hrozí vážné nebezpečí nehody! Společnost Westfalia-Automotive není zodpovědná za případná zranění, škody na majetku nebo ztráty na zisku, které mohou být způsobeny chybnou montáží nebo nesprávném používáním výrobku.

Práce na airbagů by měl provádět pouze řádně vyškolení pracovníci.

Pozor – před zahájením práce načtěte paměť chyb, popř. použijte zařízení pro udržení klidového proudu, jinak můžete ztratit elektronicky uložená data. Odpojte akumulátorovou baterii, aby nedošlo k poškození elektronické soustavy vozidla.

Neneseme žádnou zodpovědnost za technické změny a aktualizace softwaru provedené po prvním uvedení do provozu (např. výrobcem vozidla), které mohou způsobit nesprávnou funkci přívěsu.

Vodiče nesmí být sevřené ani poškozené. Všechny těsnicí prvky náležitě namontujte.

Při provozu s tažným zařízením se vypne koncové světlo do mlhy na tažném vozidle.

Adaptér zásuvky se smí používat jen při provozu s přívěsem.

- Výpadek směrových světel přívěsu je indikován ve vozidle zvýšenou frekvencí blikání.

Kontrolu funkcí přívěsu provádějte pomocí přívěsu nebo vhodného kontrolního přístroje se zatěžovacími odpory.

Pozor! Ujistěte se, zda jsou splněny všechny podmínky provozu přívěsu stanovené výrobcem vozidla a zda byly provedeny všechny úpravy a dodatečné vybavení vozidla či chladicího systému.

Vezměte prosím na vědomí: Tato e-nastavení palubní asistenčních systémů nejsou ovlivněny nebo změněny při jízdě s přívěsem.

**Německý text tohoto návodu je závazný.**

Změny vyhrazeny.

**DK**

De nationale direktiver for montering af tilbehør skal overholdes.

Enhver ændring eller ombygning på el-anlægget er forbudt. Dette medfører, at typegodkendelsen ikke er gældende.

Læs monteringsvejledningen inden påbegyndelse af arbejdet.

Vigtigt: Kontrollér sættets indhold inden du begynder med installationen og meddel i givet fald afvigelser. Begynd først installationen, når du har et komplet sæt.

Elsættet til anghængertrækket må kun monteres af kvalificeret personel. Ved forkert montering er der fare for alvorlige fejlfunktioner!

Westfalia-Automotive overtaget ikke ansvaret for person- eller tingskader henholdsvis for tab, der er forårsaget af en forkert installation, montage eller anvendelse af produktet.

Arbejdet med airbags bør kun udføres af dertil uddannet personale.

Bemærk – udlæs fejlloggen inden påbegyndelse af arbejdet, anvend evt. apparat til opretholdelse af hvilestrøm, ellers kan elektronisk lagrede data gå tabt. Frakobl batteriet for at undgå beskadigelse af personbilens elektronik.

For tekniske ændringer, software-updates, der gennemføres efter den første ibrugtagning, f.eks. af køretøjsproducenten og som medfører fejlfunktioner i anghængerdriften, kan der ikke overtages noget ansvar.

Ledningerne må ikke hverken blive klemt eller beskadiget. Alle tætningsselementerne skal anbringes efter forskrifterne.

Ved brug af anghængerens elastik frakobles trækkøretøjets tågebaglygte.

En stikdåseadapter må udelukkende anvendes ved drift med anghænger.

- Svigt af anghængerens blinklys vises via en forhøjet blinkfrekvens i instrumentpanelet.

Kontrol af anghængerfunktionerne skal foretages med en anghænger eller et kontrolapparat med belastningsmodstand.

OBS! Kontrollér, at alle køretøjsproducentens krav til ændringer og eftermonteringer på køretøj og/eller kølesystem til brug med anghænger er blevet gennemført.

Bemærk: denne e-indstille indbyggede hjælpesystemer er ikke berørt eller ændres ved kørsel med anghænger.

**Den tyske tekst i denne vejledning er bindende.**

Ret til ændringer forbeholdes.

**E**

Deben respetarse las directivas nacionales referentes a controles de enganches.

Está prohibido modificar o remodelar la instalación eléctrica. La consecuencia sería la invalidación del permiso de circulación. Antes de iniciar la tarea, lea las instrucciones de montaje.

Importante: Verifique el contenido del juego antes de comenzar con la instalación y notifique las diferencias si las hubiera. Comience con la instalación recién cuando disponga de un juego completo.

La instalación eléctrica para el dispositivo de remolque sólo debe montarla personal cualificado. ¡En caso de montaje erróneo existe peligro de accidentes graves!

Westfalia-Automotive no asume ninguna responsabilidad por daños personales o materiales, respectivamente pérdidas, que sean causados por la instalación o por un montaje o uso del producto deficientes.

Trabajo sobre las bolsas de aire sólo debe ser realizada por personal debidamente capacitado.

Atención – antes de iniciar la tarea, leer la memoria de fallos, si es necesario utilizar un dispositivo de mantenimiento de corriente de reposo, de lo contrario podría perder los datos memorizados electrónicamente. Desconecte la batería para evitar daños en la instalación eléctrica del vehículo.

No puede asumirse ninguna garantía por modificaciones técnicas o actualizaciones de software que hayan sido realizadas después de la primera puesta en servicio, p. ej. por el fabricante del vehículo, y que causen funcionamientos defectuosos en la operación del remolque.

Se debe evitar dañar o aprisionar los cables. Instalar correctamente todas las juntas.

Al circular con remolque se desconecta la luz antiniebla trasera del vehículo de tiro.

Sólo se puede usar un adaptador de caja de enchufe cuando se circule con remolque.

- Un error de los intermitentes del remolque se indicará aumentando la frecuencia de parpadeo en el cuadro de mando.

La comprobación de las funciones del remolque debe efectuarse con un remolque o bien con un equipo de comprobación con resistores reguladores de carga.

¡Atención! Se debe asegurar que se ha cumplido con todos los requerimientos del fabricante del vehículo en lo que respecta a modificaciones y reequipamiento en el vehículo y/o sistema de refrigeración para la operación con remolque.

Tenga en cuenta: este e-establecen los sistemas de asistencia a bordo no se ven afectados o se cambian de un remolque.

**Es vinculante el texto alemán de estas instrucciones.**

Nos reservamos el derecho a efectuar modificaciones.

**F**

Les dispositions nationales concernant la réception à titre isolé doivent être respectées.

Toute modification ou transformation de l'installation électrique est interdite. Elle entraînerait l'annulation de la réception.

Lire impérativement la notice de montage avant de commencer le travail.

Important : Vérifier le contenu de l'ensemble avant de commencer l'installation et mentionner le cas échéant les anomalies. Ne commencer l'installation que lorsque vous disposez d'un ensemble complet.

Seules des entreprises spécialisées sont autorisées à monter le faisceau électrique du dispositif d'attelage. Un montage incorrect représente un risque élevé d'accident !

Westfalia-Automotive n'est pas tenu responsable des dommages aux personnes ou matériels ou bien de pertes qui seraient causés par l'installation ou un montage défectueux ou une mauvaise utilisation du produit.

Travail sur les airbags ne doivent être effectuées que par du personnel formé.

Attention – Avant de commencer le travail, éliminer l'ensemble des défauts présents dans la mémoire de l'ordinateur de bord ou utiliser un générateur de courant de veille pour éviter que des données enregistrées sur support électroniques ne soient perdues. Débrancher la batterie afin d'éviter tout endommagement de l'installation électronique du véhicule.

Aucune garantie ne peut être prise en charge eu égard aux modifications techniques, aux mises à jours de logiciel qui sont effectuées après la première mise en marche, par ex. : par le fabricant du véhicule et qui conduisent à des fonctionnements défectueux de la remorque.

Les fils électriques ne doivent être ni endommagés ni coincés. Mettre en place tous les éléments d'étanchéité conformément à la notice.

Lorsqu'une remorque/caravane est attelée, le fonctionnement du feu de brouillard arrière du véhicule tracteur est interrompu.

Un adaptateur pour prise de courant ne doit être utilisé que si une remorque/caravane est tractée.

- Une panne des clignotants de la remorque/caravane est signalée par l'augmentation de la fréquence de clignotement dans l'habitacle.

Le contrôle des fonctions de l'attelage doit s'effectuer avec une remorque ou avec un appareil de contrôle muni d'ampoules classiques.

Attention ! Il convient de s'assurer que toutes les consignes imposées du fabricant du véhicule ont été respectées concernant les modifications et les équipements ultérieurs réalisés sur le véhicule et/ou le système de refroidissement pour l'utilisation avec la remorque.

S'il vous plaît noter: Cet e-définir les systèmes d'assistance à bord ne sont pas affectés ou modifiés en tractant une remorque.

**Le texte allemand de cette notice fait foi.**

Sous réserve de modifications.

**FIN**

Kansallisia suuntaviivoja, mitä tulee asennukseen, on noudatettava.

Kaikki sähköjärjestelmään tehtävät muutokset tai jälkiasennukset ovat kiellettyjä. Nämä johtavat käyttöluvan raukeamiseen. Lue asennusohjeet ennen työskentelyn aloittamista.

Tärkeää: Tarkasta sarjan sisältö, ennen kuin aloitat asennuksen ja ilmoita mahdollisista poikkeamista. Aloita asennus vasta, kun olet varma, että sarja on täydellinen.

Vetolaitteen sähköjärjestelmän saa asentaa vain alan erikoisliike. Virheellinen asennus voi aiheuttaa vakavan onnettomuuden! Westfalia-Automotive ei vastaa henkilö- tai esinevahingoista tai muistakaan vahingoista, jotka ovat seurausta tuotteen virheellisestä asennuksesta tai käytöstä.

Työ turvatyyny saa suorittaa vain asianmukaisesti koulutettu henkilöstö.

Huomio: lue vikamuisti ennen työskentelyn aloittamista. Käytä tarvittaessa lepovirran säilymisen varmistavaa laitetta, jotta elektronisesti tallentuneet tiedot eivät katoa muistista. Irrota akun navat, jotta ajoneuvon elektroniikka ei vaurioidu.

Valmistaja ei vastaa teknisistä muutoksista tai ohjelmistopäivityksistä, jotka toteutetaan ensimmäisen käyttöönoton jälkeen tai ajoneuvon valmistajan toimesta ja joista on seurauksena perävaunun käyttöön virhetoimintoja.

Johdot eivät saa jäädä puristuksiin eivätkä vaurioitua. Kiinnitä kaikki tiiviste-elementit asianmukaisesti.

Vetoajoneuvon takasumivalot eivät toimi vetolaitteen käytön aikana.

Pistorasia-adapteria saa käyttää ainoastaan perävaunun yhteydessä.

- Perävaunun suuntavilkkujen toimintahäiriön ilmaisee merkkivalon vilkkumistaajuuden kasvu ohjaamossa.

Perävaunuun liittyvät toiminnot on testattava joko perävaunun kanssa tai kuormitusvastuksilla varustetulla testauslaitteella.

Huomio! On varmistettava, että kaikkia ajoneuvon valmistajan ajoneuvoon ja/tai jäähdytysjärjestelmään tehtäviin muutoksiin ja jälkivarusteluihin, jotka koskevat perävaunun käyttöä, liittyviä vaatimuksia noudatetaan.

Huomaa: tämä e-set laivalla avustinjärjestelmät ei vaikuta tai muuttaa perävaunua vedettäessä.

**Tämän ohjeen saksankielinen teksti on sitova.**

Oikeudet muutoksiin pidätetään.

**GB**

Observe national guidelines on the approval of accessories.

Any alteration or modification of the electrical system is prohibited and voids the operating licence.

Read the installation manual before beginning to work.

Important: Check contents of kit before commencing installation and report any discrepancies. Do not commence installation unless you have a complete kit.

Only qualified companies may install the electrical system for the trailer hitch. Improper assembly may result in a serious accident hazard!

Westfalia-Automotive is not liable for personal injury, damage or loss caused by the installation or improper assembly or use of the product.

Work on airbags should only be performed by properly trained personnel.

Attention – before starting to work, read out the errors stored in the memory. If required, use a power supply to prevent electronically saved data from being erased. Disconnect the battery to prevent damage to the vehicle electronics.

No guarantee can be given for the malfunctioning of the trailer operation caused by technical changes, software updates, carried out by the vehicle manufacturer, for example, after the initial commissioning.

Verify that no cables are squeezed or damaged. Properly install all seals.

When towing a trailer, the rear fog light of the pulling vehicle is switched off.

An electrical socket adapter may only be used when towing a trailer.

- A failure of the trailer turn signal lamps is indicated by an increased flashing rate of the pilot lamp in the cockpit.

Check the trailer functions with a trailer or a testing instrument with load resistors.

Warning! It must be ensured that all the requirements of the vehicle manufacturer for changes to and retro-fitting on the vehicle and / or cooling system for the operation with a trailer are carried out.

Please note: this e-set do not affect or change the onboard assistance systems when towing a trailer.

**The German text of this instruction is binding.**

Subject to change.

**GR**

Πρέπει να τηρούνται οι κρατικοί κανονισμοί σχετικά με τον έλεγχο προσθηκών στα αμαξώματα.

Απαγορεύονται οι αλλαγές και οι μετατροπές στην ηλεκτρική εγκατάσταση. Συναπτάγονται την ακύρωση της άδειας λειτουργίας.

Πριν από την έναρξη των εργασιών μελετήστε τις οδηγίες τοποθέτησης.

Σημαντικό: Ελέγξτε το περιεχόμενο του σετ προτού αρχίσετε τις εργασίες εγκατάστασης, και αναφέρετε τυχόν αποκλίσεις. Αρχίστε την εγκατάσταση μόνο εφόσον το σετ που διαθέτετε είναι πλήρες.

Το ηλεκτρικό σύστημα για διατάξεις ρυμούλκησης επιτρέπεται να τοποθετείται μόνο από ειδικά συνεργεία. Σε περίπτωση λάθους τοποθέτησης υπάρχει κίνδυνος σοβαρών ατυχημάτων!

Η Westfalia-Automotive δεν φέρει ευθύνη για τραυματισμούς, ζημιές ή απώλειες που προκαλούνται από την εγκατάσταση ή από τυχόν εσφαλμένη τοποθέτηση ή χρήση του προϊόντος.

Οι εργασίες σχετικά με τους αερόσακους θα πρέπει να εκτελείται μόνο από κατάλληλα εκπαιδευμένο προσωπικό.

Προσοχή – Πριν από την έναρξη των εργασιών διαβάστε τη μνήμη σφαλμάτων ή αντίστοιχα χρησιμοποιήστε μία συσκευή διατήρησης ρεύματος. Διαφορετικά μπορεί να χαθούν τα ηλεκτρικά αποθηκευμένα δεδομένα. Αποσυνδέστε την μπαταρία ώστε να αποφευχθούν οι ζημιές στα ηλεκτρονικά του οχήματος.

Για τεχνικές αλλαγές και ενημερώσεις λογισμικού μετά την πρώτη θέση σε λειτουργία που εκτελούνται π.χ. από τον κατασκευαστή του οχήματος και οδηγούν σε σφάλματα λειτουργίας του συστήματος ρυμούλκησης, δεν αναλαμβάνεται ευθύνη.

Τα καλώδια δεν πρέπει ούτε να μαγκώνονται ούτε να είναι χαλασμένα. Τοποθετήστε σωστά όλα τα στοιχεία στεγανοποίησης.

Κατά την οδήγηση με τρέιλερ το πίσω φανάρι ομίχλης του έλκοντος οχήματος απενεργοποιείται.

Ένας προσαρμογέας πρίζας επιτρέπεται να χρησιμοποιηθεί μόνο κατά την οδήγηση με τρέιλερ.

- Η τυχόν βλάβη των φώτων της διάταξης ρυμούλκησης εμφανίζεται στο ταμπλό με αύξηση της συχνότητας αναβοσβήσματος.

Ο έλεγχος των λειτουργιών της ρυμούλκας πρέπει να γίνεται ή με μία ρυμούλκα ή με μια συσκευή μετρήσεων με αντιστάσεις καταπόνησης.

Προσοχή! Θα πρέπει να διασφαλιστεί ότι έχουν υλοποιηθεί όλες οι απαιτήσεις του κατασκευαστή του οχήματος για μετατροπές και προσθήκες εξοπλισμού στο όχημα ή/και το σύστημα ψύξης, οι οποίες σχετίζονται με τη λειτουργία με ρυμούλκούμενο.

Παρακαλώ σημειώστε: Αυτό το ηλεκτρονικό ρυθμίστε τα συστήματα επί του σκάφους βοήθειας δεν επηρεάζονται ή να αλλάξει κατά τη ρυμούλκηση τρέιλερ.

**Το γερμανικό κείμενο αυτών των οδηγιών είναι δεσμευτικό.**

Διατηρούμε το δικαίωμα αλλαγών.

**H**

Figyelembe kell venni a műszaki átvételre vonatkozó nemzeti irányelveket.

Az elektromos felszerelésen tilos bármiféle átalakítást végezni. A szerkezet megváltoztatása vagy átalakítása a forgalmi engedély megszűnését vonja maga után.

A munka megkezdése előtt olvassa el a szerelési útmutatót.

Fontos: A beépítés megkezdése előtt ellenőrizze a garnitúra tartalmát és adott esetben jelentse az eltéréseket. Csak akkor kezdje meg a beépítést, ha teljes garnitúra rendelkezésére áll.

A vonószerkezet elektromos részét csak szaküzem szerelheti be. Helytelen szerelés súlyos balesethez vezethet!

A Westfalia-Automotive nem vállal felelősséget a beépítés vagy hibás szerelés vagy a termék használata által okozott személyi sérülésekért vagy dologi károkért.

Végzett munka légszákok csak akkor kell elvégezni a megfelelően képzett személyzet.

Figyelem– a munka megkezdése előtt olvassa ki a hibatárolót, adott esetben használjon nyugalmi áramot fenntartó készüléket, máskülönben elveszhetnek az elektronikusan tárolt adatok. Kösse le az akkumulátort, hogy megelőzze a gépjármű elektronikájának megrongálódását.

Az első üzembe helyezés után pl. a járműgyártó által elvégzett és az utánfutó hibás működéséhez vezető műszaki változtatásokért, szoftverfrissítésekért jótállás nem vállalható.

A vezetékek nem lehetnek becsípődve vagy megrongálódva. Minden szigetelő elemet a rendeltetésének megfelelően szereljen.

Utánfutóüzemben ki lesz kapcsolva a vontatójármű hátsó ködlámpája.

Dugóaljzat adaptert csak vontatóüzemben szabad használni.

- Az utánfutó indexlámpáinak kiesését a műszerfalon a villogás gyorsulása jelzi.

Ellenőrizze az utánfutó funkciók működését egy utánfutóval vagy egy terhelő ellenállásokkal ellátott ellenőrzőkészülékkel.

Figyelem! Biztosítani kell, hogy a járműgyártónak az utánfutóval történő működtetés érdekében a járművön és/vagy a hűtőrendszeren elvégzendő változtatásokra vonatkozó minden követelménye teljesüljön.

Megjegyzés: Ez az e-set a fedélzeti rendszerek pedig nem érintett, vagy megváltozott utánfutó vontatása esetén.

**A német szerelési utasítás betartása kötelező.**

Változtatások jogát fenntartjuk.

**I**

Devono essere osservate le normative nazionali sui collaudi.

È vietato modificare o montare diversamente l'impianto elettrico. Ciò comporta l'annullamento del permesso di circolazione.

Prima di iniziare i lavori, leggere le istruzioni di montaggio.

Importante: Controllare il contenuto del kit, prima di iniziare l'installazione e segnalare eventuali divergenze. Iniziare l'installazione soltanto quando il kit di cui si dispone è completo.

L'impianto elettrico per il gancio di traino deve essere montato solo da personale specializzato. In caso di montaggio errato sussiste il pericolo di incidenti gravi!

Westfalia-Automotive non è responsabile per danni a cose o persone o nello specifico di perdite verificatesi in seguito all'installazione, al montaggio o all'uso difettoso del prodotto.

Il lavoro sul airbag deve essere eseguita solo da personale addestrato.

Attenzione – prima di iniziare i lavori, leggere la memoria errori, se necessario utilizzare un dispositivo di mantenimento della corrente di riposo per non perdere i dati memorizzati. Scollegare la batteria al fine di evitare danni all'impianto elettronico del veicolo.

Non si assume responsabilità alcuna per modifiche tecniche e aggiornamenti software che vengono effettuati dopo la prima messa in funzione dal costruttore del veicolo e che possono provocare il funzionamento difettoso del rimorchio.

I cavi non devono essere schiacciati né danneggiati. Installare correttamente gli elementi di tenuta.

Durante il funzionamento con rimorchio la luce antinebbia posteriore della motrice viene spenta.

Utilizzare un adattatore per prese esclusivamente per il funzionamento con rimorchio.

- Un guasto agli indicatori di direzione del rimorchio viene segnalato da una frequenza di lampeggio più veloce sul quadro comandi.

Il controllo delle funzioni del rimorchio deve essere eseguito con un rimorchio o con un apparecchio di controllo con resistenza di carico.

Attenzione! Occorre controllare che vengano rispettati tutti i requisiti del costruttore del veicolo relativi alle modifiche e agli accessori sul veicolo e/o sull'impianto del raffreddamento per l'esercizio del rimorchio.

Attenzione: questo e-impostare i sistemi di assistenza a bordo non sono interessati o modificati quando si traina un rimorchio.

**È vincolante il testo tedesco di queste istruzioni.**

Con riserva di modifiche.

**N**

Nasjonale retningslinjer om godkjenning av monteringer skal overholdes.

Enhver endring hhv. ombygging av det elektriske anlegget er forbudt. Dette vil ødelegge brukeropplevelsen.

Les montasjeveiledningen før man begynner arbeidet.

Viktig: Kontroller innholdet i settet før du starter installasjonen og meld fra om eventuelle avvik. Start installasjonen først når du har et fullstendig sett.

Det elektriske anlegget til tilhengerfestet må kun monteres av fagbedrift. Det er stor fare for at det kan oppstå ulykker ved feil montering!

Westfalia-Automotive er ikke ansvarlig for personskader eller materielle skader hhv. tap som skyldes installasjon eller feil montering eller bruk av produktet.

Arbeid på kollisjonsputer bør kun utføres av personell med tilstrekkelig opplæring.

OBS – før arbeidet starter må man lese av feilminnet hhv. benytte hvilestrøms-måleapparat for å unngå at elektronisk lagrede data går tapt. Koble fra batteriet for å unngå at kjøretøyelektronikken skades.

Det blir ikke gitt noen garanti for tekniske endringer, programvareoppdateringer som utføres etter første igangkjøring f.eks. av kjøretøyprodusenten, og som fører til funksjonsfeil ved bruk av tilhengeren.

Ledninger må verken klemmes fast eller skades. Alle tettningsselementer må monteres på plass i riktig posisjon.

Ved bruk av tilhenger blir baklysene til trekkvognen koblet ut.

Stikkontaktadapteret må kun brukes i kombinasjon med tilhenger.

- Hvis blinklysene på tilhengeren faller ut, indikeres dette i førerhuset ved at blinkfrekvensen øker.

Kontrollen av tilhengerfunksjonen foretas med en tilhenger eller et kontrollinstrument med belastningsmotstander.

Obs! Man må forsikre seg om at alle kravene til kjøretøyprodusenten vedrørende endringer og etterutrustninger på kjøretøyet og/eller kjølesystemet ble gjennomført for drift med tilhenger.

Vennligst merk: Denne e-set ombord assistentsystemer er ikke berørt eller endret ved kjøring med tilhenger.

**Den tyske teksten i denne veiledningen er bindende.**

Med forbehold om endringer.

**NL**

Nationale richtlijnen betreffende de montagegoedkeuring moeten in acht worden genomen.

Elke wijziging van de elektrische installatie is verboden. Wijziging leidt tot verval van de gebruikstoestemming.

Voor montage eerst de inbouwhandleiding lezen.

Belangrijk: controleer de inhoud van de set voor u met de installatie begint en meld eventuele afwijkingen. Begin pas met de installatie wanneer u over een volledige set beschikt.

De elektrische installatie voor aanhanger mag alleen door vakkundig personeel worden gemonteerd. Bij verkeerde montage bestaat ernstig gevaar voor ongevallen!

Westfalia-Automotive kan niet verantwoordelijk worden gesteld voor materiële schade, lichamelijke letsels of voor mogelijk verlies dat door de installatie, foutieve montage of verkeerd gebruik van het product werd veroorzaakt.

Werkzaamheden aan airbags mag alleen worden uitgevoerd door goed opgeleid personeel.

Attentie – voor montage het foutgeheugen aflezen, eventueel ruststroomapparaat gebruiken, anders kunnen elektrisch opgeslagen gegevens verloren gaan. Los de accu klemmen om beschadiging van de voertuigelektroniek te vermijden.

Voor technische wijzigingen, software-updates die na de eerste ingebruikneming (bijv. door de fabrikant van het voertuig) worden uitgevoerd en bij het gebruik van de aanhangwagen tot storingen leiden, kan Westfalia niet verantwoordelijk worden gesteld.

Leidingen mogen niet klemmen of beschadigd zijn. Alle afdichtelementen volgens voorschrift aanbrengen.

Bij gebruik van de aanhanger wordt het mistachterlicht van het voertuig uitgeschakeld.

Een contactdoosadapter mag uitsluitend bij het rijden met aanhangwagen worden gebruikt.

- Uitvallen van de aanhangerknipperlichten wordt door een verhoogde knipperfrequentie in de het instrumenten paneel aangegeven.

De controle van de aanhangerfuncties met een aanhanger of een testapparaat met belastingsweerstand uitvoeren.

Opgelet! Zorg ervoor dat voor de werking met aanhangwagen aan alle eisen van de voertuigfabrikant i.v.m. veranderingen en wijzigingen aan het voertuig en/of koelsysteem werd voldaan.

Let op: Dit e-set van de systemen aan boord van hulp worden niet beïnvloed of gewijzigd wanneer een aanhangwagen.

**De Duitse tekst van deze handleiding is bindend.**

Wijzigingen voorbehouden.

**PL**

Proszę przestrzegać krajowych wytycznych dotyczących odbioru technicznego.

Wszelkie zmiany lub przebudowy instalacji elektrycznej są zabronione. Spowodują one utratę ważności świadectwa homologacji. Przed rozpoczęciem pracy należy przeczytać instrukcję montażu.

Ważne: Sprawdzić zawartość zestawu przed rozpoczęciem instalacji i zgłosić ewentualne odchylenia. Rozpocząć instalację jeżeli zestaw jest kompletny.

Instalacja elektryczna do haka holowniczego może zostać zamontowana wyłącznie przez firmę specjalistyczną. W przypadku nieprawidłowego montażu istnieje poważne ryzyko wypadku!

Firma Westfalia-Automotive nie ponosi odpowiedzialności za obrażenia oraz szkody materialne, wzgl. straty spowodowane instalacją lub nieprawidłowym montażem bądź użytkowaniem produktu.

Prace na poduszki powietrzne powinny być wykonywane wyłącznie przez odpowiednio przeszkolony personel.

Uwaga! Przed rozpoczęciem pracy należy sprawdzić pamięć błędów i w razie potrzeby zastosować urządzenie utrzymujące prąd ciągły. W przeciwnym razie może dojść do utraty danych elektronicznych. Odłączyć akumulator w celu uniknięcia uszkodzeń w instalacji elektrycznej pojazdu.

Nie przejmuje się żadnej odpowiedzialności z tytułu wprowadzania technicznych zmian i aktualizacji oprogramowania, które zostały dokonane np. przez producenta pojazdu od chwili pierwszego uruchomienia i które generują błędy podczas eksploatacji przyczepy.

Przewody nie mogą być zaciśnięte ani uszkodzone. Prawidłowo zamontować wszystkie elementy uszczelniające.

Podczas holowania przyczepy odłączone jest tylne światło przeciwmgielne.

Adapter gniazda może być używany tylko podczas holowania przyczepy.

- Awaria kierunkowskazów przyczepy sygnalizowana jest na desce rozdzielczej przez szybciej migającą kontrolkę.

Funkcje przyczepy należy sprawdzić z podłączoną przyczepą lub za pomocą przyrządu kontrolnego z opornością obciążenia.

Uwaga! Należy się upewnić, że zostały spełnione wszystkie wymagania producenta pojazdu dotyczące zmian i doposażania pojazdu i/lub systemu chłodzenia w celu eksploatacji z przyczepą.

Uwaga: Ten adres e-Ustaw pokładowe systemy pomocy nie są naruszone lub zmienione podczas holowania przyczepy.

**Tekst niniejszej instrukcji w języku niemieckim jest wiążący.**

Zmiany zastrzeżone.

**RUS**

Подлежат соблюдению национальные директивы о порядке приемки навесного/встраиваемого оборудования.

Какие-либо изменения и переделки на электрооборудовании недопустимы. Они делают недействительным разрешение на эксплуатацию.

Перед началом работы прочтите инструкцию по монтажу.

Важно: Проверить содержимое набора перед началом установки и сообщить в случае отклонений. Начинать установку только при наличии полного набора.

К монтажу электрооборудованию сцепного устройства допускаются только специализированные фирмы. При неправильном монтаже грозит опасность тяжелых травм!

Westfalia-Automotive не несет ответственности за ущерб, причиненный людям или имуществу, и соотв. за убытки, причиной которых стали ошибки при установке, монтаже или использовании продукта.

Работа над подушками безопасности должны выполняться только надлежащим образом обученным персоналом.

Внимание – перед началом работы прочтите содержимое накопителя сбоев, при необходимости воспользоваться источником бесперебойного питания во избежание потери сохраненных данных в электронных устройствах. Отсоединить батарею, чтобы предотвратить повреждение электроники автомобиля.

Гарантийные претензии не принимаются в случае технических изменений, обновлений ПО, которые были произведены после первичной приёмки в эксплуатацию, например, производителем автомобиля и привели к неправильной работе прицепа.

Не допускать заземления и повреждения электропроводки. Все уплотнения устанавливать как положено.

При пользовании прицепом отключать на тягаче заднюю противотуманную фару.

Пользоваться розеточным переходником только при работе с прицепом.

- Отказ мигалок прицепа отображается в кабине учащенным миганием.

Проверку работы прицепа вести с самим прицепом или пробником с нагрузочными сопротивлениями.

Внимание! Необходимо удостовериться, что выполнены все требования производителя автомобиля по изменениям и дополнительному оснащению автомобиля и/или системы охлаждения для эксплуатации с прицепом.

Пожалуйста, обратите внимание: этот адрес электронной установить системы на борту помощь не влияет или изменены при буксировке прицепа.

**Обязательным является немецкий текст данной инструкции.**

Право на внесение изменений сохраняется.

Nationella riktlinjer beträffande monteringen skall beaktas.

All form av ändring respektive ombyggnad på elsystemet är förbjuden. Förändringar resulterar i att körtillståndet upphör att gälla. Läs igenom monteringsanvisningarna innan arbetet påbörjas.

Viktigt: Kontrollera setets innehåll innan du börjar med installationen och rapportera i förekommande fall avvikelser. Börja med installationen först när du har ett komplett set.

Elsystemet för dragkroken får endast monteras av kvalificerade tekniker. Vid felaktig montering föreligger risk för allvarliga olyckor!

Westfalia-Automotive tar inte ansvar för personskador eller materiella skador resp. förluster, som förorsakats av installationen eller en felaktig montering eller användning av produkten.

Arbete på krockkuddar bör endast utföras av utbildad personal.

Obs – innan arbetet påbörjas, läs av felminnet och använd vid behov enheten för bibehållning av vilostrom, annars kan elektroniskt sparade data gå förlorade. Frånkoppla batteriet för att undvika skador på fordons elektronik.

Ingen garanti ges för tekniska ändringar, programuppdateringar, som genomförs efter idrifttagningen för första gången, t.ex. av fordonstillverkaren och som leder till felfunktioner vid användningen av släpet.

Ledningarna får inte vara klämda eller skadade. Montera alla tätningselement korrekt.

När släpvagnen är påhängd släcks dragfordonets dimbakljus.

Stickdosadaptern får bara användas i kombination med släpvagn.

- Om blinkerljusen på släpvagnen är ur funktion, visas detta genom att lampan i instrumentpanel blinkar snabbare än normalt.

Släpvningsfunktionerna ska kontrolleras med hjälp av en påhängd släpvagn eller en provningsutrustning med belastningsmotstånd.

Observera! Det skall säkerställas att samtliga krav från fordonstillverkaren gällande ändringar på och kompletteringsutrustning av fordonet och/eller kylsystemet för användning med släp har genomförts.

Observera: Den här e-set ombord assistanssystem påverkas inte eller ändras vid körning med släpvagn.

**Den tyska texten i denna anvisning är bindande.**

Ändringar förbehålls.

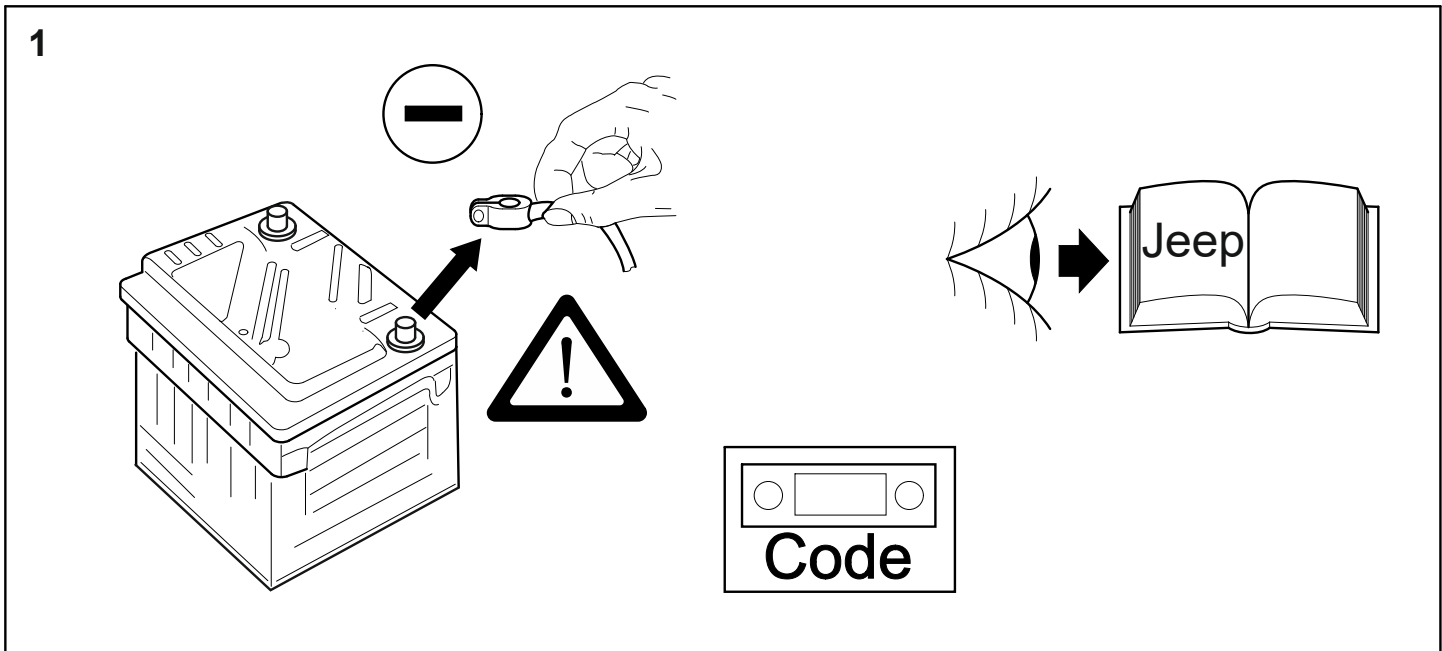
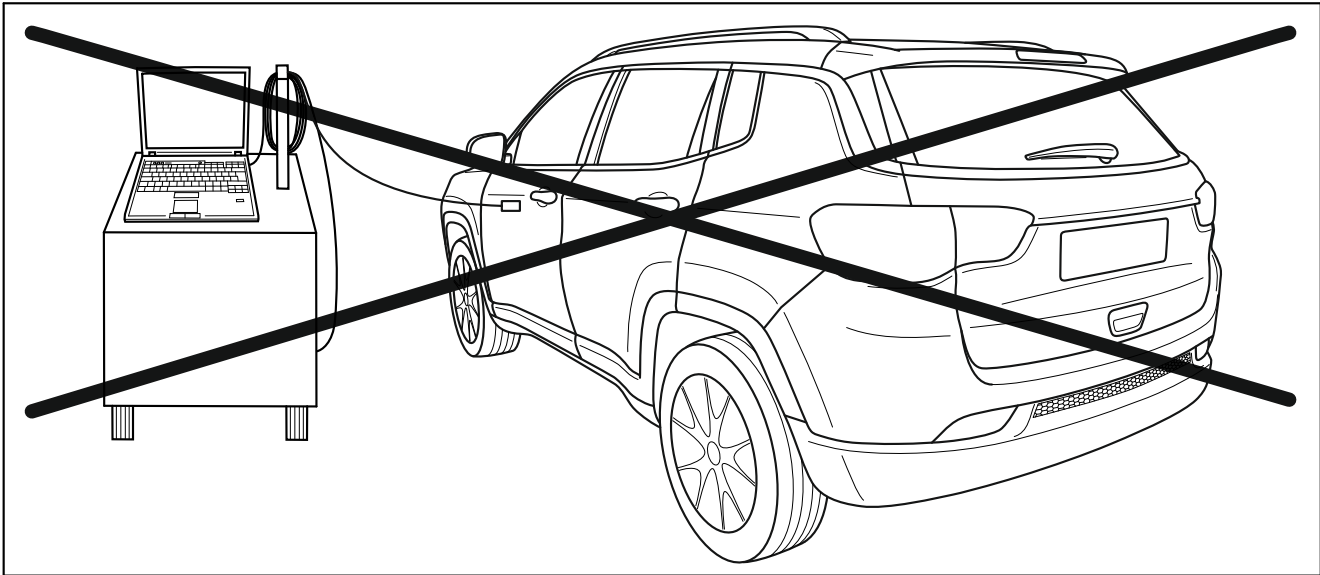
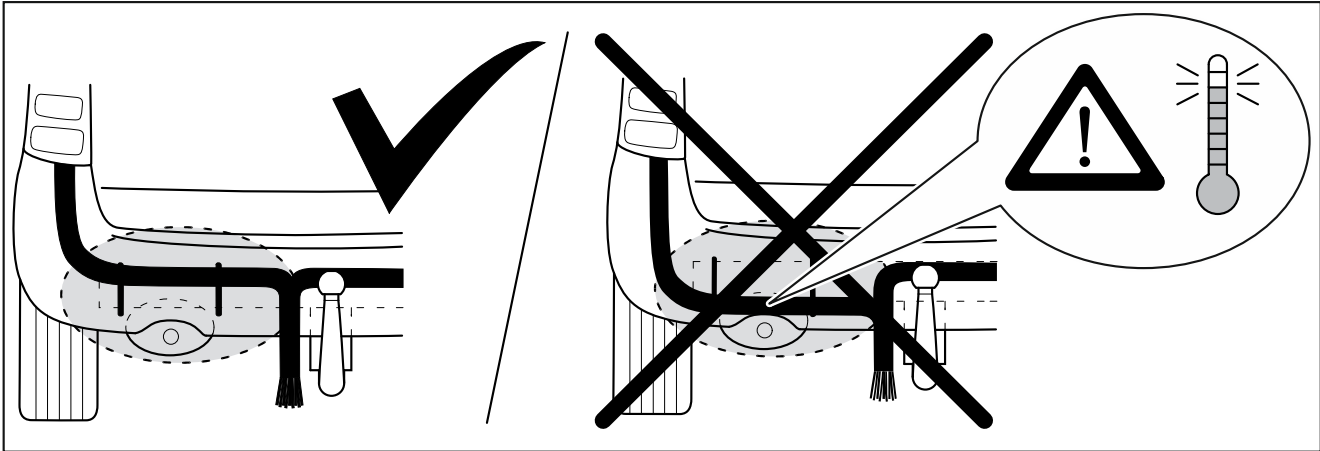
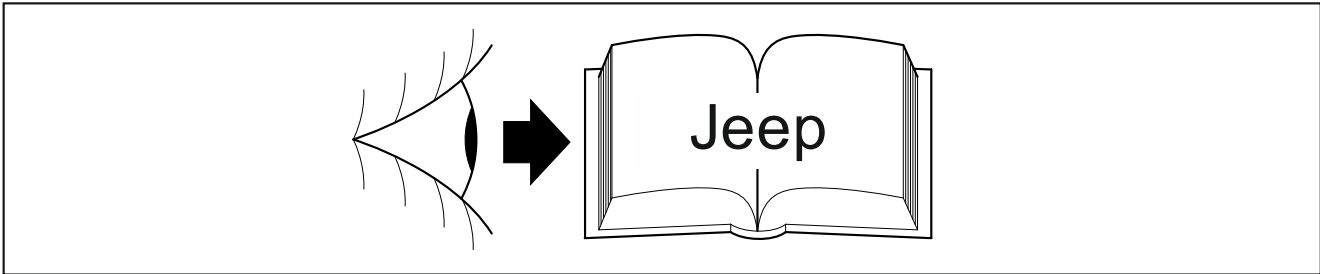



2

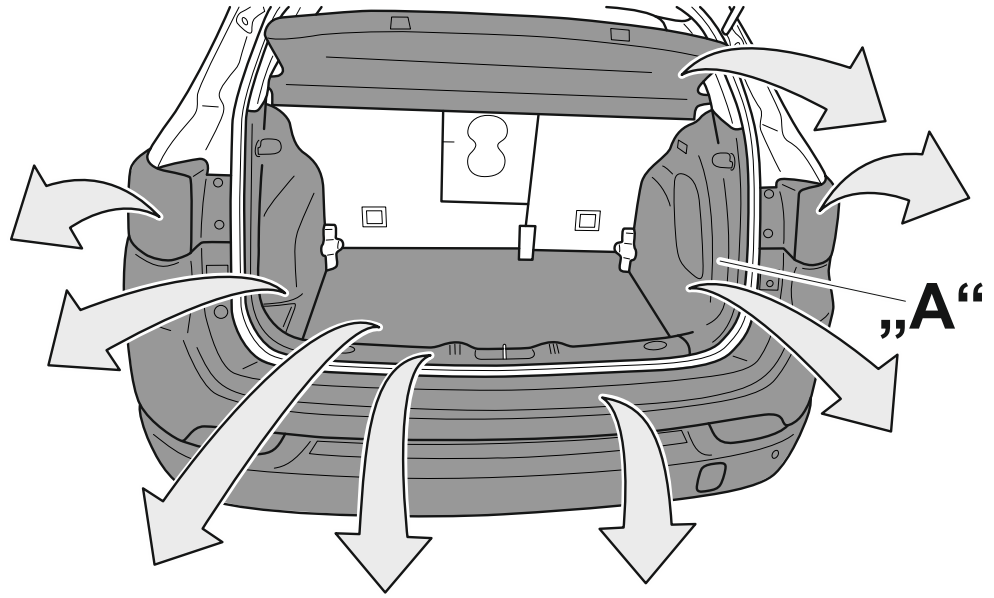
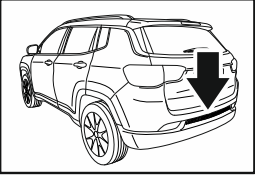

3

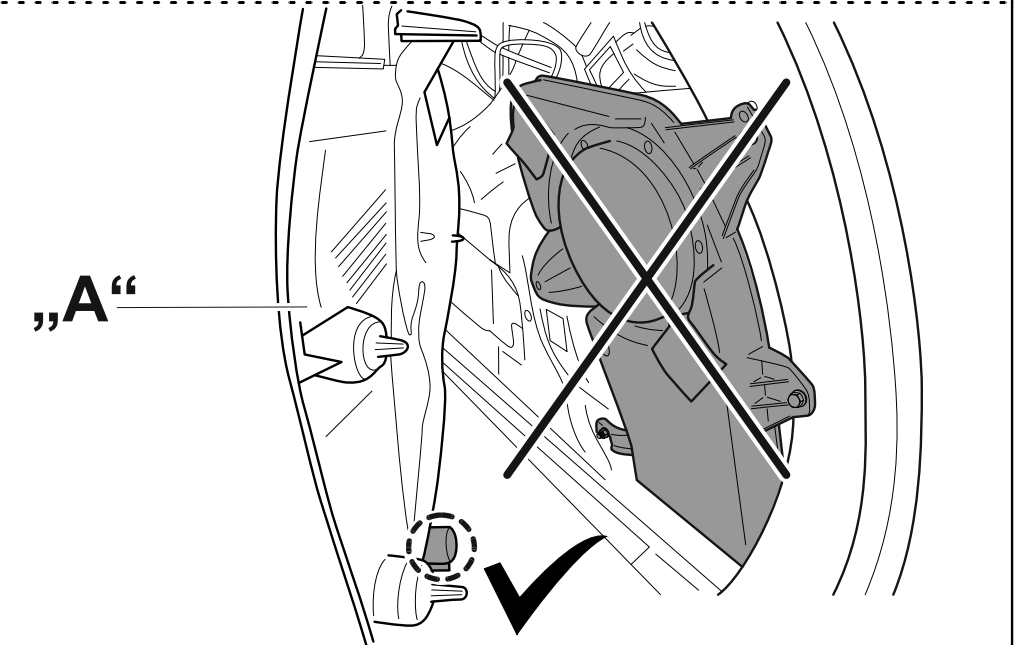
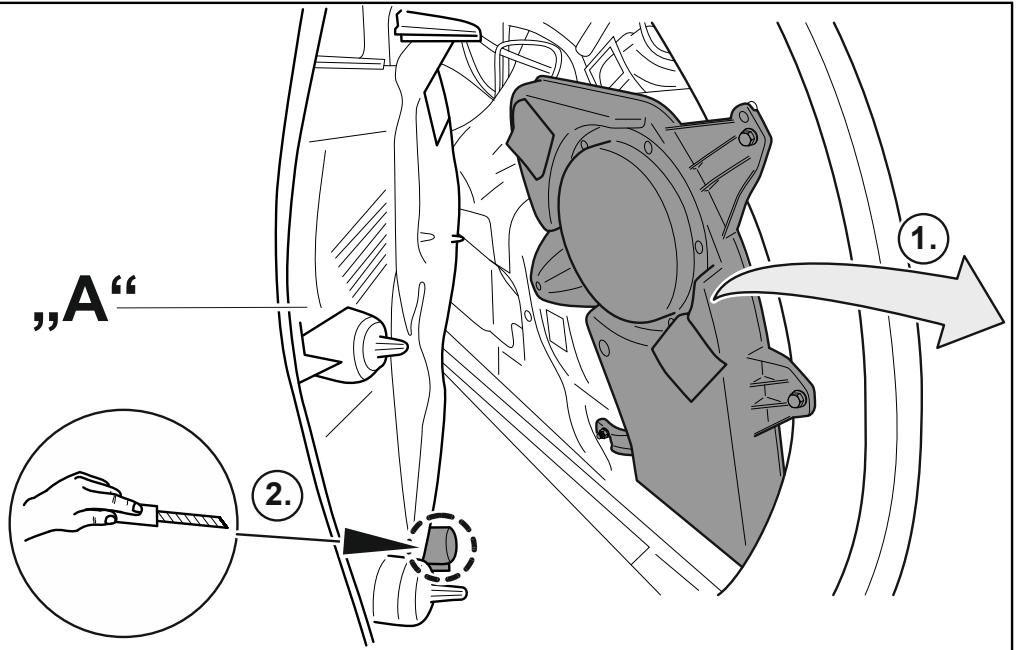
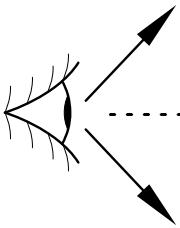
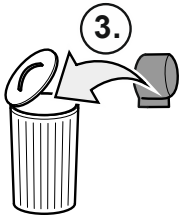
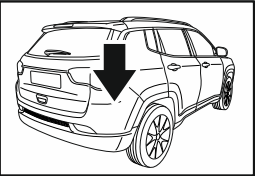

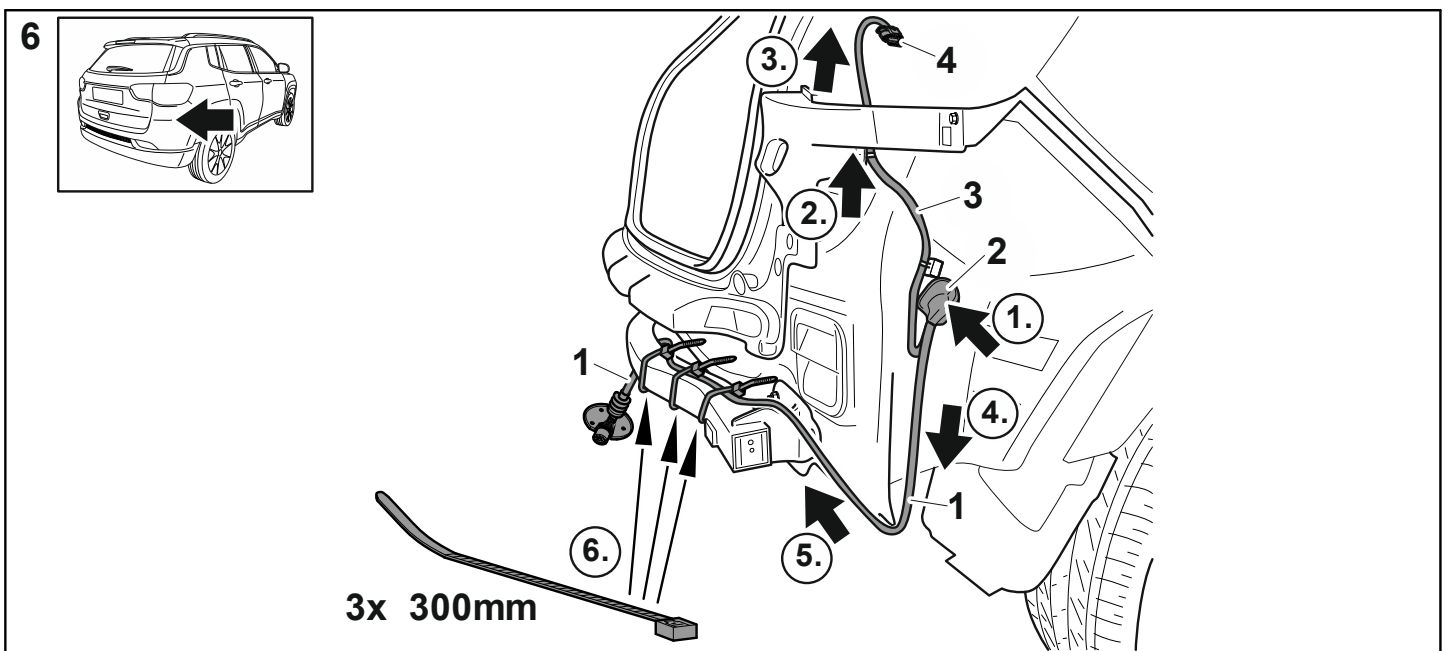
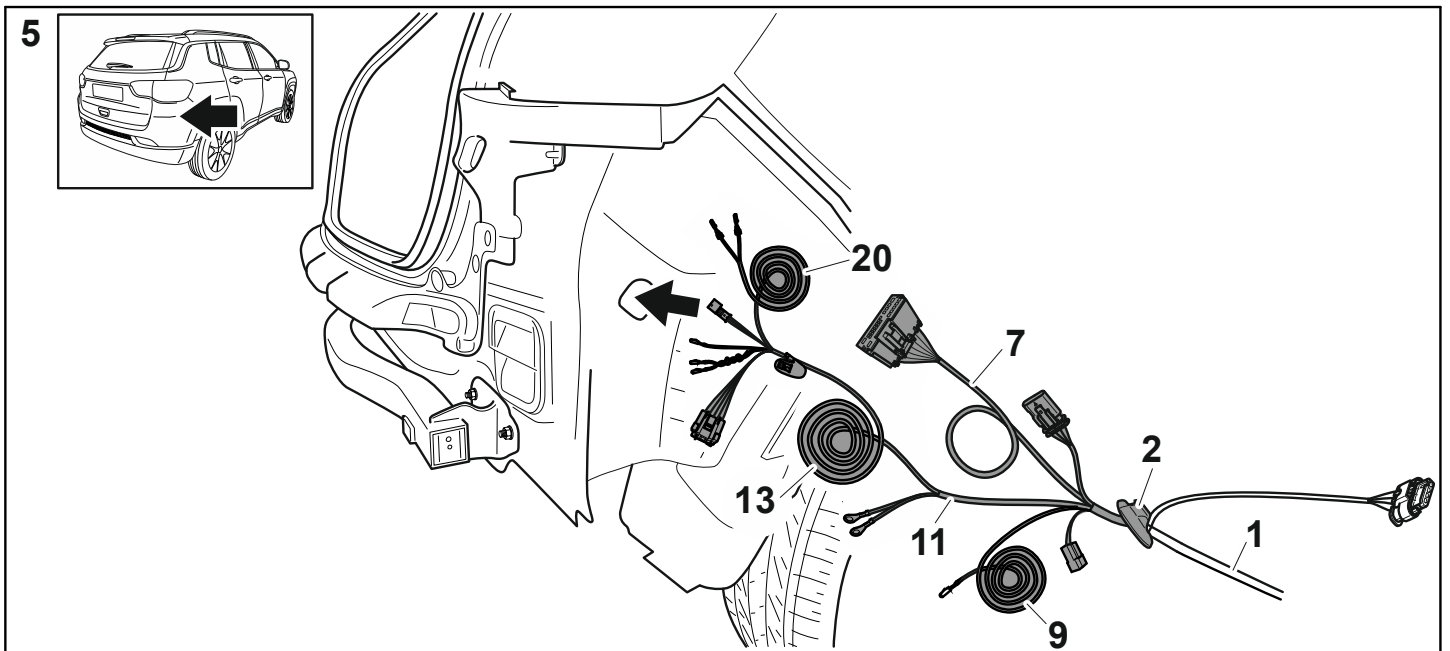
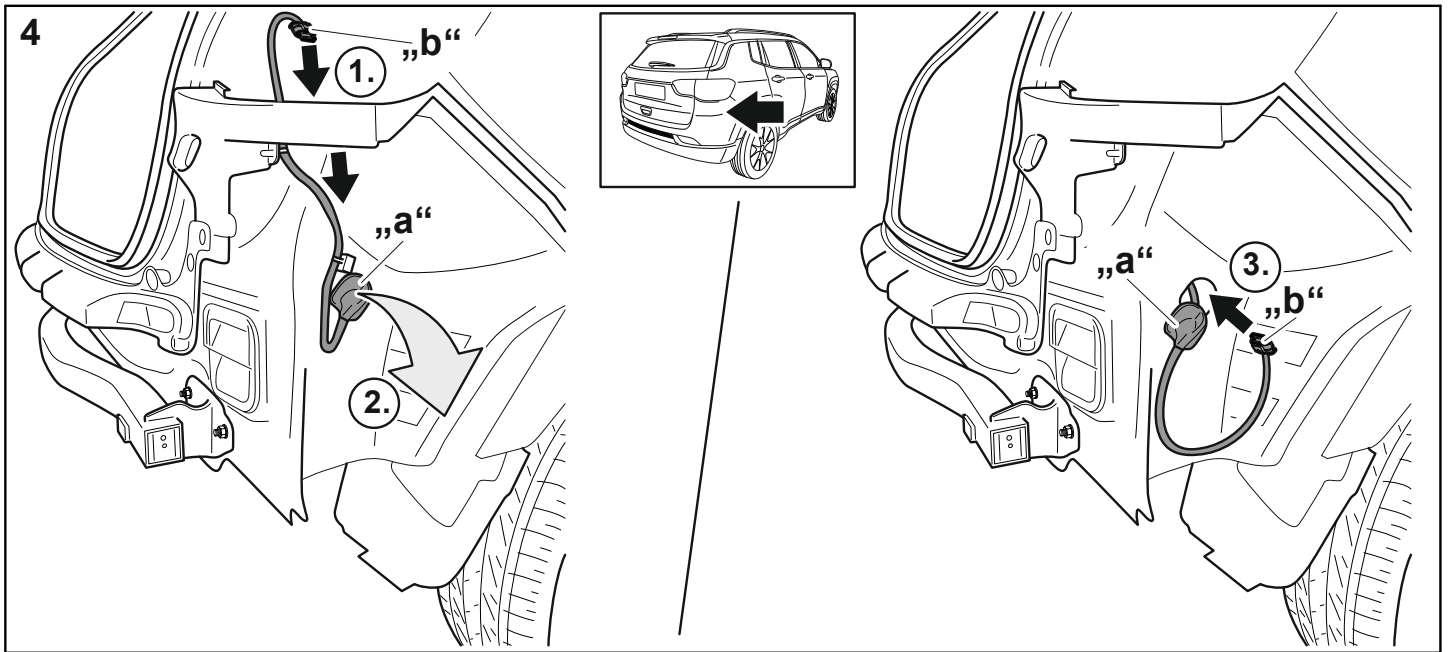

7

- 3x M5x35 
- 3x M5x25 
- 3x M5 
- 3x B5 

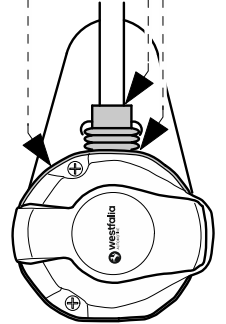
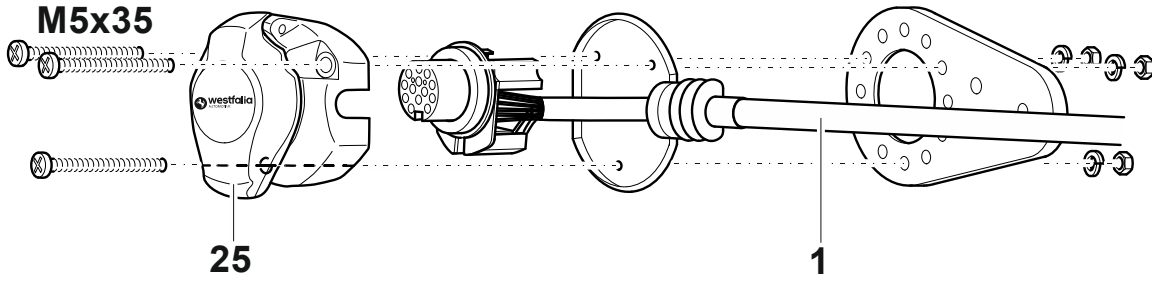

8

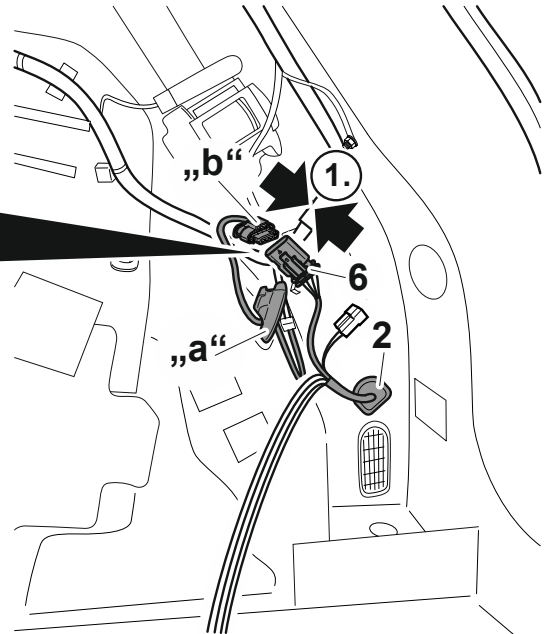
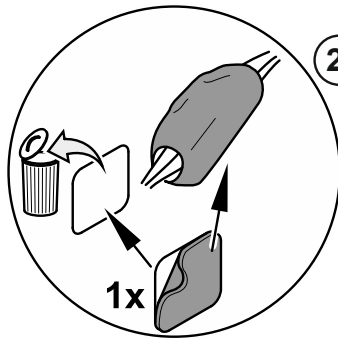
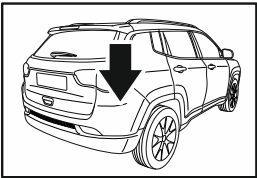

9

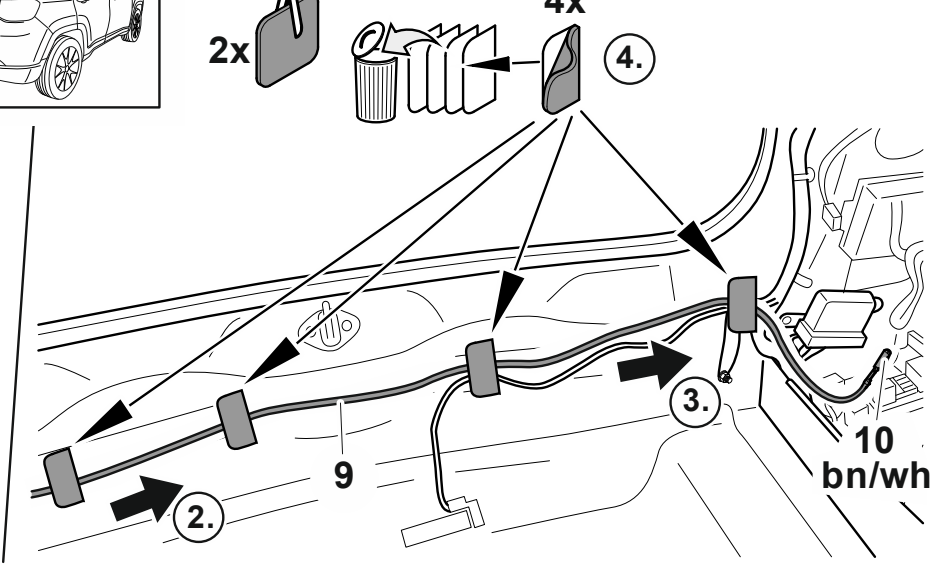
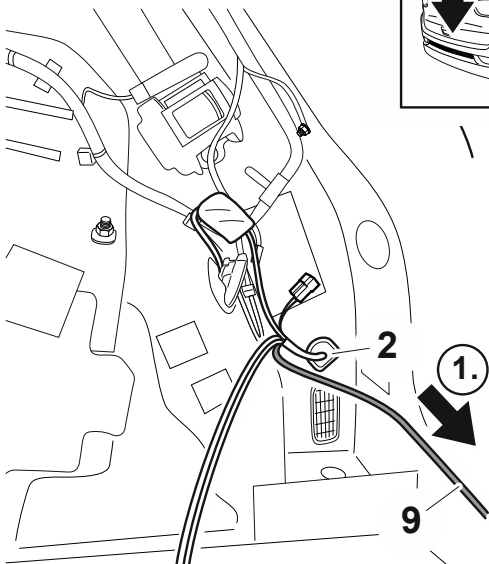
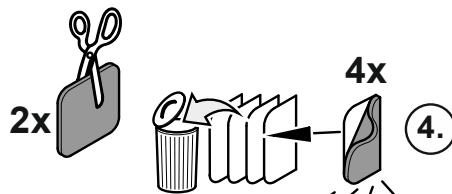
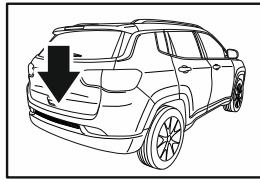

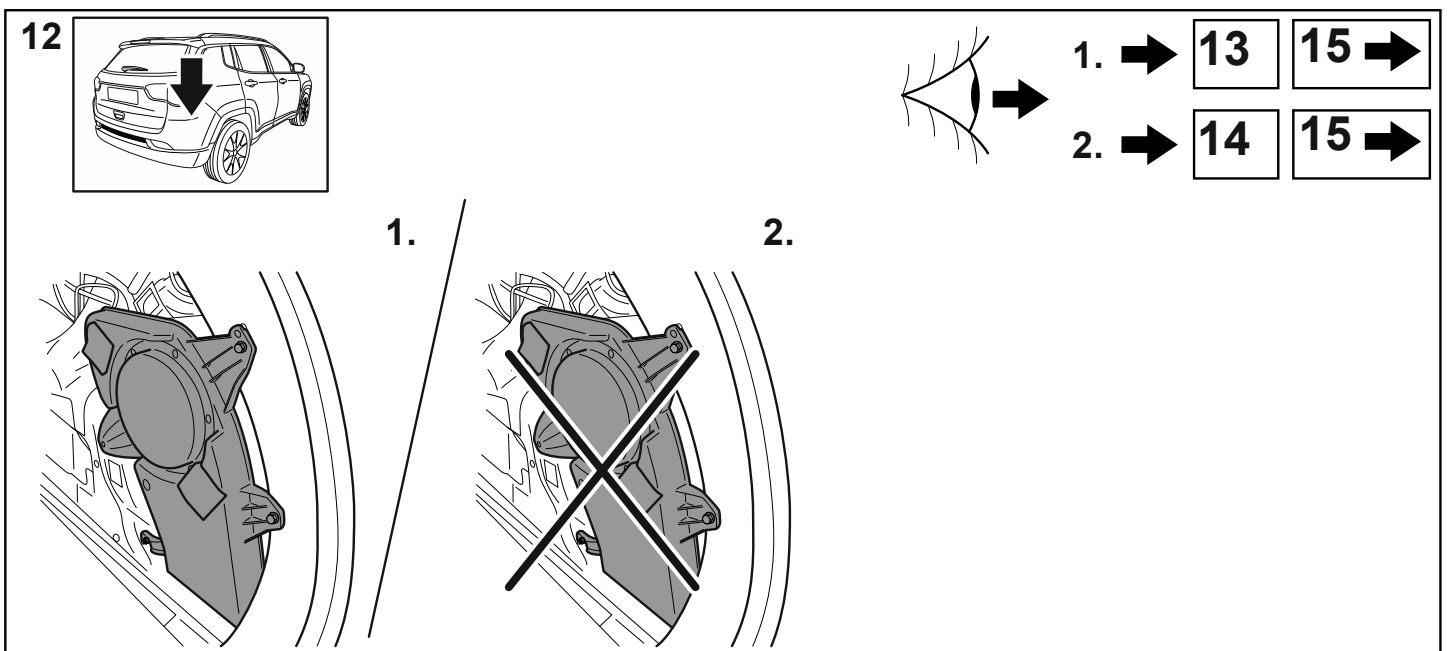
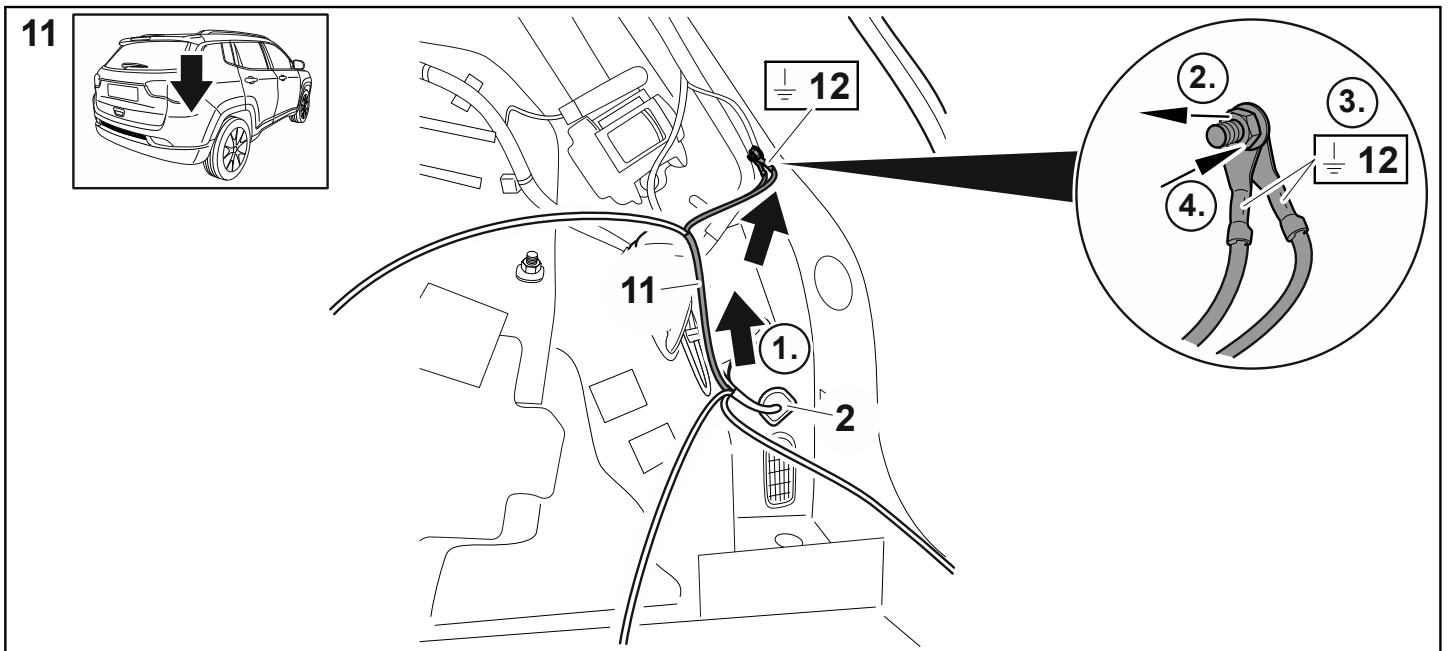
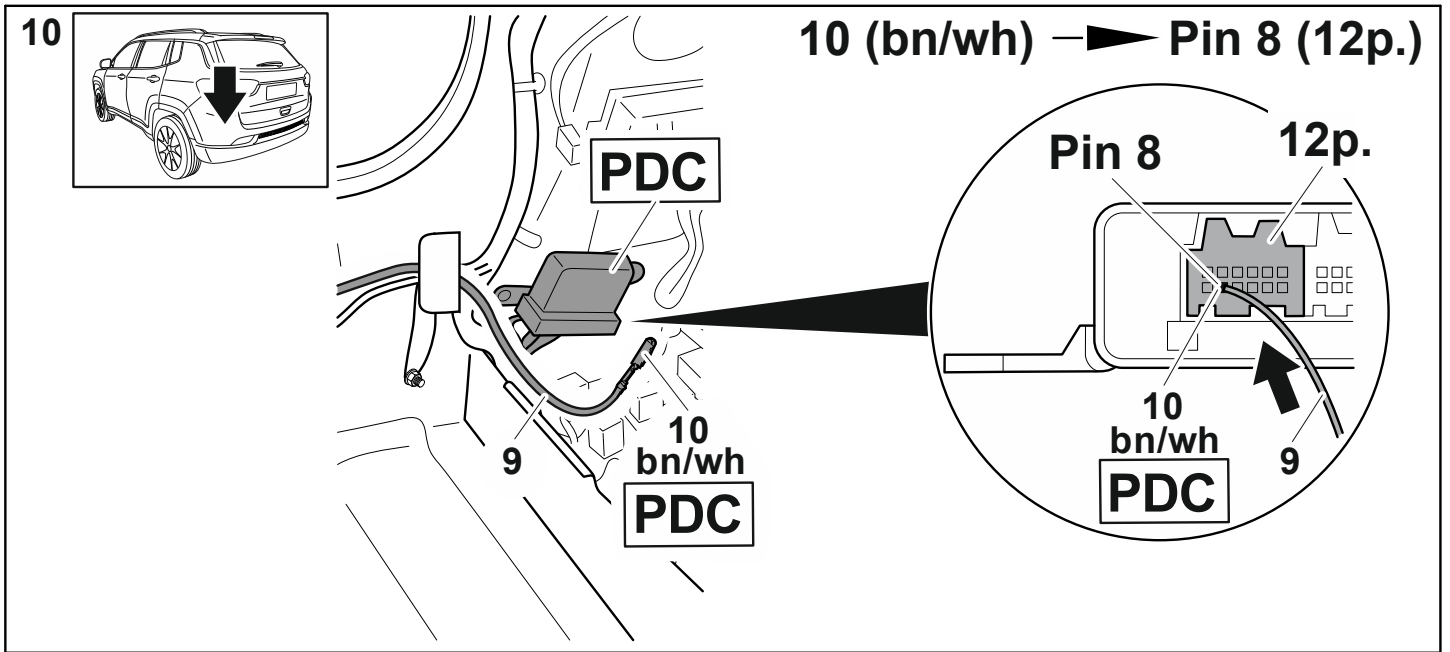

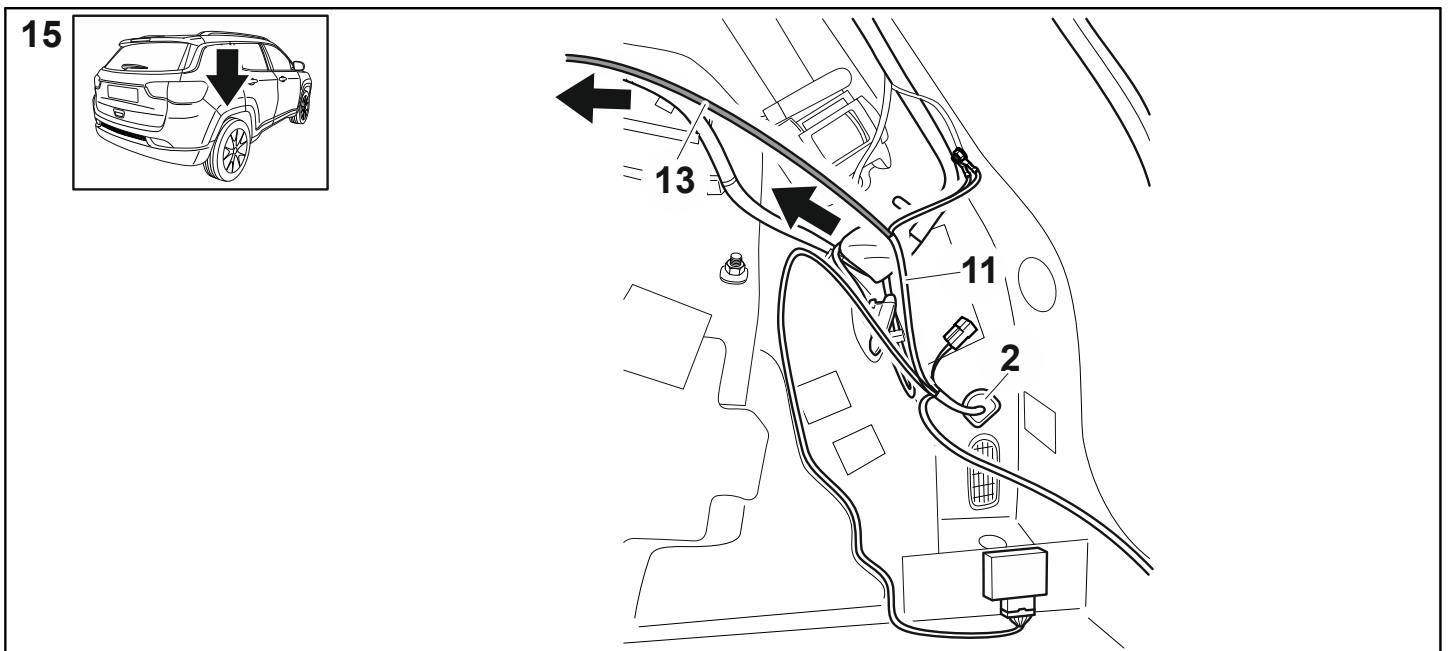
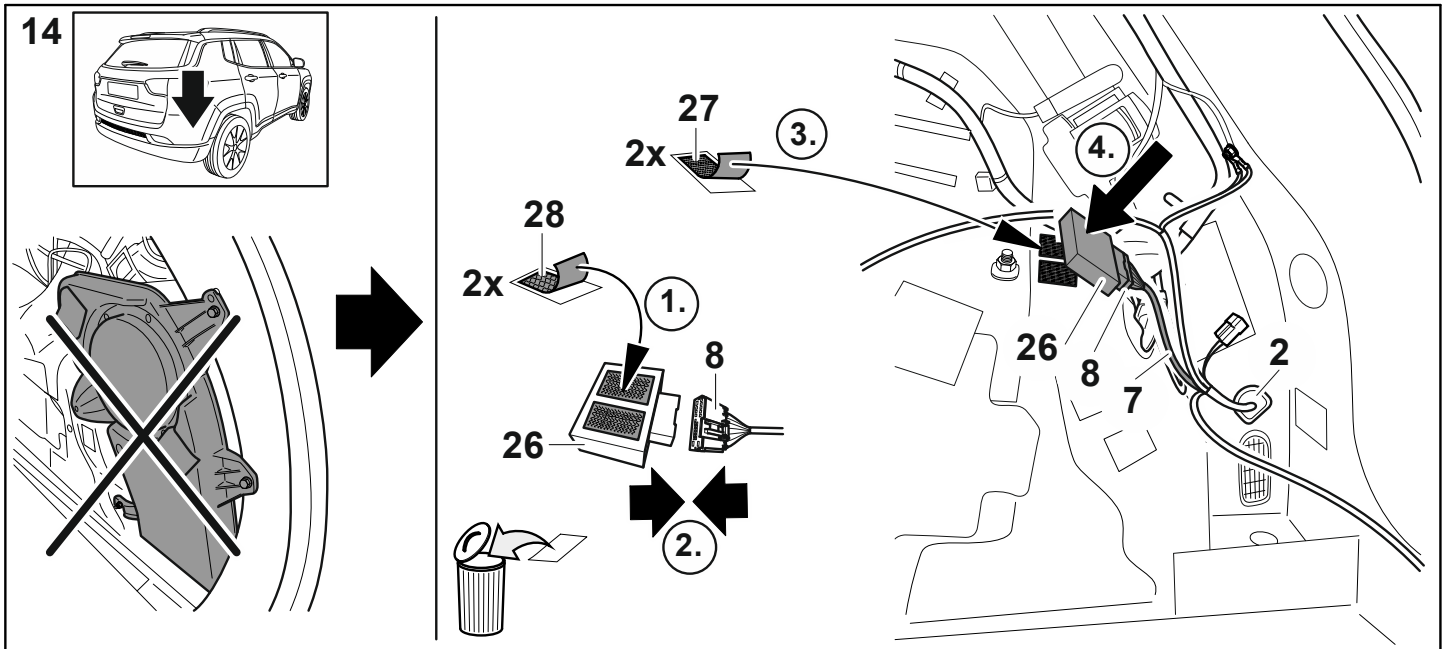
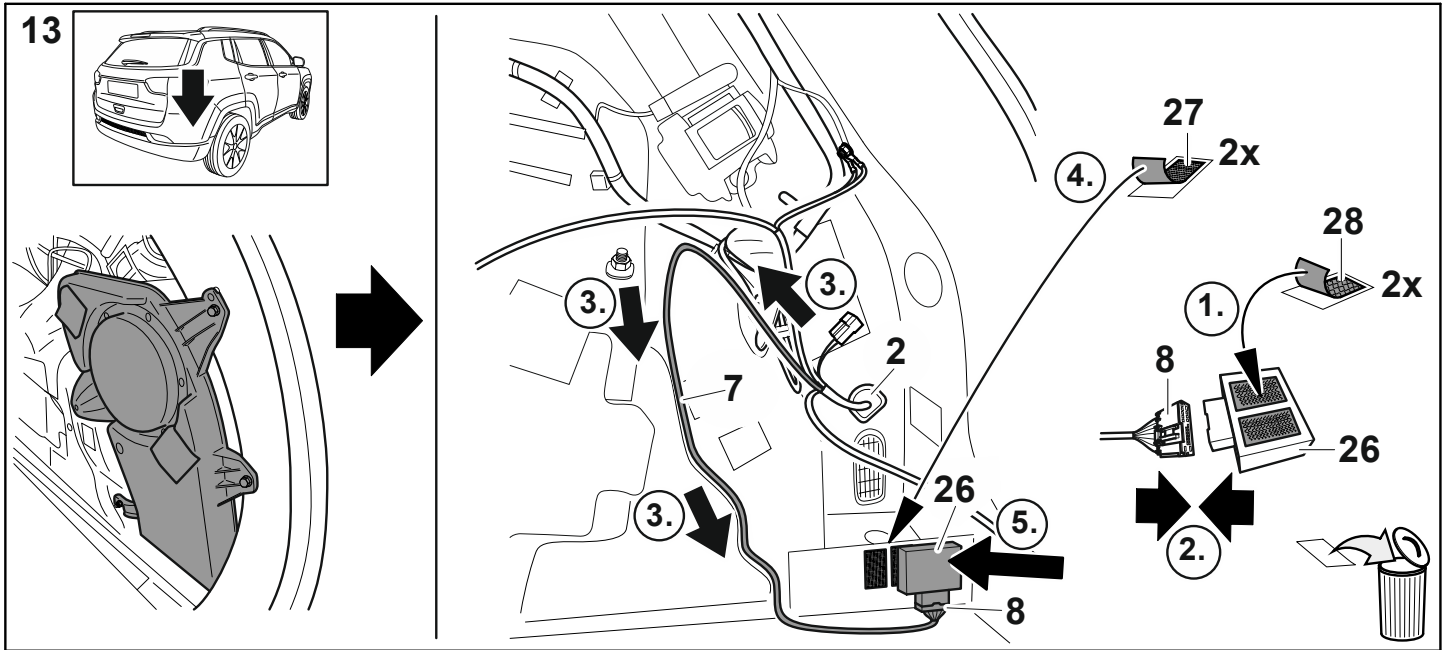

16

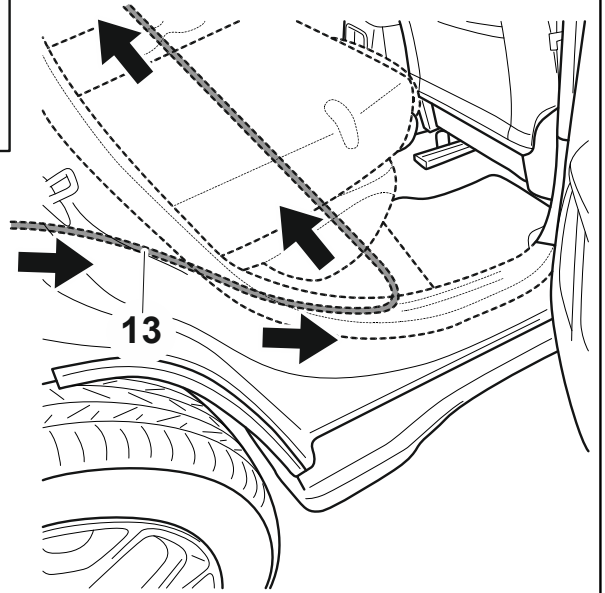
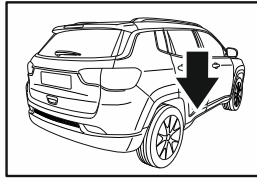
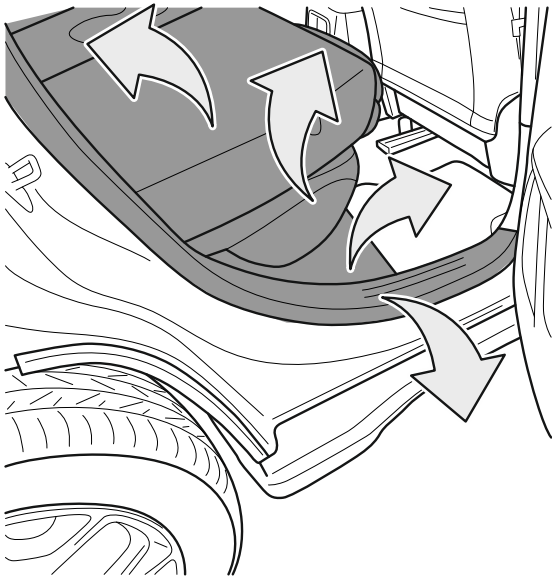

17

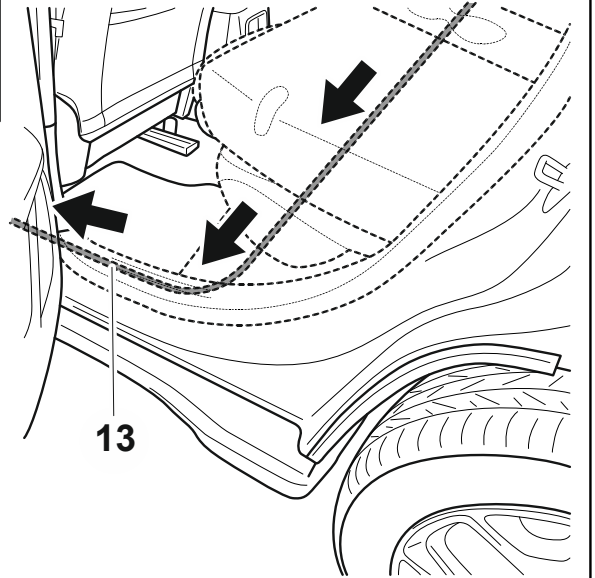
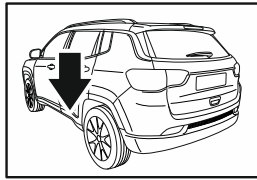
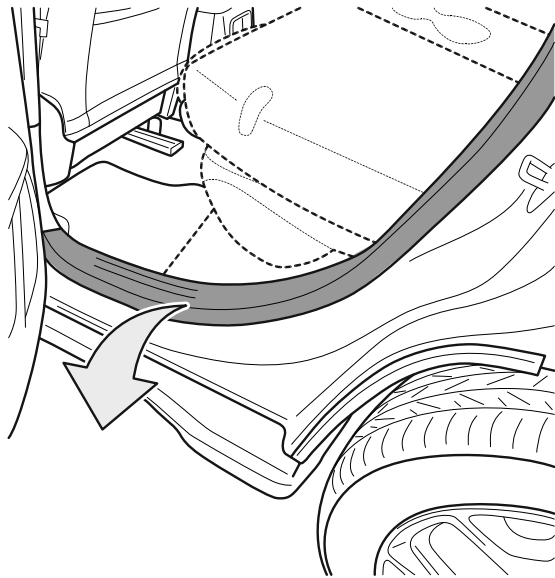

18

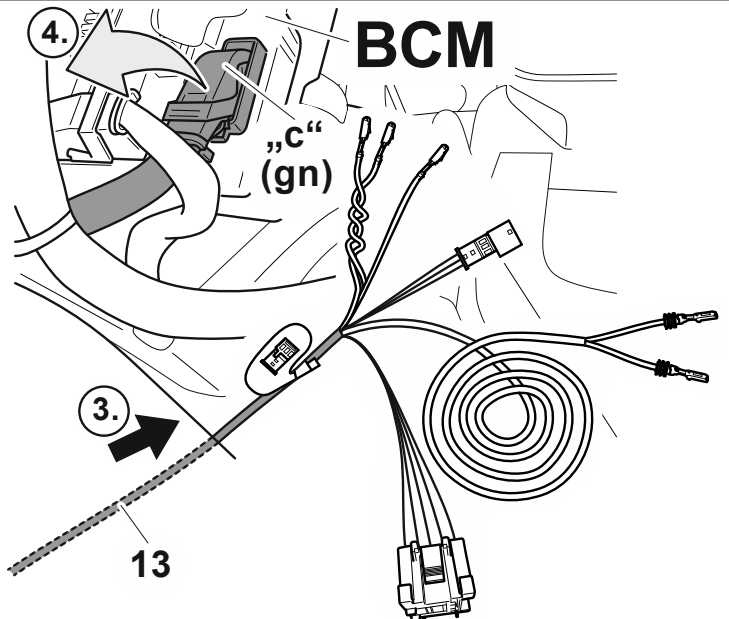
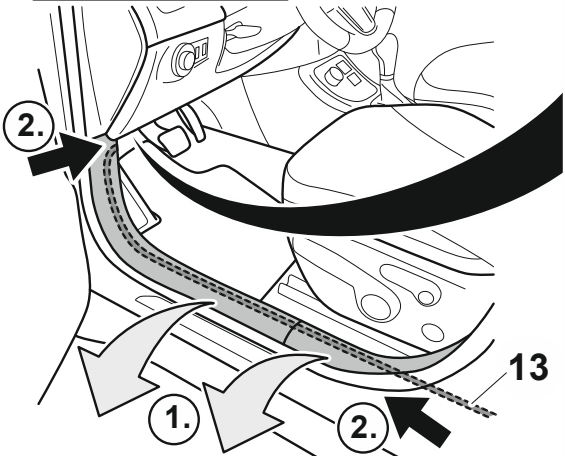
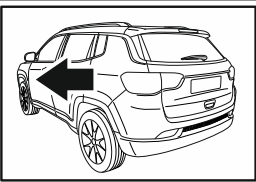

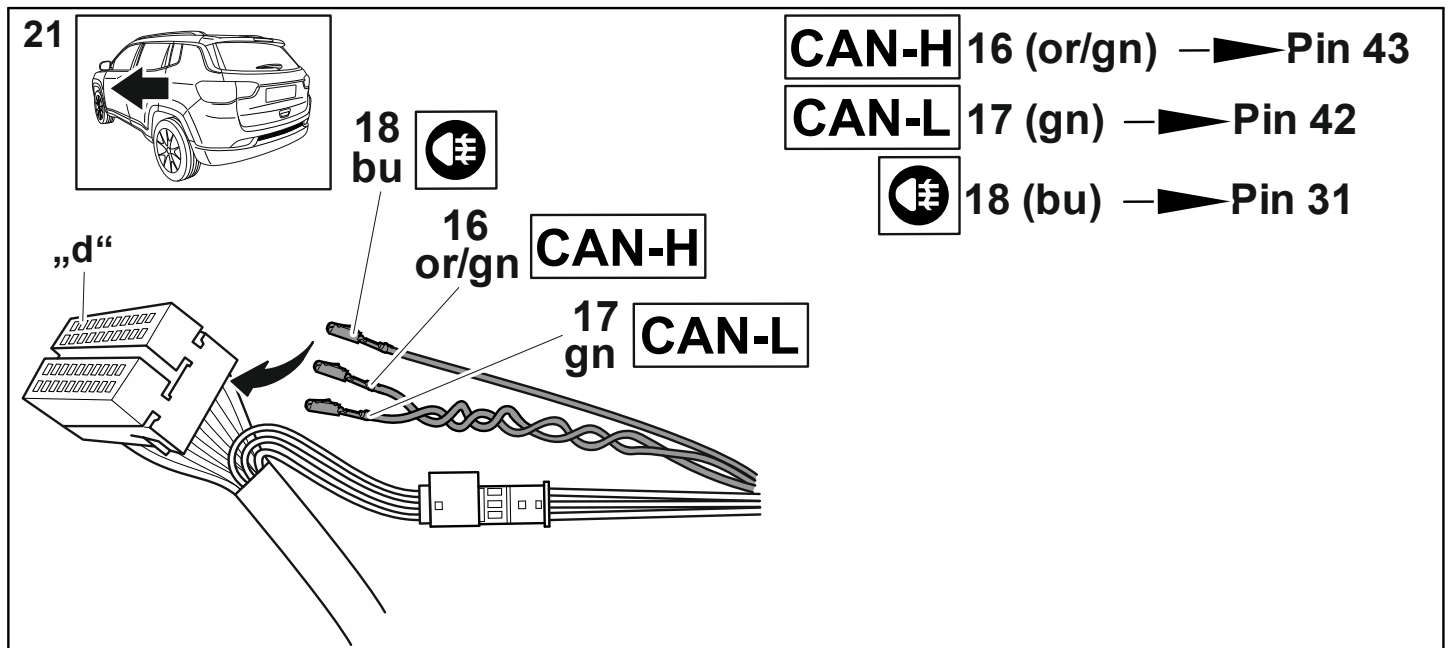
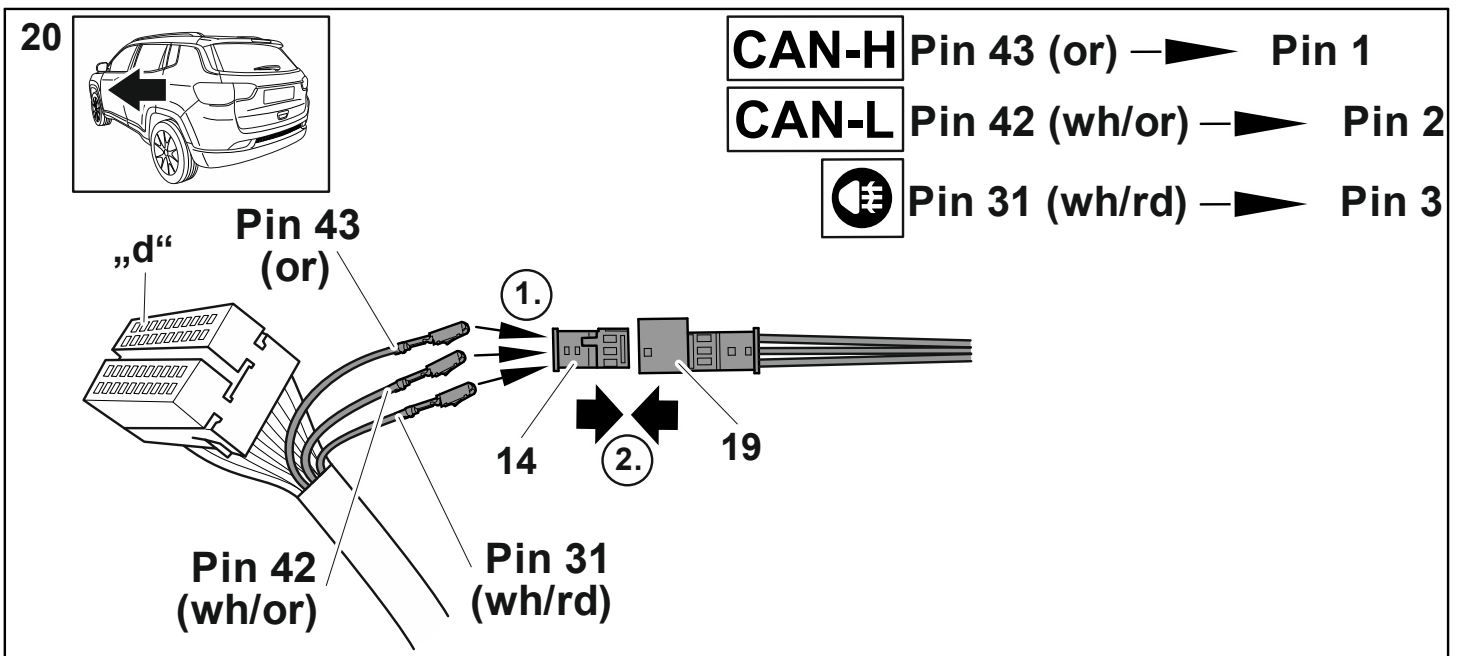
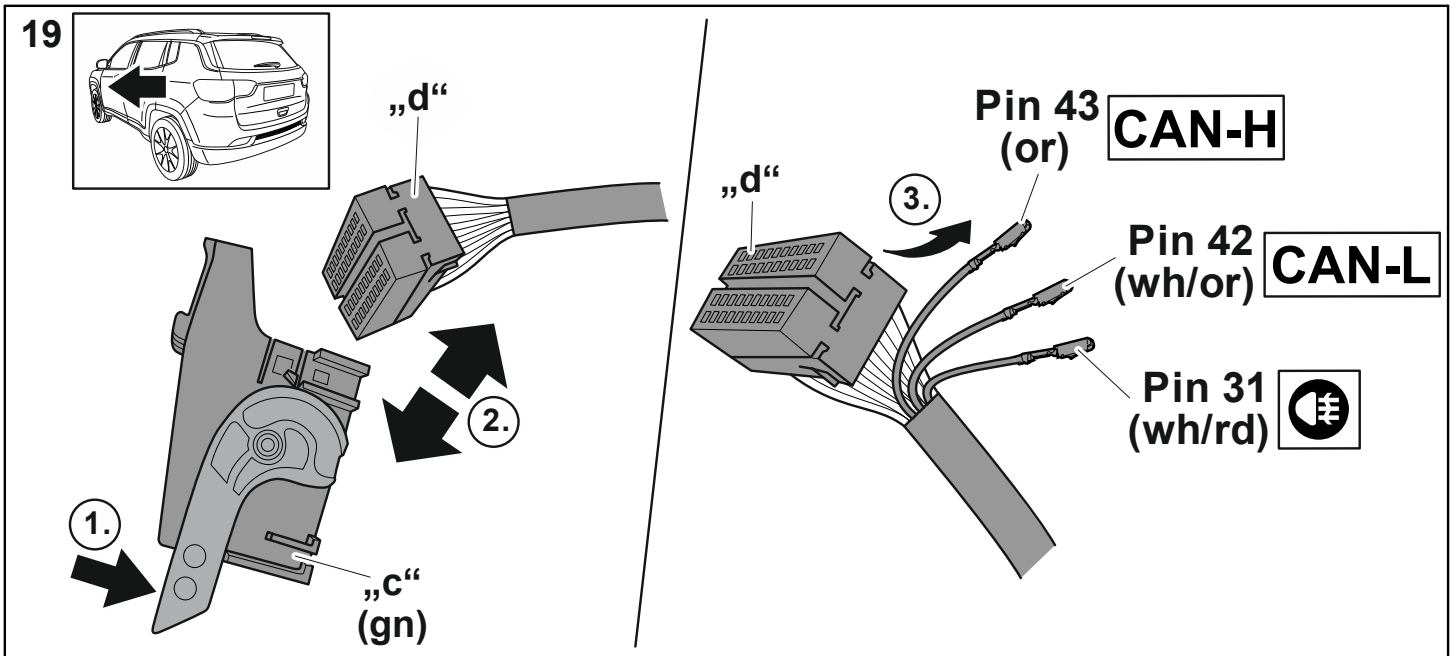

22

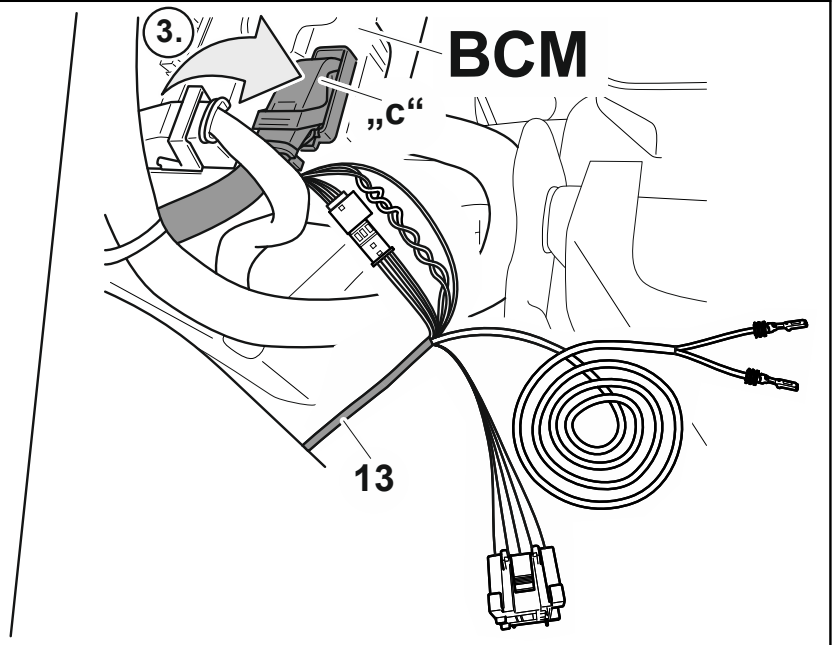
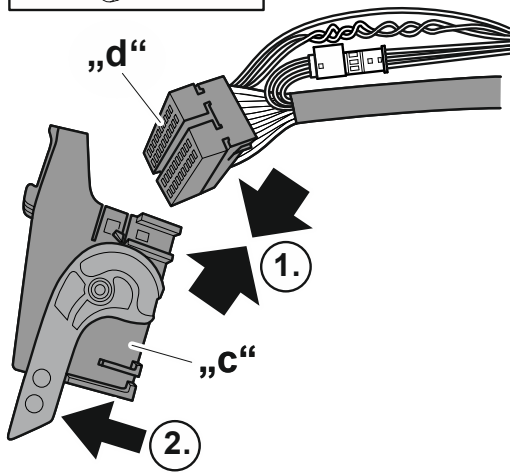
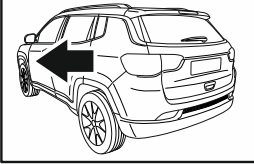

23

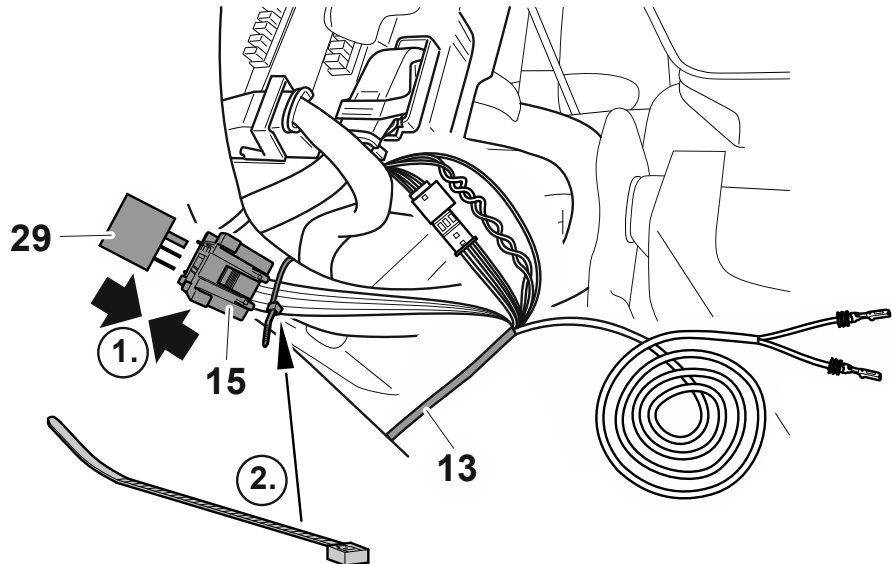
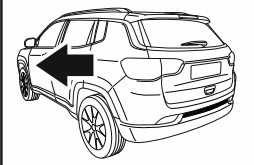

24

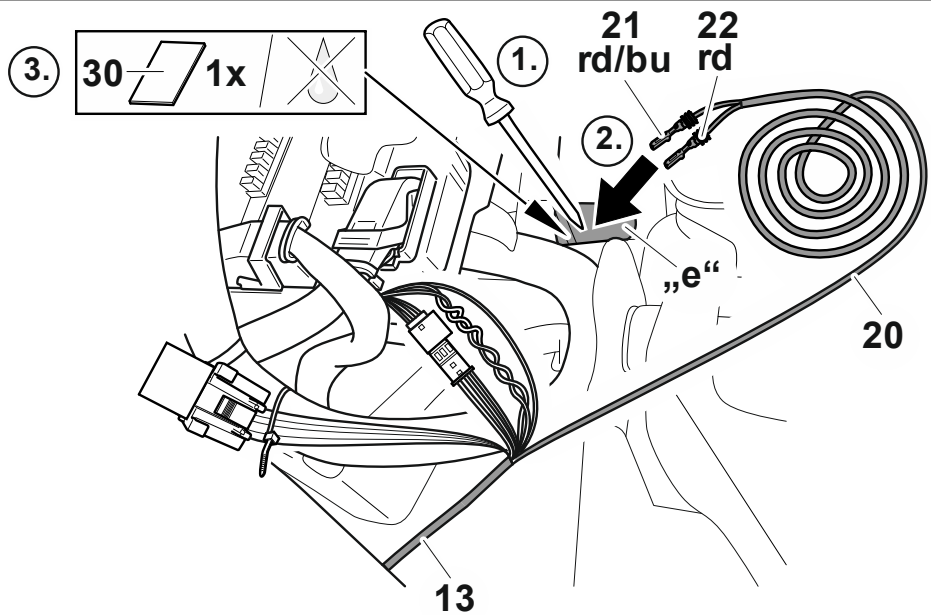
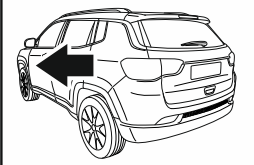



25

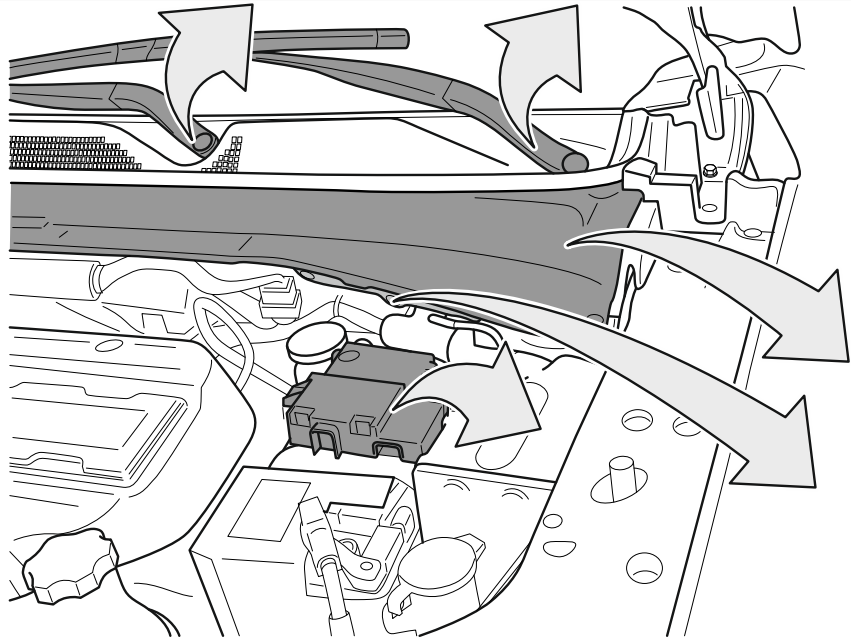
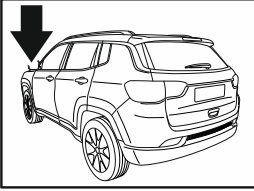

26

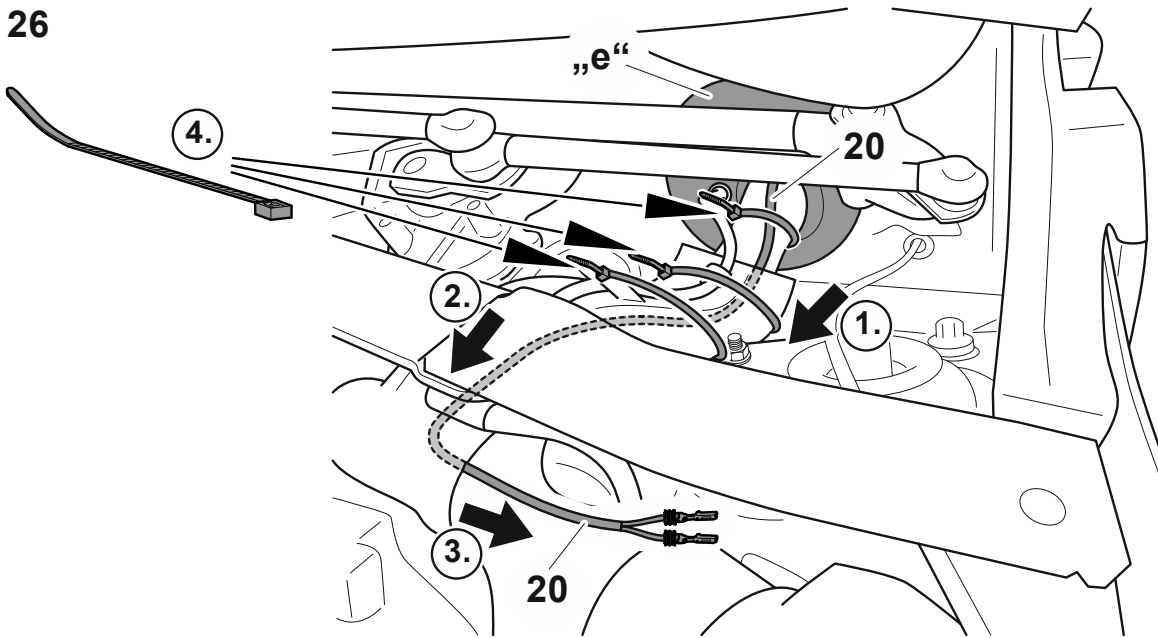
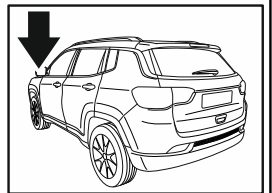

27

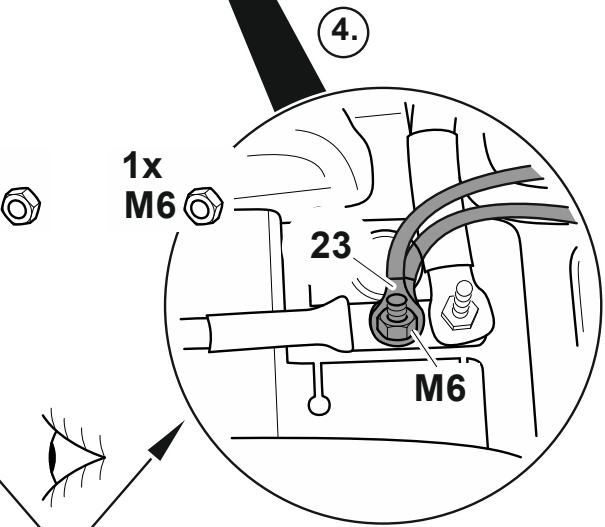
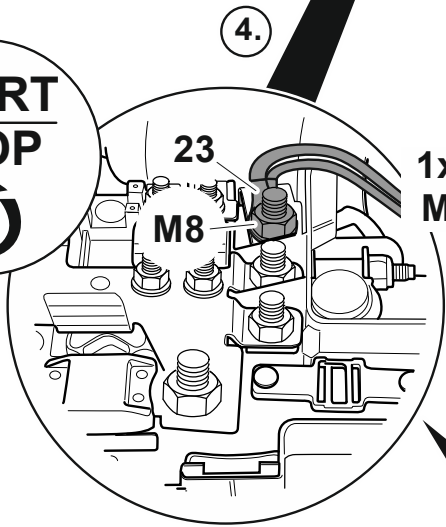
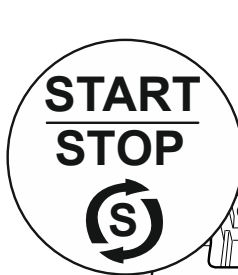
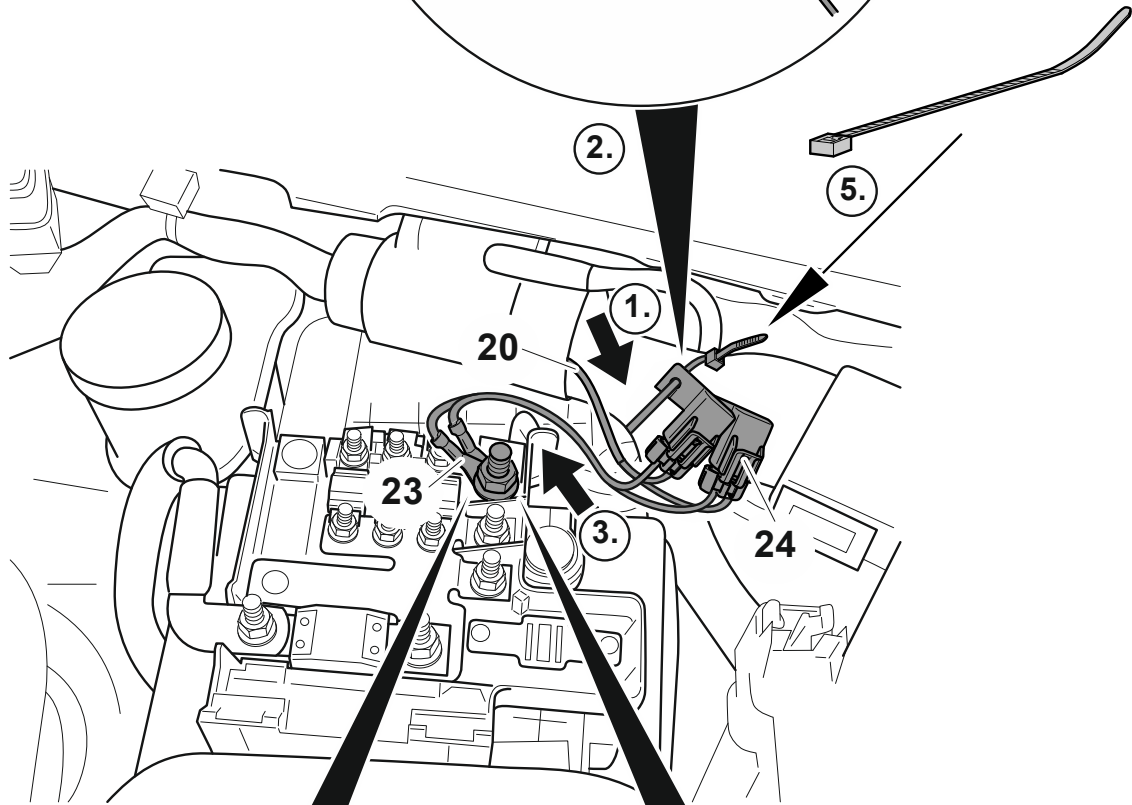
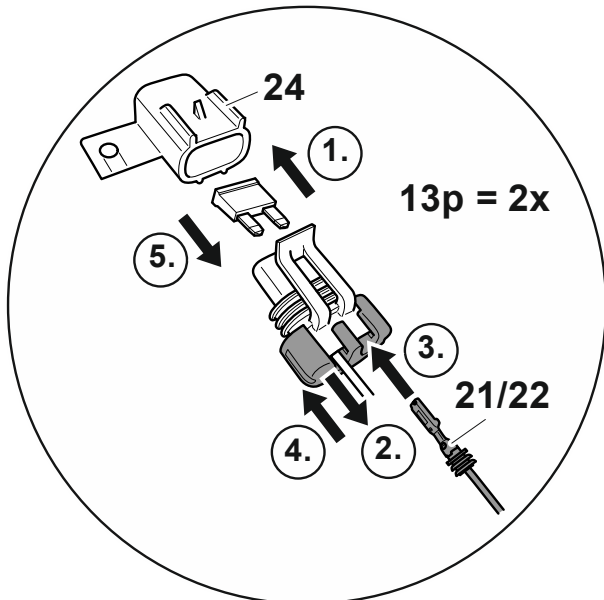
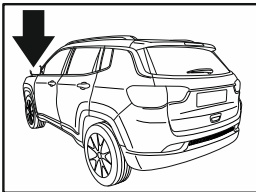

28

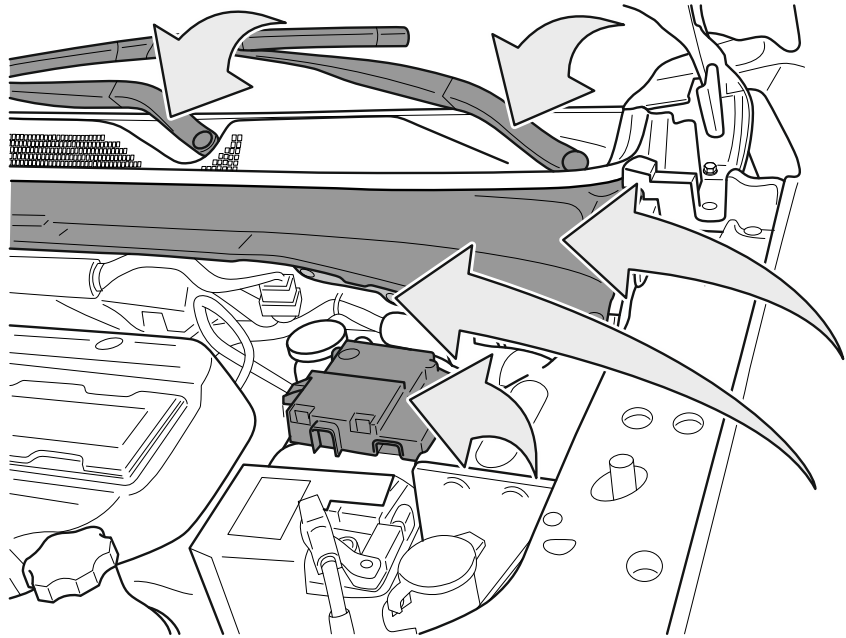
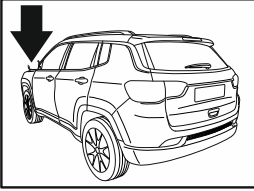

29

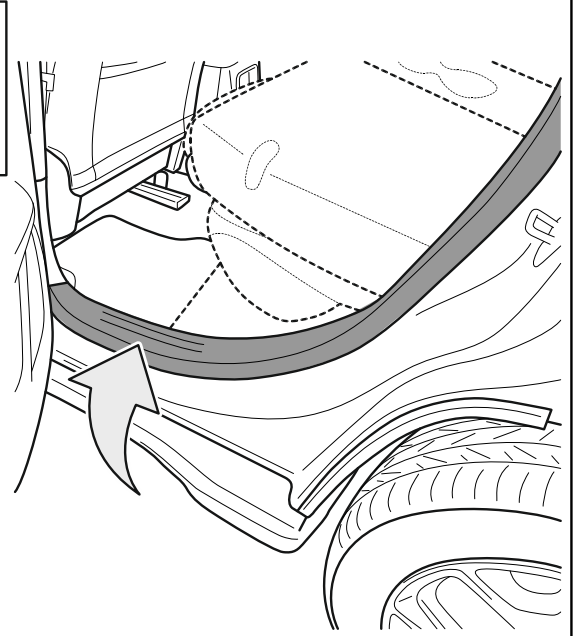
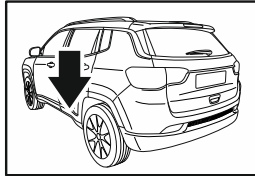
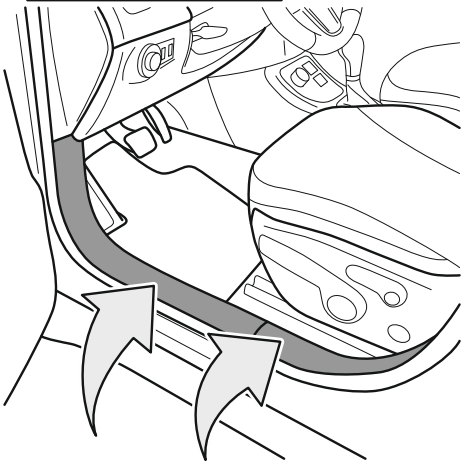
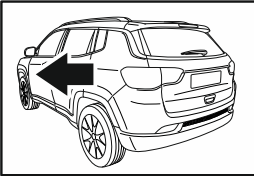

30

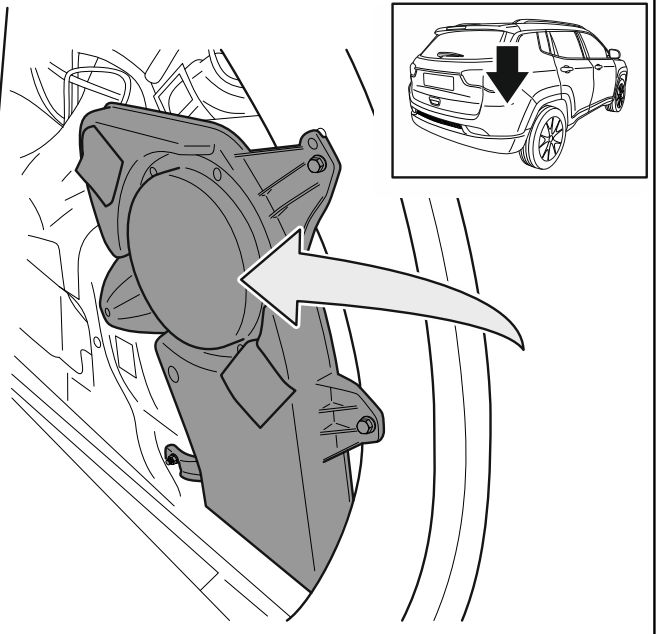
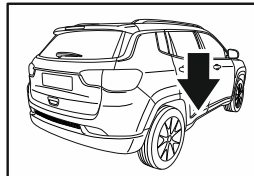
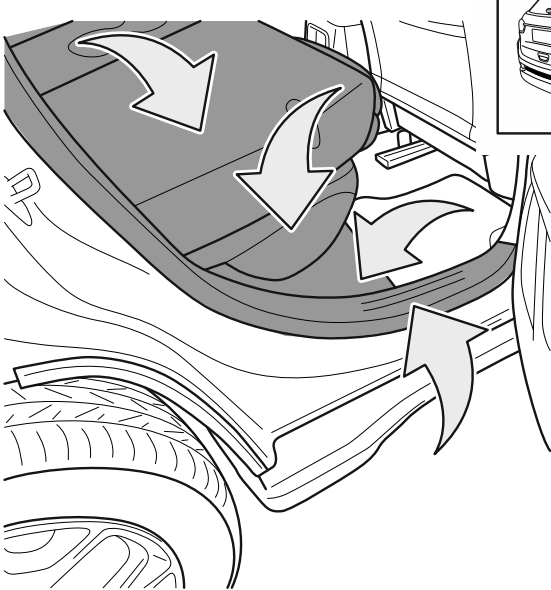

31

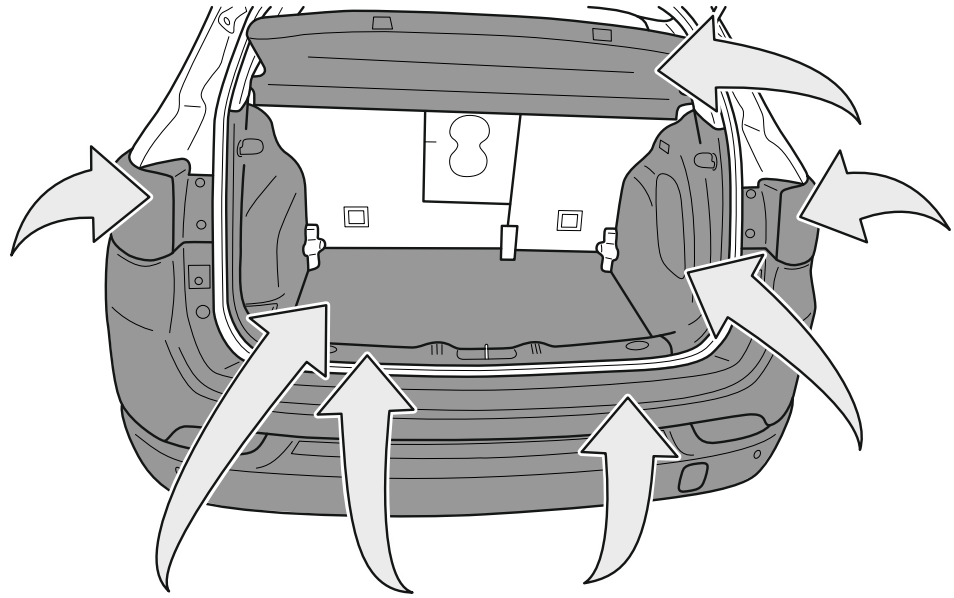
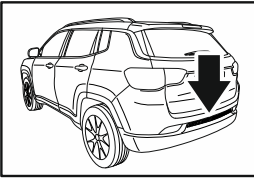

32

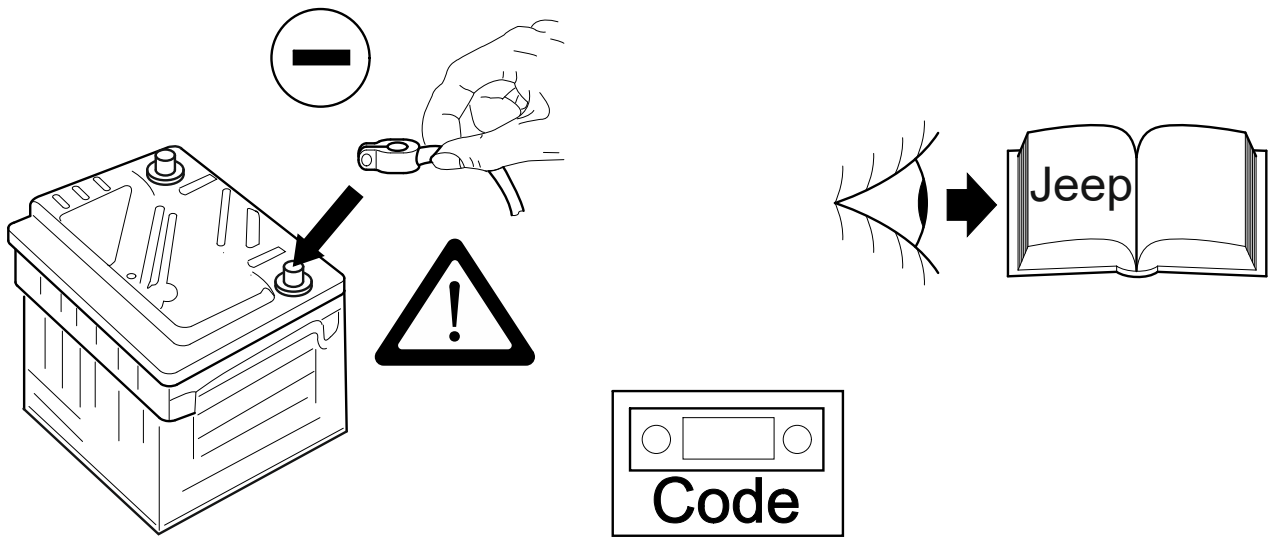

33

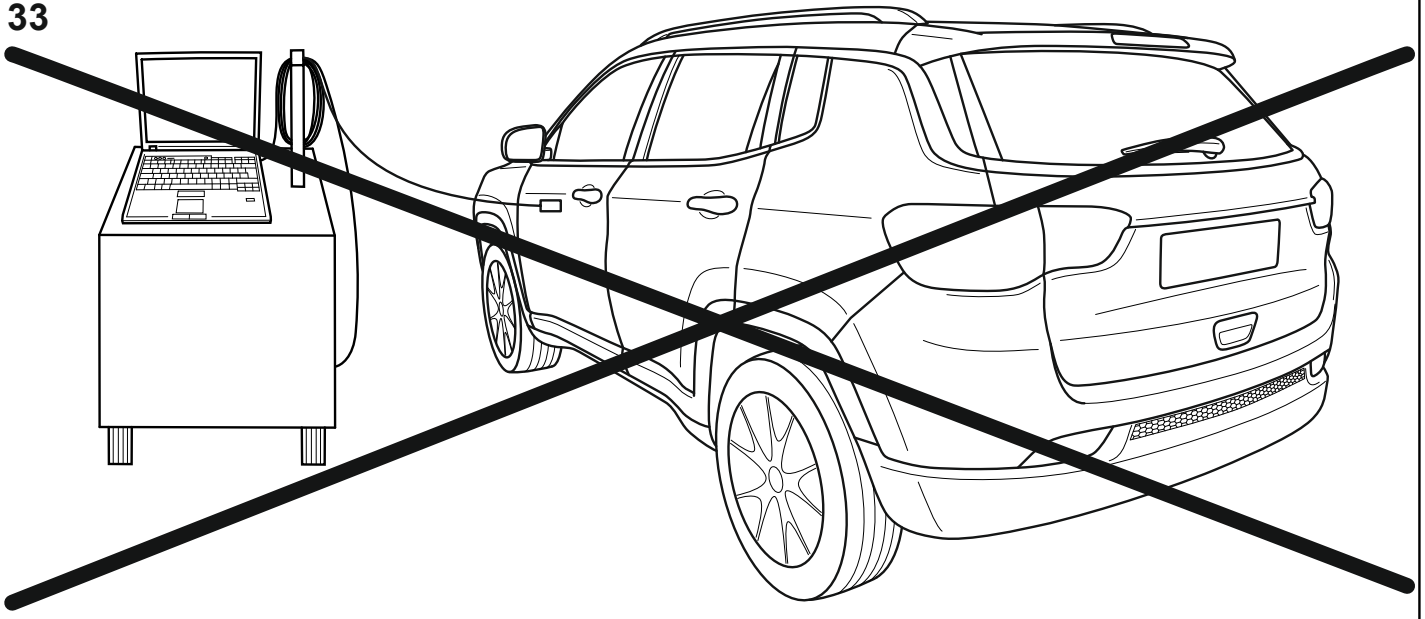

LED  ✓

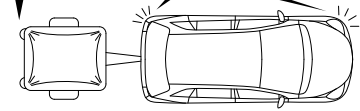
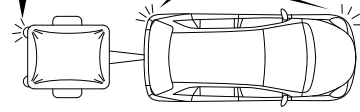
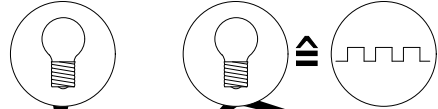
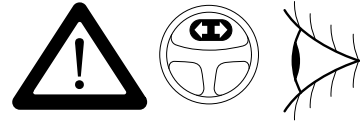
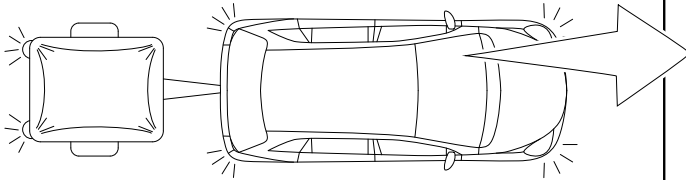

Trailer simulation for carcheck 7-pin and 13-pin  
WA no.: 900 001 300 198

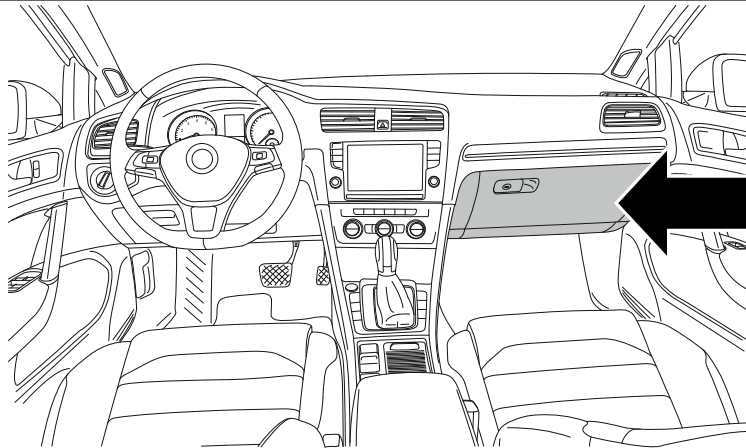
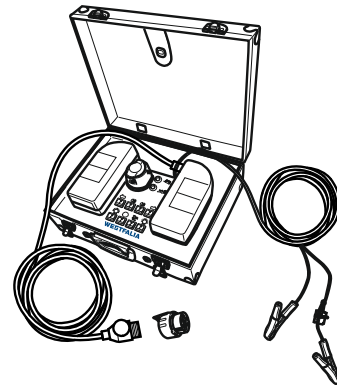

+



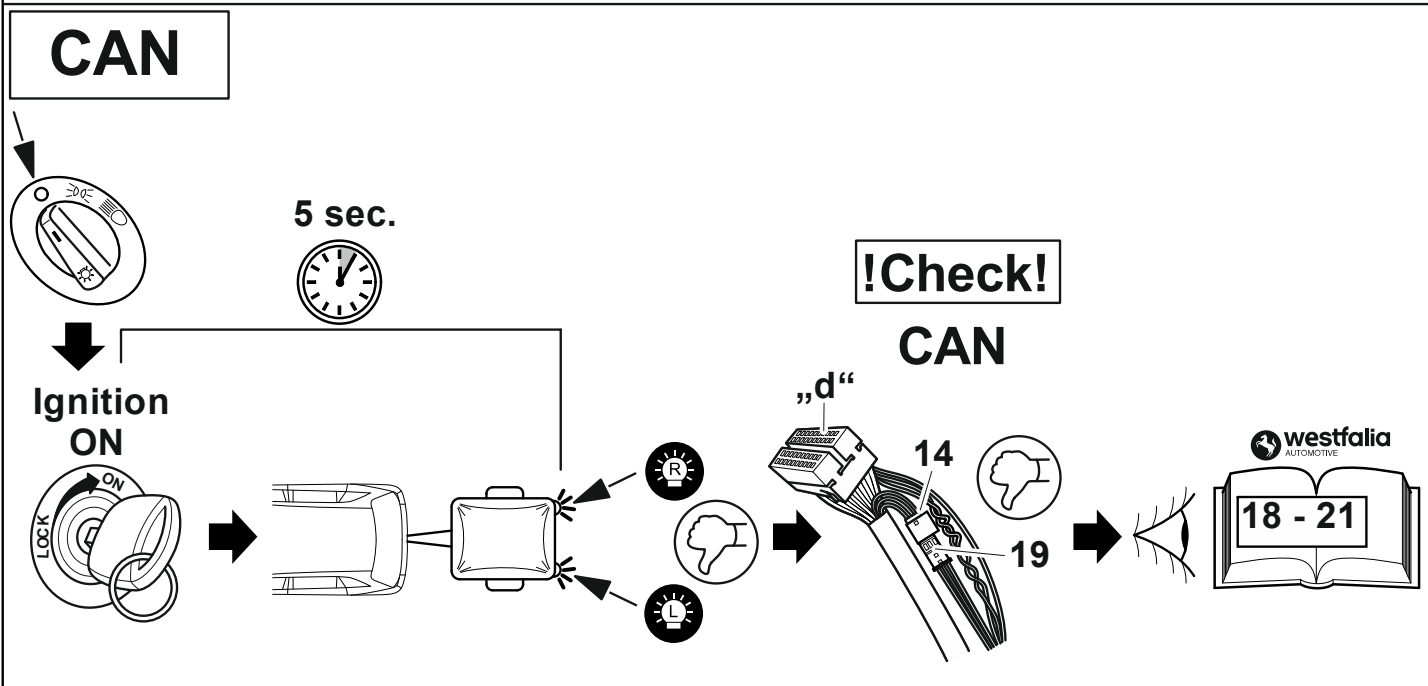
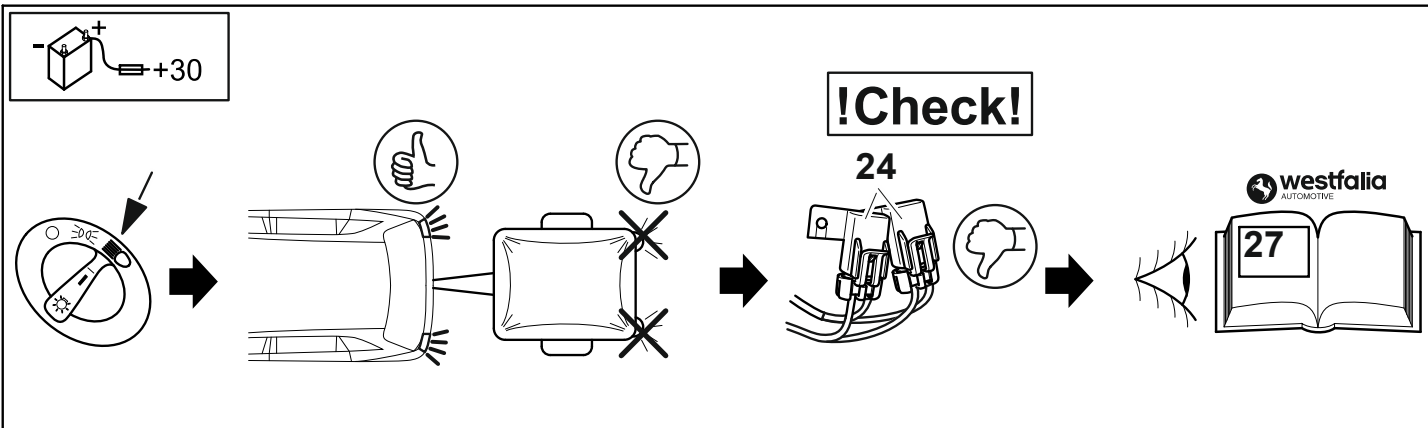

pin 10

pin 11

**westfalia**  
AUTOMOTIVE

WA no.: 300 028 300 113

**Optional:  
Adapter socket**

**westfalia**  
AUTOMOTIVE

13-pin

7-pin

WA no.: 300 100 320 113

WA no.  
900 001 506 124

WA no.  
900 001 507 189

**westfalia**  
AUTOMOTIVE

**Westfalia Cycle Carrier**  
WA no.: 350 050 600 001

**Box**  
WA no.: 350 002 600 001