

- D** Elektroanlage für Anhängervorrichtung Montage- und Betriebsanleitung, Originalbetriebsanleitung
- CZ** Elektrické zařízení pro tažné zařízení Návod k montáži a použití
- DK** Elsæt til anhængertræk Monterings- og betjeningsvejledning
- E** Instalación eléctrica para el dispositivo de remolque Instrucciones de montaje y uso
- F** Installation électrique pour dispositif d'attelage Notice de montage et d'utilisation
- FIN** Vetolaitteen sähköjärjestelmä Asennus- ja käyttöohje
- GB** Electrical system for trailer hitch installation and operating manual
- GR** Ηλεκτρικό σύστημα για διάταξη ρυμούλκησης Οδηγίες τοποθέτησης και λειτουργίας
- HU** Elektromos felszerelés a vonószerkezet Szerelési- és üzemeltetési utasítások
- I** Impianto elettrico per gancio di traino Istruzioni di montaggio e per l'uso
- N** Elektrisk anlegg for tilhengerfeste Monterings- og bruksanvisning
- NL** Elektrische installaties voor aanhanger Montage- en gebruikshandleiding
- PL** Instalacja elektryczna do haka holowniczego Instrukcja montażu i obsługi
- RUS** Электрооборудование сцепки Инструкция по монтажу и эксплуатации
- S** Elsystem för dragkrok Monterings- och bruksanvisning

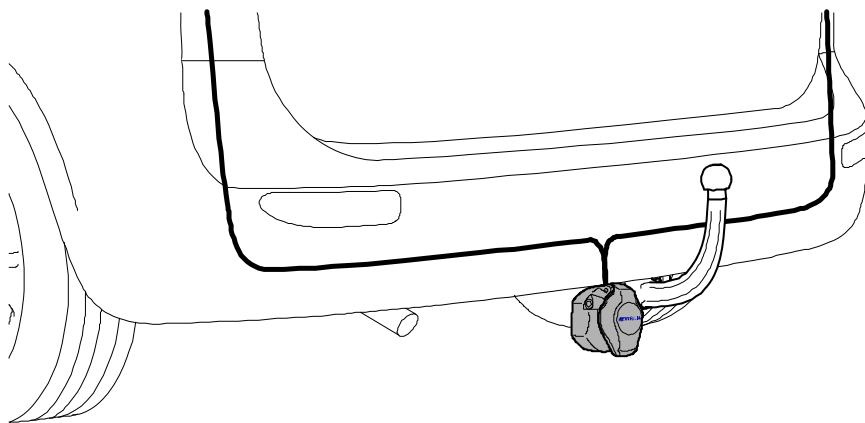

**335 251 300 107**

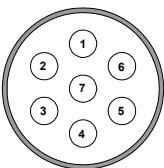

**335 251 300 113**

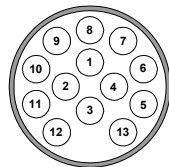

**Toyota RAV4, 03/2006→**

<b>D</b>	Steckdosenbelegung	<b>CZ</b>	Obsazení zásuvky	<b>DK</b>	Koblingskema
<b>E</b>	Esquema de tomas de enchufe	<b>F</b>	Affectation des prises électriques	<b>FIN</b>	Pistorasian navat
<b>GB</b>	Pin assignment	<b>GR</b>	Αντιστοιχία πριζας	<b>HU</b>	Csatlakozódugó leosztása
<b>I</b>	Schema dei collegamenti della presa	<b>N</b>	Kontaktksjema	<b>NL</b>	Contactdoosbezetting
<b>PL</b>	Rozkład pinów	<b>RUS</b>	Разводка розеток	<b>S</b>	Stickdosschema

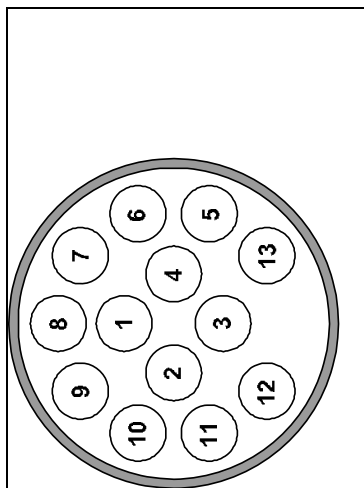

ISO 11446

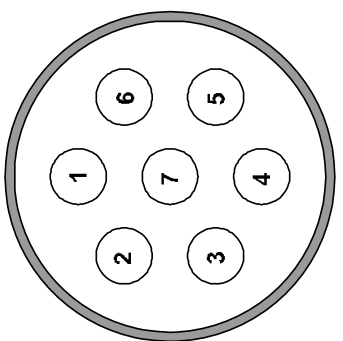

12N ISO1742

	Leistung / Power	<b>D</b>	<b>CZ</b>	<b>DK</b>	<b>E</b>	<b>F</b>	<b>FIN</b>	<b>GB</b>	<b>GR</b>	<b>HU</b>	<b>I</b>	<b>N</b>	<b>NL</b>	<b>PL</b>	<b>RUS</b>	<b>S</b>
1 (L)	21 W	schwarz/weiß	černobílá	sort/hvid	negro/blanco	noir/blanc	musta/valkoinen	black/white	μαύρο/λευκό	fekete/fehér	nero/bianco	svart/hvit	zwart/wit	czarno/biały	черный/белый	svart/vit
2 (54g)	Min. 21 W Max. 42 W	weiß	bílá	hvid	bianco	blanc	valkoinen	white	λευκό	fehér	bianco	hvit	wit	biały	белый	vit
3 (31)		braun	hnědá	brun	marrón	marron	ruskea	brown	καφέ	barna	marrone	brun	bruin	brązowo	коричне вый	Brun
4 (R)	21 W	schwarz/grün	černo zelená	sort/grøn	negro/verde	noir/vert	musta/vihreä	black/green	μαύρο/πράσινο	fekete/zöld	nero/verde	svart/grønn	zwart/groen	czarno/zielony	черный/зеленый	svart/grøn
5 (58R)		grau/rot	šedo červená	grå/rød	gris/rojo	gris/rouge	harmaa/punainen	gray/red	γκρι/κόκκινο	szürke/piros	grigio/rosso	grå/rød	grijs/rood	szaro/czerwony	серый/красный	grå/rood
6 (54)		schwarz/rot	černo červená	sort/rød	negro/rojo	noir/rouge	musta/punainen	black/red	μαύρο/κόκκινο	fekete/piros	nero/rosso	svart/rød	zwart/rood	czarno/czerwony	черный/красный	svart/rød
7 (58L)		grau/schwarz	šedo černá	grå/sort	gris/negro	gris/noir	harmaa/musta	gray/black	γκρι/μαύρο	szürke/kete	grigio/nero	grå/svart	grijs/zwart	szaro/czarny	серый/черный	grå/svart
8		grün	zelená	grøn	verde	vert	vihreä	Green	πράσινο	zöld	verde	grønn	groen	zielony	зеленый	grøn
9 (+30)		rot	červená	rød	rojo	rouge	punainen	red	κόκκινο	piros	rosso	rød	rood	czerwony	красный	rød
10 (+15)		gelb	žlutá	gul	amarillo	jaune	keltainen	yellow	κίτρινο	sárga	giallo	gul	geel	żółty	желтый	gul
11 (31)		braun/weiß	hnědobílá	brun/hvid	marrón/blanco	marron/blanc	ruskea/valkoinen	brown/white	καφέ/λευκό	barna/fehér	marrone/bianco	brun/hvit	bruin/wit	brązowo/biały	коричне вый/белый	brun/vit
12																
13 (31)		braun	hnědá	brun	marrón	marron	ruskea	brown	καφέ	barna	marrone	brun	bruin	brązowo	коричне вый	brun

	<b>bk</b>	<b>wh</b>	<b>bn</b>	<b>gn</b>	<b>gy</b>	<b>rd</b>	<b>ye</b>	<b>bu</b>	<b>or</b>	<b>pu</b>
<b>D</b>	schwarz	weiß	braun	grün	grau	rot	gelb	blau	orange	violett
<b>CZ</b>	černo	bílá	hnědá	zelená	šedo	červená	žlutá	modrý	oranžový	fialový
<b>DK</b>	sort	hvid	brun	grøn	grå	rød	gul	blå	orange	violet
<b>E</b>	negro	blanco	marrón	verde	gris	rojo	amarillo	azul	anaranja-do	violeta
<b>F</b>	noir	blanc	marron	vert	gris	rouge	jaune	bleu	orange	violet
<b>FIN</b>	musta	valkoinen	ruskea	vihreä	harmaa	punainen	keltainen	sininen	oranssi	violetti
<b>GB</b>	black	white	brown	green	grey	red	yellow	blue	orange	purple
<b>GR</b>	μαύρο	λευκό	καφέ	πράσινο	γκρι	κόκκινο	κίτρινο	μπλε	πορτοκαλί	Μωβ
<b>HU</b>	fekete	fehér	barna	zöld	szürke	piros	sárga	kék	narancssárga	ibolyakék
<b>I</b>	nero	bianco	marrone	verde	grigio	rosso	giallo	blu	arancione	viola
<b>N</b>	svart	hvit	brun	grønn	grå	rød	gul	blå	oransje	folett
<b>NL</b>	zwart	wit	bruin	groen	grijs	rood	geel	blauw	oranje	violet
<b>PL</b>	czarno	biały	brązowo	zielony	szaro	czerwony	żółty	niebieski	pomarańczowe	fioletowe
<b>RUS</b>	черный	белый	коричневый	зеленый	серый	красный	желтый	голубой	оранжевый	пурпурный
<b>S</b>	svart	vit	brun	grön	grå	röd	gul	blå	orange	violett

**D**

Nationale Richtlinien über die Anbauabnahmen sind zu beachten.

Jegliche Änderungen bzw. Umbauten an der Elektroanlage sind verboten. Sie führen zum Erlöschen der Betriebserlaubnis. Vor Arbeitsbeginn die Einbauanleitung lesen.

Die Elektroanlage für Anhänger Vorrichtung darf nur von Fachunternehmen montiert werden. Bei falscher Montage besteht schwere Unfallgefahr!

Achtung – vor Arbeitsbeginn den Fehlerspeicher auslesen, ggf. Ruhestrom-Erhaltungsgerät verwenden, ansonsten können elektronisch gespeicherten Daten verloren gehen. Batterie abklemmen, um Beschädigungen der KFZ- Elektronik zu vermeiden. Leitungen dürfen weder eingeklemmt noch beschädigt sein. Alle Dichtungselemente ordnungsgemäß anbringen.

Bei Anhängerbetrieb wird die Nebelschlussleuchte des Zugfahrzeugs abgeschaltet.

Ein Steckdosenadapter darf nur im Anhängerbetrieb genutzt werden.

- Der Ausfall der Anhängerblinkleuchten wird durch die Erhöhung der Blinkfrequenz im Cockpit angezeigt.

**Die Prüfung der Anhängerfunktionen mit einem Anhänger oder einem Prüfgerät mit Belastungswiderständen durchführen.**

Der deutsche Text dieser Anleitung ist bindend.

Änderungen vorbehalten.

**CZ**

Je nutné dodržovat místní směrnice o demontáži nástaveb.

Veškeré změny příp. přestavby elektrického zařízení jsou zakázány. Mají za následek zánik platnosti povolení k provozu.

Před zahájením práce si prostudujte návod k montáži.

Elektrické zařízení pro tažné zařízení smí montovat pouze odborné podniky. Při chybné montáži hrozí vážné nebezpečí nehody!

Pozor – před zahájením práce načtěte paměť chyb, popř. použijte zařízení pro udržení klidového proudu, jinak můžete ztratit elektronicky uložená data. Odpojte akumulátorovou baterii, aby nedošlo k poškození elektronické soustavy vozidla.

Vodiče nesmí být sevřené ani poškozené. Všechny těsnicí prvky náležitě namontujte.

Při provozu s tažným zařízením se vypne koncové světlo do mlhy na tažném vozidle.

Adaptér zásuvky se smí používat jen při provozu s přívěsem.

- Výpadek směrových světel přívěsu je indikován ve vozidle zvýšenou frekvencí blikání.

**Kontrolu funkcí přívěsu provádějte pomocí přívěsu nebo vhodného kontrolního přístroje se zatěžovacími odpory.**

Německý text tohoto návodu je závazný.

Změny vyhrazeny.

**DK**

De nationale direktiver for montering af tilbehør skal overholdes.

Enhver ændring eller ombygning på el-anlægget er forbudt. Dette medfører, at typegodkendelsen ikke er gældende.

Læs monteringsvejledningen inden påbegyndelse af arbejdet.

Elsættet til anhængertrækket må kun monteres af kvalificeret personel. Ved forkert montering er der fare for alvorlige fejlfunktioner!

Bemærk – udlæs fejlloggen inden påbegyndelse af arbejdet, anvend evt. apparat til opretholdelse af hvilestrøm, ellers kan elektronisk lagrede data gå tabt. Frakobl batteriet for at undgå beskadigelse af personbilens elektronik.

Ledningerne må ikke hverken blive klemt eller beskadiget. Alle tætningsselementerne skal anbringes efter forskrifterne.

Ved brug af anhængerens elstik frakobles trækkøretøjets tågebaglygte.

En stikdåseadapter må udelukkende anvendes ved drift med anhængerens.

- Svigt af anhængerens blinklys vises via en forhøjet blinkfrekvens i instrumentpanelet.

**Kontrol af anhængerfunktionerne skal foretages med en anhænger eller et kontrolapparat med belastningsmodstand.**

Den tyske tekst i denne vejledning er bindende.

Ret til ændringer forbeholdes.

**E**

Deben respetarse las directivas nacionales referentes a controles de enganches.

Está prohibido modificar o remodelar la instalación eléctrica. La consecuencia sería la invalidación del permiso de circulación.

Antes de iniciar la tarea, lea las instrucciones de montaje.

La instalación eléctrica para el dispositivo de remolque sólo debe montarla personal cualificado. ¡En caso de montaje erróneo existe peligro de accidentes graves!

Atención – antes de iniciar la tarea, leer la memoria de fallos, si es necesario utilizar un dispositivo de mantenimiento de corriente de reposo, de lo contrario podría perder los datos memorizados electrónicamente. Desconecte la batería para evitar daños en la instalación eléctrica del vehículo.

Se debe evitar dañar o aprisionar los cables. Instalar correctamente todas las juntas.

Al circular con remolque se desconecta la luz antiniebla trasera del vehículo de tiro.

Sólo se puede usar un adaptador de caja de enchufe cuando se circule con remolque.

- Un error de los intermitentes del remolque se indicará aumentando la frecuencia de parpadeo en el cuadro de mando.

**La comprobación de las funciones del remolque debe efectuarse con un remolque o bien con un equipo de comprobación con resistores reguladores de carga.**

Es vinculante el texto alemán de estas instrucciones.

Nos reservamos el derecho a efectuar modificaciones.

**F**

Les dispositions nationales concernant la réception à titre isolé doivent être respectées.

Toute modification ou transformation de l'installation électrique est interdite. Elle entraînerait l'annulation de la réception.

Lire impérativement la notice de montage avant de commencer le travail.

Seules des entreprises spécialisées sont autorisées à monter le faisceau électrique du dispositif d'attelage. Un montage incorrect représente un risque élevé d'accident !

Attention – Avant de commencer le travail, éliminer l'ensemble des défauts présents dans la mémoire de l'ordinateur de bord ou utiliser un générateur de courant de veille pour éviter que des données enregistrées sur support électroniques ne soient perdues. Débrancher la batterie afin d'éviter tout endommagement de l'installation électronique du véhicule.

Les fils électriques ne doivent être ni endommagés ni coincés. Mettre en place tous les éléments d'étanchéité conformément à la notice.

Lorsqu'une remorque/caravane est attelée, le fonctionnement du feu de brouillard arrière du véhicule tracteur est interrompu.

Un adaptateur pour prise de courant ne doit être utilisé que si une remorque/caravane est tractée.

- Une panne des clignotants de la remorque/caravane est signalée par l'augmentation de la fréquence de clignotement dans l'habitacle.

**Le contrôle des fonctions de l'attelage doit s'effectuer avec une remorque ou avec un appareil de contrôle muni d'ampoules classiques.**

Le texte allemand de cette notice fait foi.  
réserve de modifications.

Sous

**FIN**

Kansallisia suuntaviivoja, mitä tulee asennukseen, on noudatettava.

Kaikki sähköjärjestelmään tehtävät muutokset tai jälkiasennukset ovat kiellettyjä. Nämä johtavat käyttöluvan raukeamiseen.

Lue asennusohjeet ennen työskentelyn aloittamista.

Vetolaitteen sähköjärjestelmän saa asentaa vain alan erikoisliike. Virheellinen asennus voi aiheuttaa vakavan onnettomuuden!

Huomio: lue vikamuisti ennen työskentelyn aloittamista. Käytä tarvittaessa lepovirran säilymisen varmistavaa laitetta, jotta elektronisesti tallentuneet tiedot eivät katoa muistista. Irrota akun navat, jotta ajoneuvon elektroniikka ei vaurioidu.

Johdot eivät saa jäädä puristuksiin eivätkä vaurioitua. Kiinnitä kaikki tiiviste-elementit asianmukaisesti.

Vetoajoneuvon takasummuvalot eivät toimi vetolaitteen käytön aikana.

Pistorasia-adaptoria saa käyttää ainoastaan perävaunun yhteydessä.

- Perävaunun suuntavilkkujen toimintahäiriön ilmaisee merkkivalon vilkkumistaajuuden kasvu ohjaamossa.

**Perävaunuun liittyvät toiminnot on testattava joko perävaunun kanssa tai kuormitusvastuksilla varustetulla testauslaitteella.**

Tämän ohjeen saksankielinen teksti on sitova.

Oikeudet muutoksiin pidätetään.

**GB**

Observe national guidelines on the approval of accessories.

Any alteration or modification of the electrical system is prohibited and voids the operating licence.

Read the installation manual before beginning to work.

Only qualified companies may install the electrical system for the trailer hitch. Improper assembly may result in a serious accident hazard!

Attention – before starting to work, read out the errors stored in the memory. If required, use a power supply to prevent electronically saved data from being erased. Disconnect the battery to prevent damage to the vehicle electronics.

Verify that no cables are squeezed or damaged. Properly install all seals.

When towing a trailer, the rear fog light of the pulling vehicle is switched off.

An electrical socket adapter may only be used when towing a trailer.

- A failure of the trailer turn signal lamps is indicated by an increased flashing rate of the pilot lamp in the cockpit.

**Check the trailer functions with a trailer or a testing instrument with load resistors.**

The German text of this instruction is binding.

Subject to change.

**GR**

Πρέπει να τηρούνται οι κρατικοί κανονισμοί σχετικά με τον έλεγχο προσθηκών στα αμαξώματα.

Απαγορεύονται οι αλλαγές και οι μετατροπές στην ηλεκτρική εγκατάσταση. Συνυπάγονται την ακύρωση της άδειας λειτουργίας.

Πριν από την έναρξη των εργασιών μελετήστε τις οδηγίες τοποθέτησης.

Το ηλεκτρικό σύστημα για διατάξεις ρυμούλκησης επιτρέπεται να τοποθετείται μόνο από ειδικά συνεργεία. Σε περίπτωση λάθους τοποθέτησης υπάρχει κίνδυνος σοβαρών ατυχημάτων!

Προσοχή – Πριν από την έναρξη των εργασιών διαβάστε τη μνήμη σφαλμάτων ή αντίστοιχα χρησιμοποιήστε μία συσκευή διατήρησης ρεύματος. Διαφορετικά μπορεί να χαθούν τα ηλεκτρικά αποθηκευμένα δεδομένα. Αποσυνδέστε την μπαταρία ώστε να αποφευχθούν οι ζημιές στα ηλεκτρονικά του οχήματος.

Τα καλώδια δεν πρέπει ούτε να μαγκώνονται ούτε να είναι χαλασμένα. Τοποθετήστε σωστά όλα τα στοιχεία στεγανοποίησης.

Κατά την οδήγηση με τρέιλερ το πίσω φανάρι ομίχλης του έλκοντος οχήματος απενεργοποιείται.

Ένας προσαρμογέας πρίζας επιτρέπεται να χρησιμοποιηθεί μόνο κατά την οδήγηση με τρέιλερ.

- Η τυχόν βλάβη των φώτων της διάταξης ρυμούλκησης εμφανίζεται στο ταμπλό με αύξηση της συχνότητας αναβοσβήσματος.

**Ο έλεγχος των λειτουργιών της ρυμούλκας πρέπει να γίνεται ή με μία ρυμούλκα ή με μια συσκευή μετρήσεων με αντιστάσεις καταπόνησης.**

Το γερμανικό κείμενο αυτών των οδηγιών είναι δεσμευτικό.

Διατηρούμε το δικαίωμα αλλαγών.

**HU**

Figyelembe kell venni a műszaki átvételre vonatkozó nemzeti irányelveket.

Az elektromos felszerelésen tilos bármiféle átalakítást végezni. A szerkezet megváltoztatása vagy átalakítása a forgalmi engedély megszűnését vonja maga után.

A munka megkezdése előtt olvassa el a szerelési útmutatót.

A vonószerkezet elektromos részét csak szaküzem szerelheti be. Helytelen szerelés súlyos balesethez vezethet!

Figyelem – a munka megkezdése előtt olvassa ki a hibatárolót, adott esetben használjon nyugalmi áramot fenntartó készüléket, máskülönben elveszhetnek az elektronikusan tárolt adatok. Kösse le az akkumulátort, hogy megelőzze a gépjármű elektronikájának megrongálódását.

A vezetékek nem lehetnek becsípődve vagy megrongálódva. Minden szigetelő elemet a rendeltetésének megfelelően szereljen.

Utánfutóüzemben ki lesz kapcsolva a vontatójármű hátsó ködlámpája.

Dugóaljzat adaptert csak vontatóüzemben szabad használni.

- Az utánfutó indexlámpáinak kiesését a műszerfalán a villogás gyorsulása jelzi.

**Ellenőrizze az utánfutó funkciók működését egy utánfutóval vagy egy terhelő ellenállásokkal ellátott ellenőrzőkészülékkel.**

A német szerelési utasítás betartása kötelező.

Változtatások jogát fenntartjuk.

**I**

Devono essere osservate le normative nazionali sui collaudi.

È vietato modificare o montare diversamente l'impianto elettrico. Ciò comporta l'annullamento del permesso di circolazione.

Prima di iniziare i lavori, leggere le istruzioni di montaggio.

L'impianto elettrico per il gancio di traino deve essere montato solo da personale specializzato. In caso di montaggio errato sussiste il pericolo di incidenti gravi!

Attenzione – prima di iniziare i lavori, leggere la memoria errori, se necessario utilizzare un dispositivo di mantenimento della corrente di riposo per non perdere i dati memorizzati. Scollegare la batteria al fine di evitare danni all'impianto elettronico del veicolo.

I cavi non devono essere schiacciati né danneggiati. Installare correttamente gli elementi di tenuta.

Durante il funzionamento con rimorchio la luce antinebbia posteriore della motrice viene spenta.

Utilizzare un adattatore per prese esclusivamente per il funzionamento con rimorchio.

- Un guasto agli indicatori di direzione del rimorchio viene segnalato da una frequenza di lampeggio più veloce sul quadro comandi.

**Il controllo delle funzioni del rimorchio deve essere eseguito con un rimorchio o con un apparecchio di controllo con resistenza di carico.**

È vincolante il testo tedesco di queste istruzioni.

Con riserva di modifiche.

**N**

Nasjonale retningslinjer om godkjennelse av monteringer skal overholdes.

Enhver endring hhv. ombygging av det elektriske anlegget er forbudt. Dette vil ødelegge brukeropplevelsen.

Les montasjeveiledningen før man begynner arbeidet.

Det elektriske anlegget til tilhengerfestet må kun monteres av fagbedrift. Det er stor fare for at det kan oppstå ulykker ved feil montering!

OBS – før arbeidet starter må man lese av feilminnet hhv. benytte hvilestrøms-måleapparat for å unngå at elektronisk lagrede data går tapt. Koble fra batteriet for å unngå at kjøretøyelektronikken skades.

Ledninger må verken klemmes fast eller skades. Alle tetningsselementer må monteres på plass i riktig posisjon.

Ved bruk av tilhenger blir baklysene til trekkvognen koblet ut.

Stikkontaktadapteret må kun brukes i kombinasjon med tilhenger.

- Hvis blinklysene på tilhengeren faller ut, indikeres dette i førerhuset ved at blinkfrekvensen øker.

**Kontrollen av tilhengerfunksjonen foretas med en tilhenger eller et kontrollinstrument med belastningsmotstander.**

Den tyske teksten i denne veiledningen er bindende.

Med forbehold om endringer.

**NL**

Nationale richtlijnen betreffende de montagegoedkeuring moeten in acht worden genomen.

Elke wijziging van de elektrische installatie is verboden. Wijziging leidt tot verval van de gebruikstoestemming.

Voor montage eerst de inbouwhandleiding lezen.

De elektrische installatie voor aanhanger mag alleen door vakkundig personeel worden gemonteerd. Bij verkeerde montage bestaat ernstig gevaar voor ongevallen!

Attentie – voor montage het foutgeheugen afezen, eventueel ruststroomapparaat gebruiken, anders kunnen elektrisch opgeslagen gegevens verloren gaan. Los de accu klemmen om beschadiging van de voertuigelektroniek te vermijden.

Leidingen mogen niet klemmen of beschadigd zijn. Alle afdichtelementen volgens voorschrift aanbrengen.

Bij gebruik van de aanhanger wordt het mistachterlicht van het voertuig uitgeschakeld.

Een contactdoosadapter mag uitsluitend bij het rijden met aanhangwagen worden gebruikt.

- Uitvallen van de aanhangerknipperlichten wordt door een verhoogde knipperfrequentie in de het instrumenten paneel aangegeven.

**De controle van de aanhangerfuncties met een aanhanger of een testapparaat met belastingsweerstand uitvoeren.**

De Duitse tekst van deze handleiding is bindend.

Wijzigingen voorbehouden.

**PL**

Proszę przestrzegać krajowych wytycznych dotyczących odbioru technicznego.

Wszelkie zmiany lub przebudowy instalacji elektrycznej są zabronione. Spowodują one utratę ważności świadectwa homologacji.

Przed rozpoczęciem pracy należy przeczytać instrukcję montażu.

Instalacja elektryczna do haka holowniczego może zostać zamontowana wyłącznie przez firmę specjalistyczną. W przypadku nieprawidłowego montażu istnieje poważne ryzyko wypadku!

Uwaga! Przed rozpoczęciem pracy należy sprawdzić pamięć błędów i w razie potrzeby zastosować urządzenie utrzymujące prąd ciągły. W przeciwnym razie może dojść do utraty danych elektronicznych. Odłączyć akumulator w celu uniknięcia uszkodzeń w instalacji elektrycznej pojazdu.

Przewody nie mogą być zaciśnięte ani uszkodzone. Prawidłowo zamontować wszystkie elementy uszczelniające.

Podczas holowania przyczepy odłączone jest tylne światło przeciwmgielne.

Adapter gniazda może być używany tylko podczas holowania przyczepy.

- Awaria kierunkowskazów przyczepy sygnalizowana jest na desce rozdzielczej przez szybciej migającą kontrolkę.

**Funkcje przyczepy należy sprawdzić z podłączoną przyczepą lub za pomocą przyrządu kontrolnego z opornością obciążenia.**

Tekst niniejszej instrukcji w języku niemieckim jest wiążący.

Zmiany zastrzeżone.

**RUS**

Подлежат соблюдение национальные директивы о порядке приемки навесного/встраиваемого оборудования.

Какие-либо изменения и переделки на электрооборудовании недопустимы. Они делают недействительным разрешение на эксплуатацию.

Перед началом работы прочесть инструкцию по монтажу.

К монтажу электрооборудованию сцепного устройства допускаются только специализированные фирмы. При неправильном монтаже грозит опасность тяжелых травм!

Внимание – перед началом работы прочесть содержимое накопителя сбоя, при необходимости воспользоваться источником бесперебойного питания во избежание потери сохраненных данных в электронных устройствах. Отсоединить батарею, чтобы предотвратить повреждение электроники автомобиля.

Не допускать заземления и повреждения электропроводки. Все уплотнения устанавливать как положено.

При использовании прицепа отключать на тягаче заднюю противотуманную фару.

Пользоваться розеточным переходником только при работе с прицепом.

- Отказ мигалок прицепа отображается в кабине учащенным миганием.

**Проверку работы прицепа вести с самим прицепом или пробником с нагрузочными сопротивлениями.**

Обязательным является немецкий текст данной инструкции.

Право на внесение изменений сохраняется.

**S**

Nationella riktlinjer beträffande monteringen skall beaktas.

All form av ändring respektive ombyggnad på elsystemet är förbjuden. Förändringar resulterar i att körtillståndet upphör att gälla.

Läs igenom monteringsanvisningarna innan arbetet påbörjas.

Elsystemet för dragkroken får endast monteras av kvalificerade tekniker. Vid felaktig montering föreligger risk för allvarliga olyckor!

Obs – innan arbetet påbörjas, läs av felminnet och använd vid behov enheten för bibehållning av vilostrom, annars kan elektroniskt sparade data gå förlorade. Frånkoppla batteriet för att undvika skador på fordonselektroniken.

Ledningarna får inte vara klämda eller skadade. Montera alla tätningselement korrekt.

När släpvagnen är påhängd släcks dragfordonets dimbakljus.

Stickdosadaptern får bara användas i kombination med släpvagn.

- Om blinkerljusen på släpvagnen är ur funktion, visas detta genom att lampan i instrumentpanel blinkar snabbare än normalt.

**Släpvningsfunktionerna ska kontrolleras med hjälp av en påhängd släpvagn eller en provningsutrustning med belastningsmotstånd.**

Den tyska texten i denna anvisning är bindande.

Ändringar förbehålls.

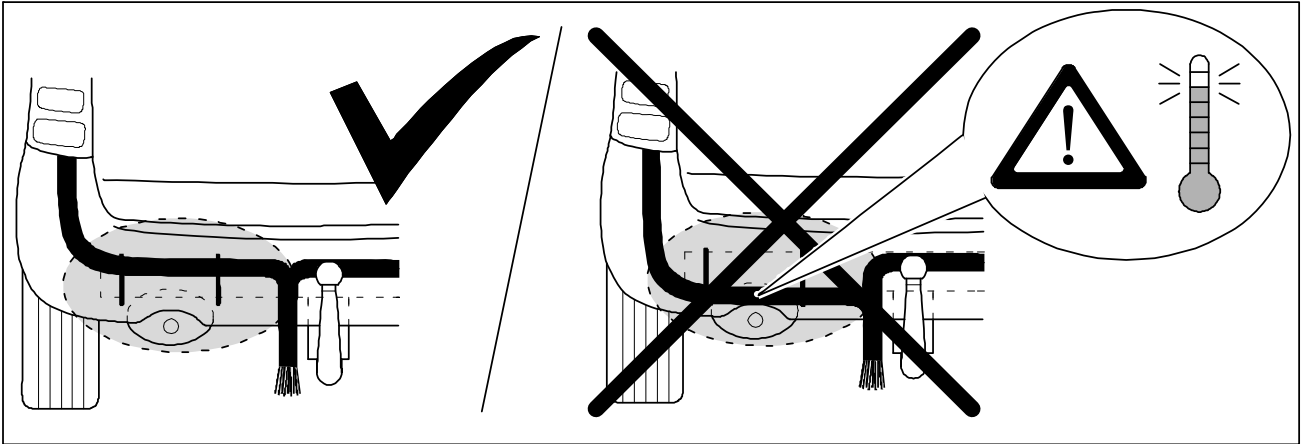
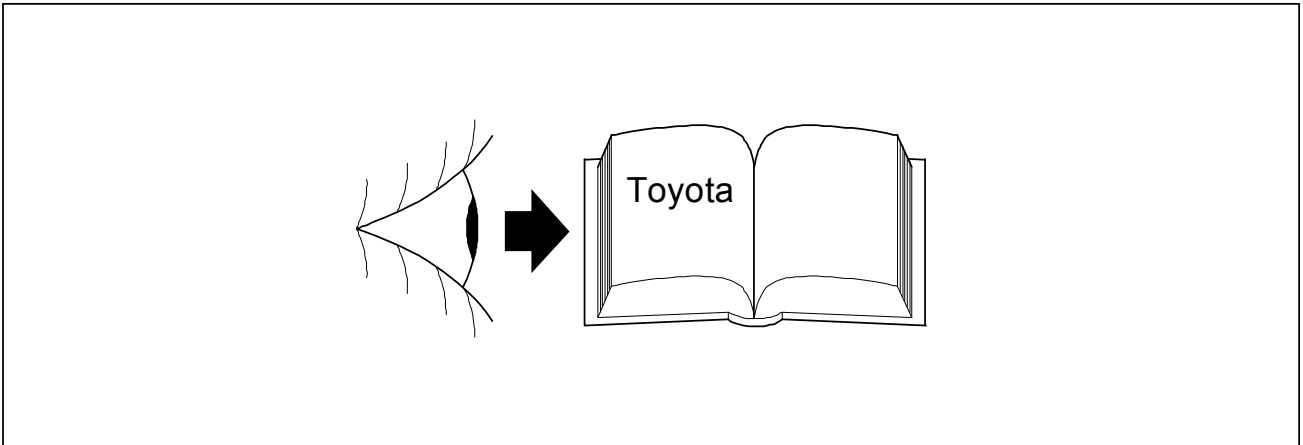





13 Pole

**A**

1x

335 251 300 183

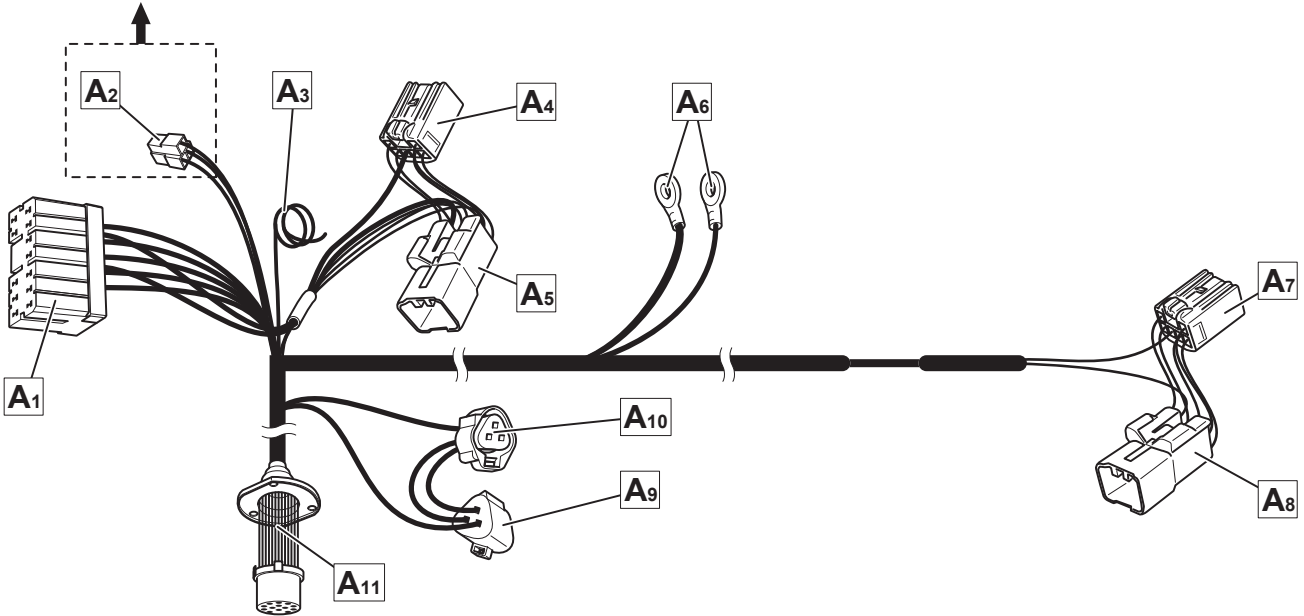

**C**

1x



WA: 900 001 506 123

**D**

1x

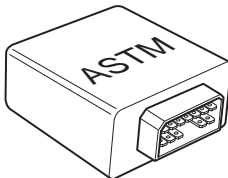

WA: 900 001 506 542

**E**

3x

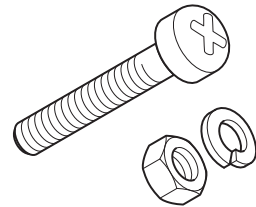

**F**

15x

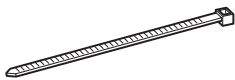

**G**

3x

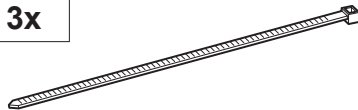

**H**

2x

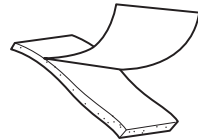

**I**

4x





7 Pole

**A**

1x

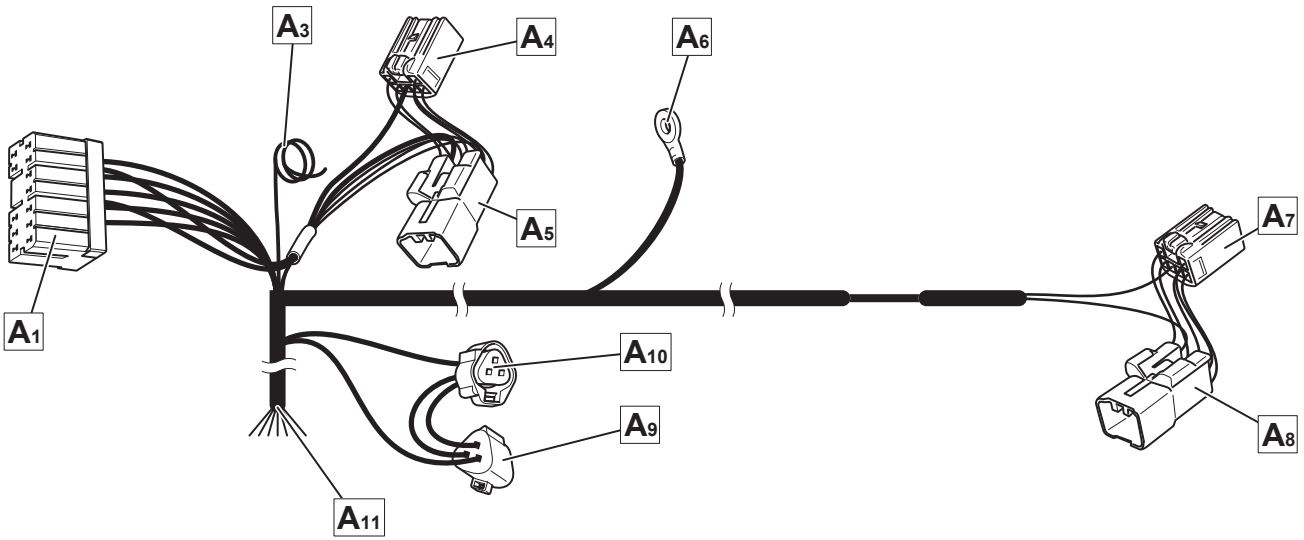

**B**

1x

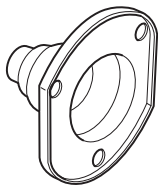

**C**

1x

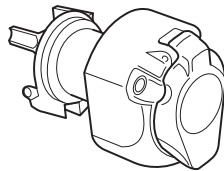

WA: 900 001 506 424

**D**

1x

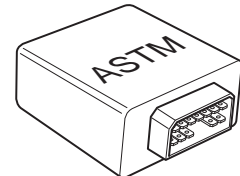

WA: 900 001 506 542

**E**

3x

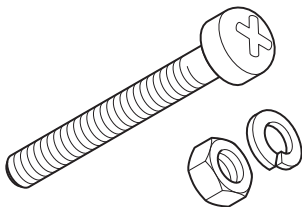

**F**

15x



**G**

3x

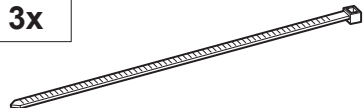

**H**

2x

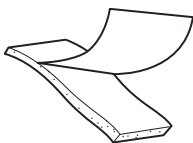

**I**

4x



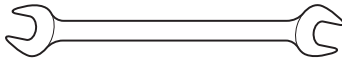

10 mm

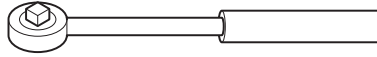
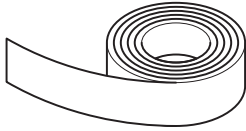
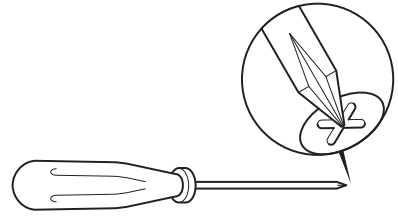
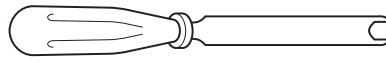

8/10/14 mm

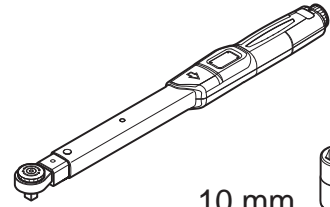

10 mm



## VERLEGESCHEMA

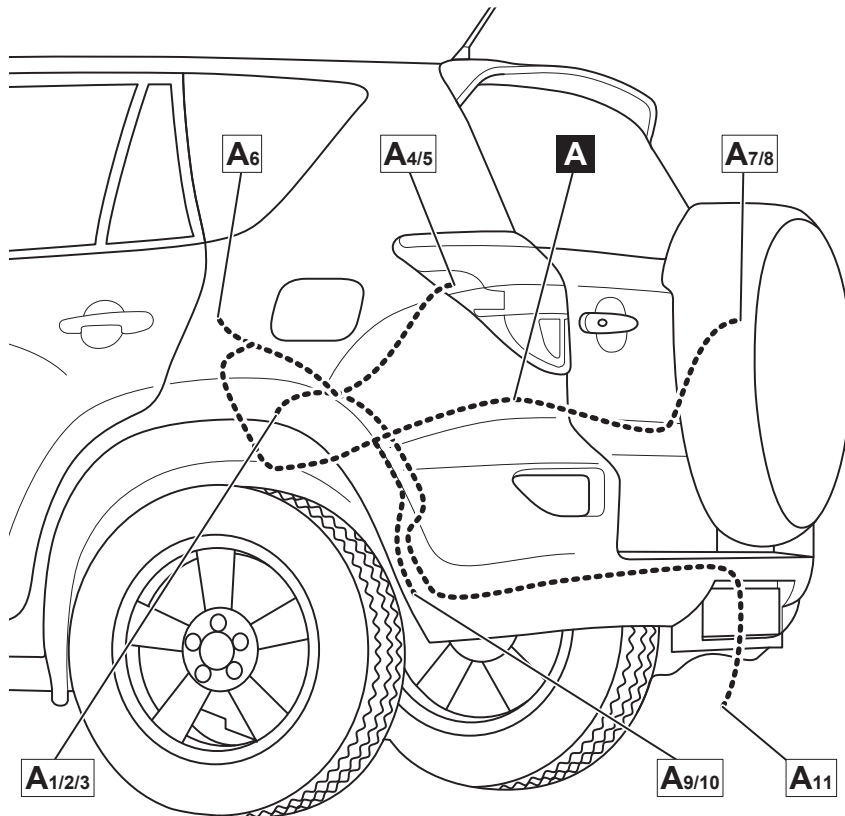

1



10 mm

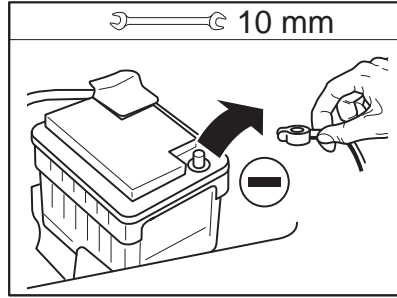
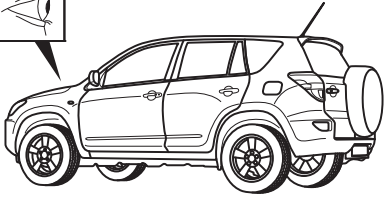
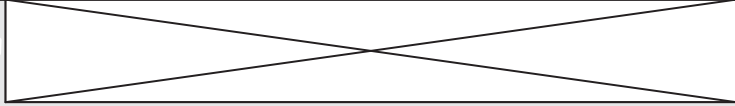

2

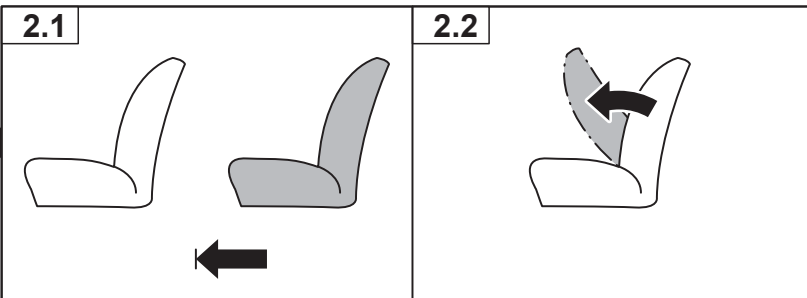
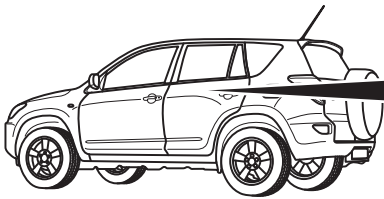
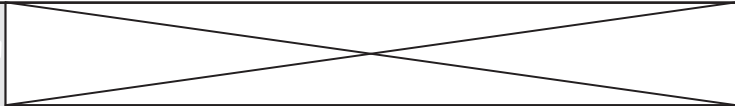
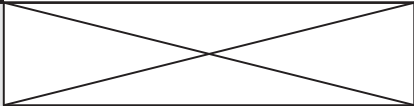

# 3

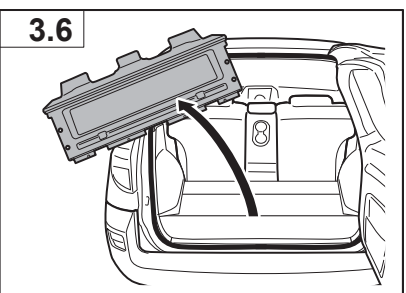
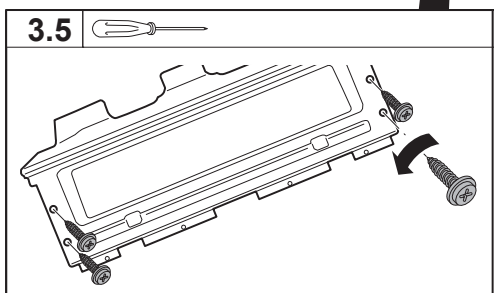
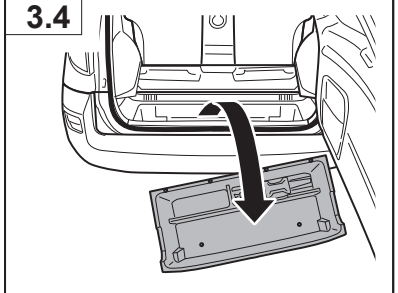
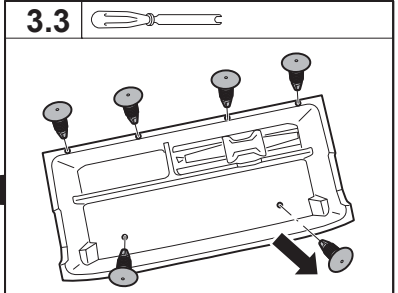
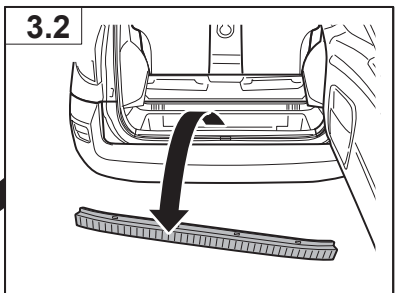
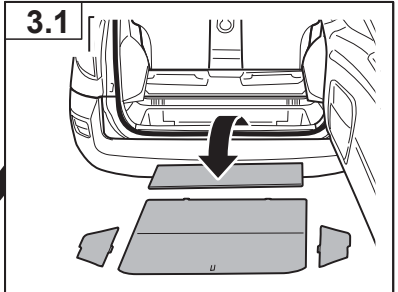
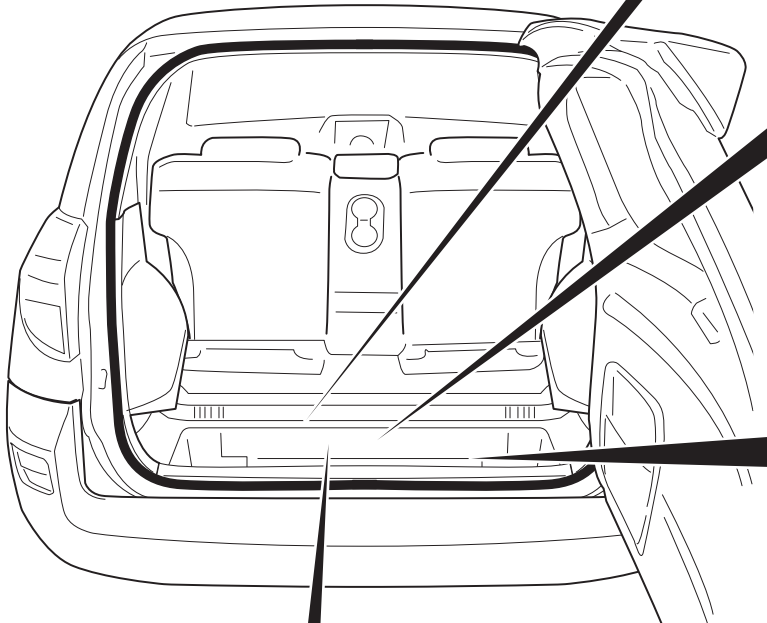
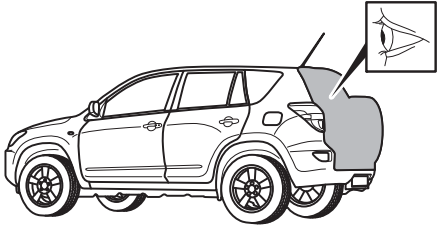
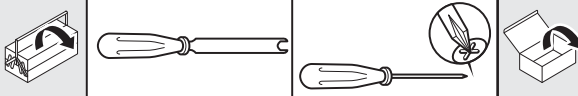

# 4

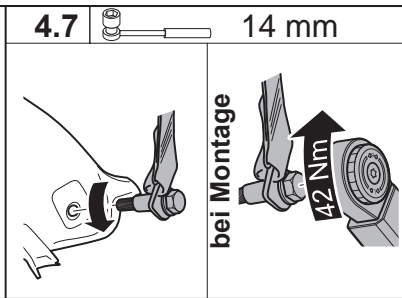
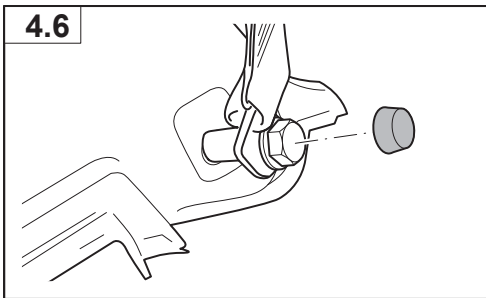
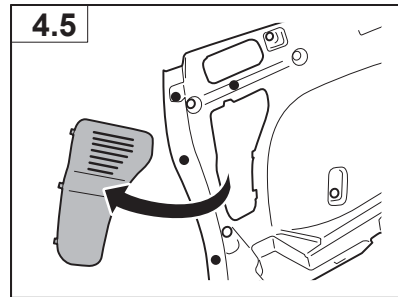
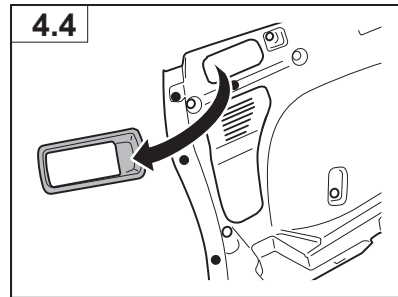
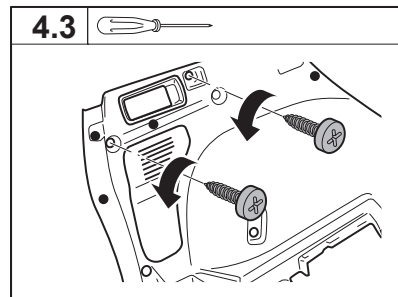
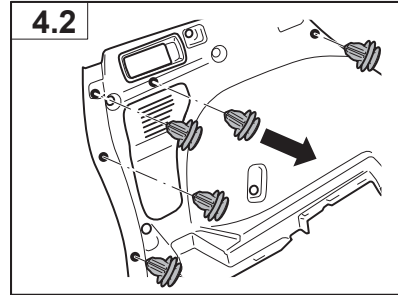
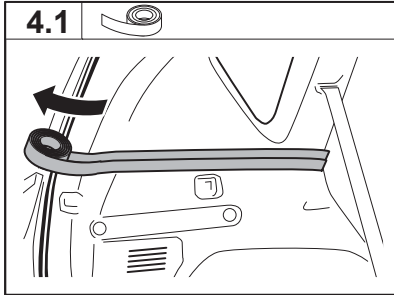
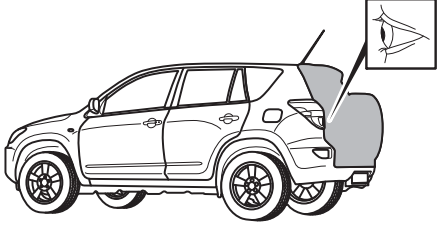
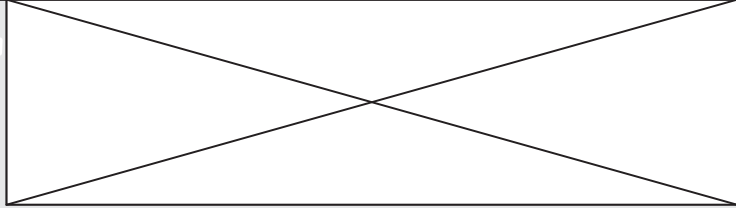
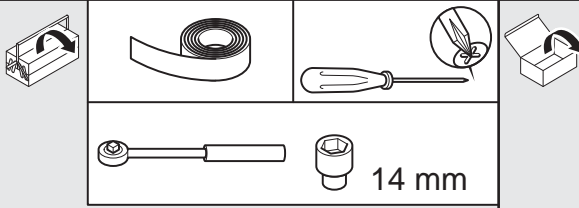

# 5

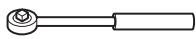

14 mm  
10 mm

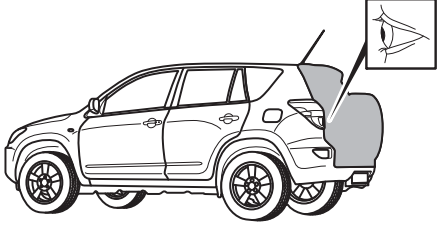
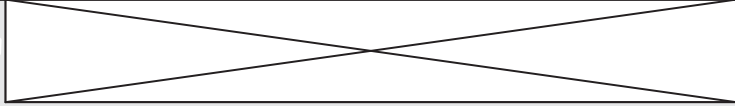

5.1

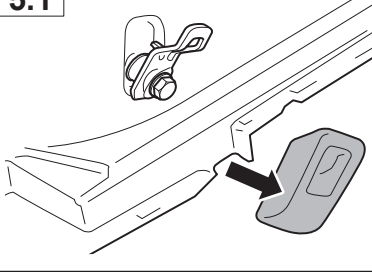

5.2

14 mm

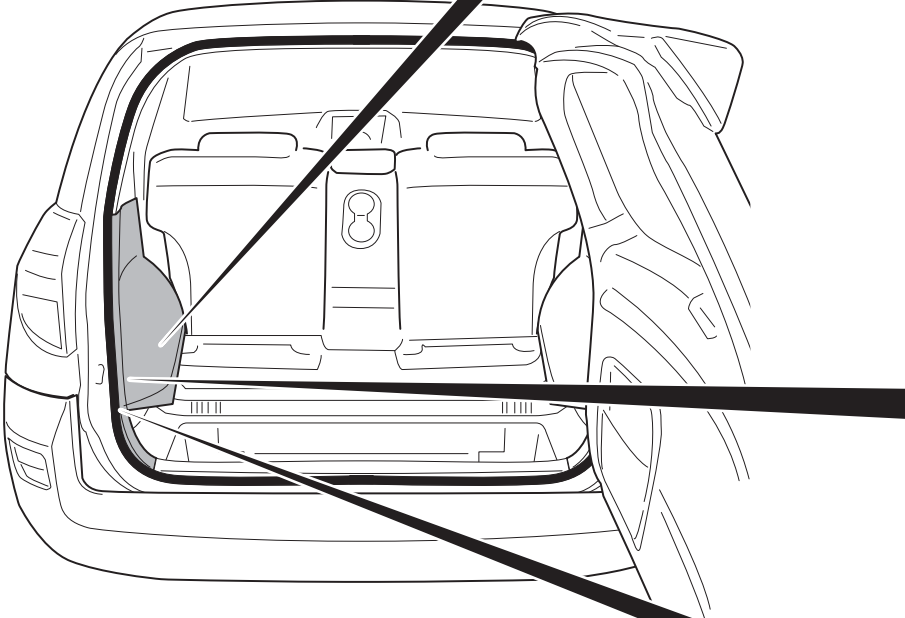
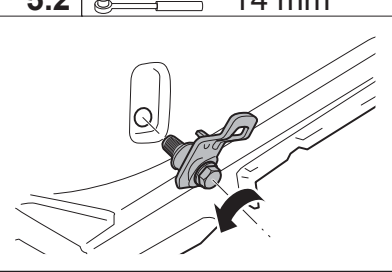

5.3

10 mm

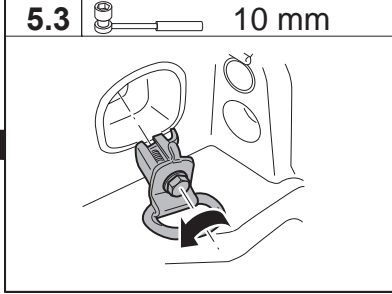

5.4

12V  
120W

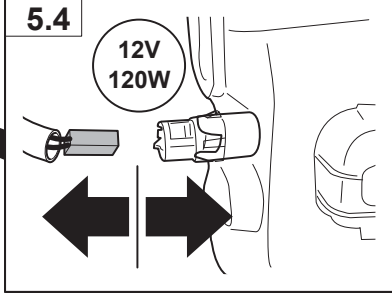

5.5

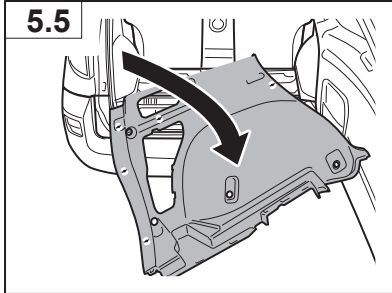

# 6

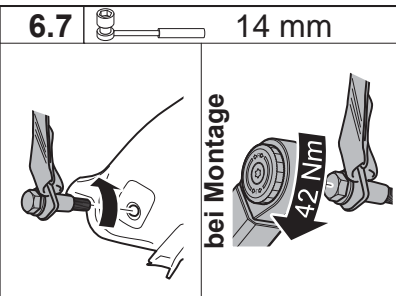
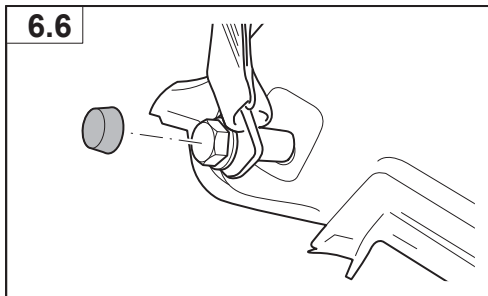
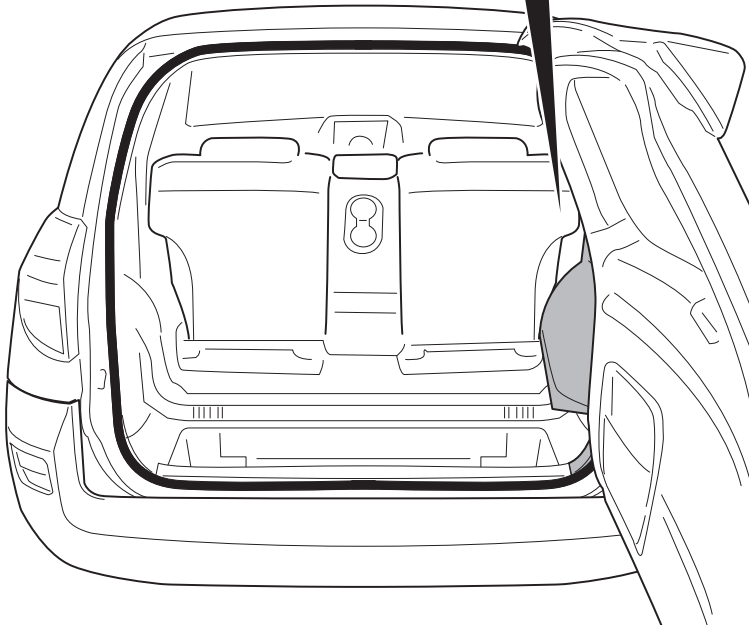
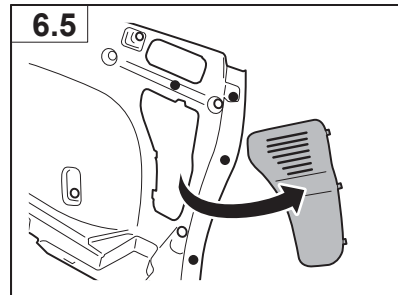
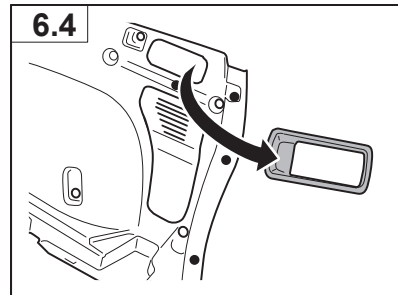
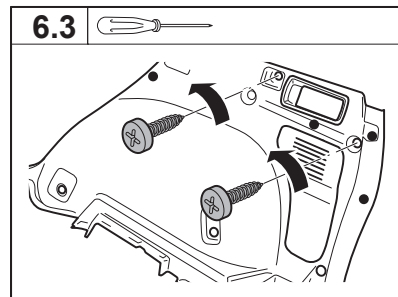
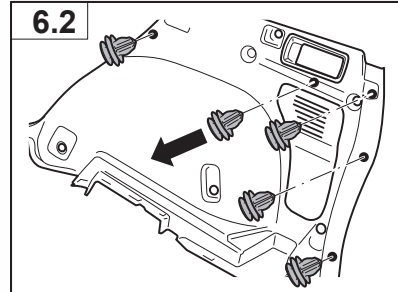
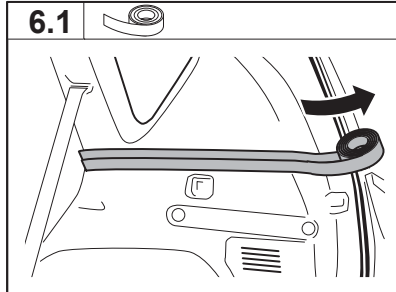
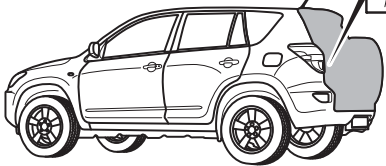
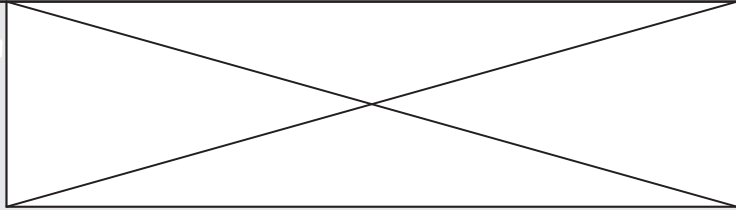
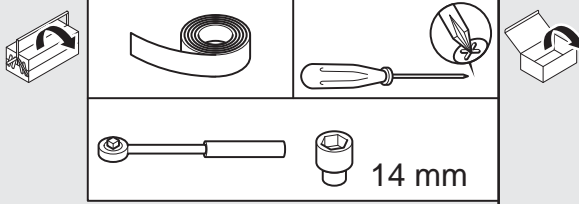



# 7

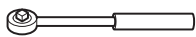

14 mm  
10 mm

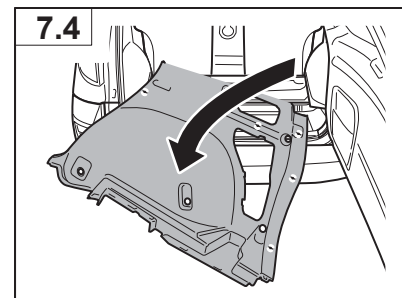
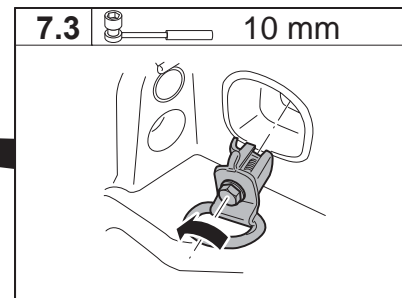
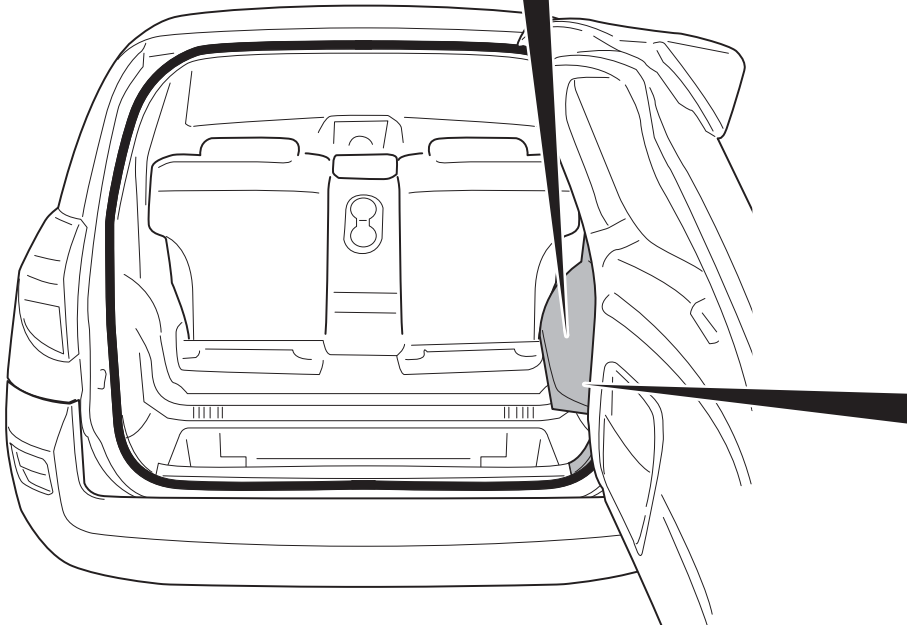
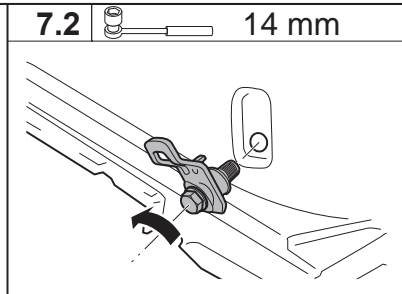
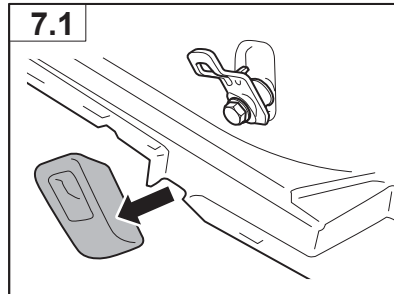
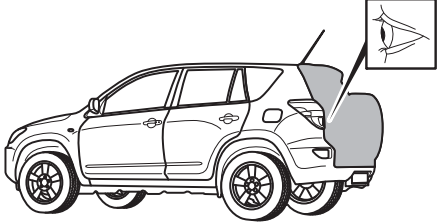
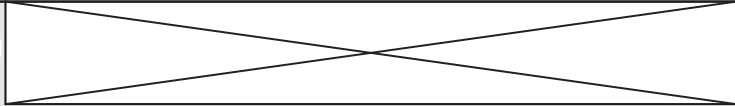

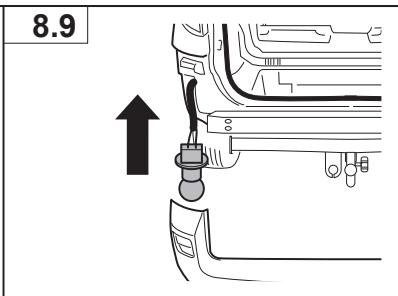
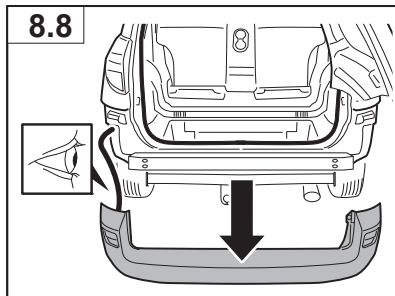
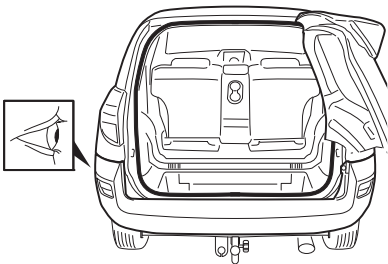
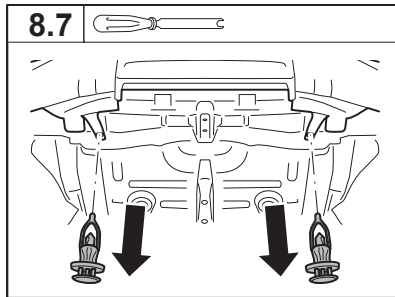
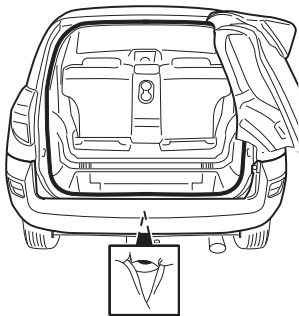
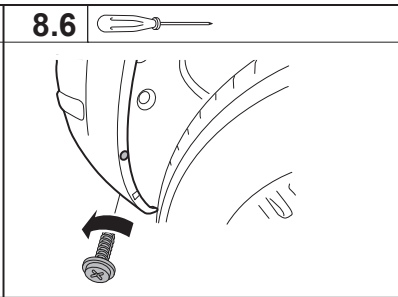
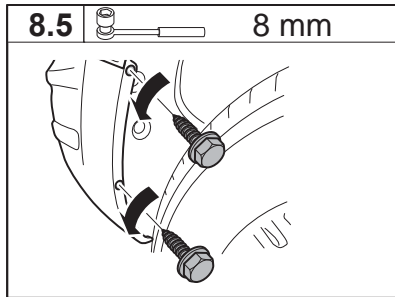
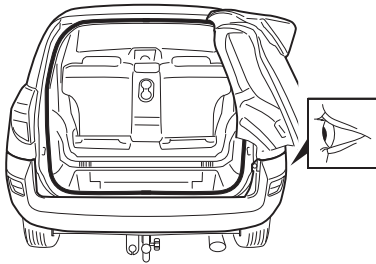
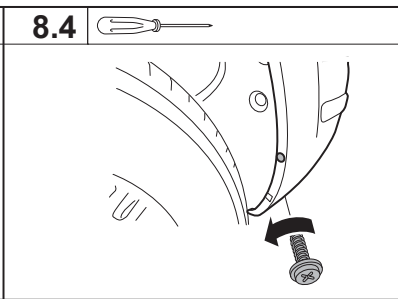
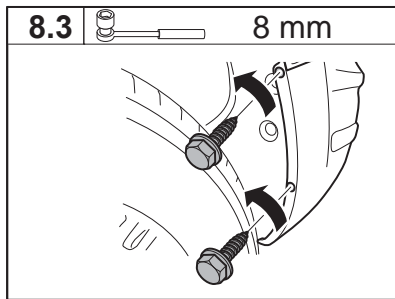
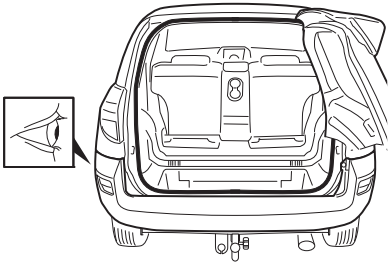
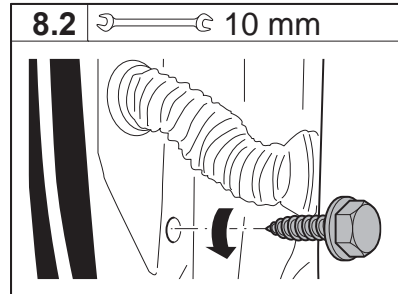
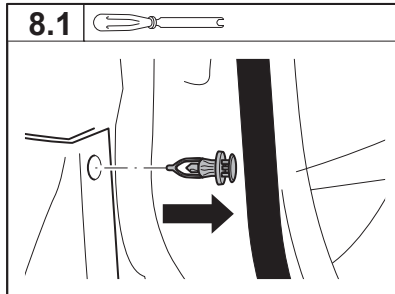
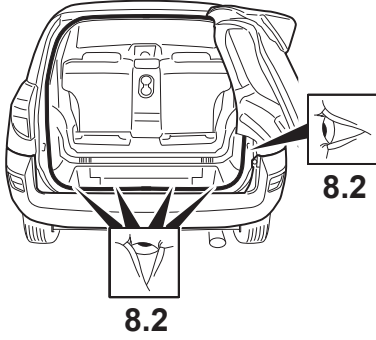
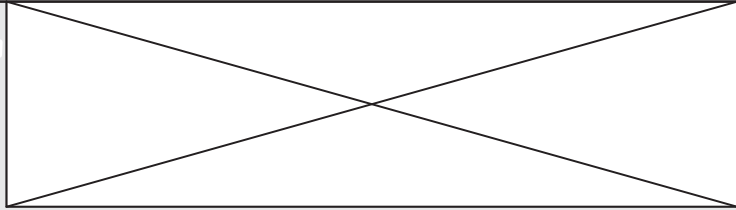
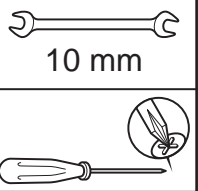
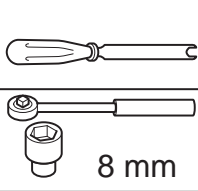

9



13 Pole



7 Pole

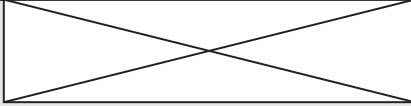

A

1x

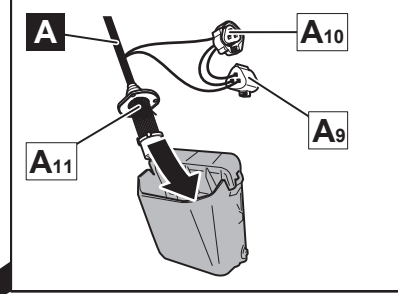
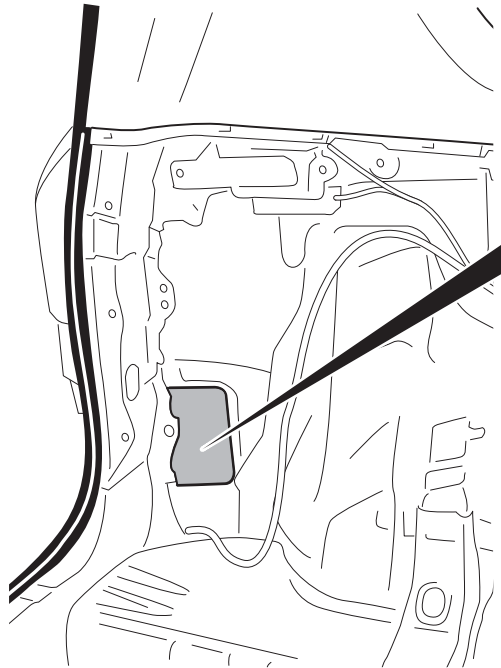
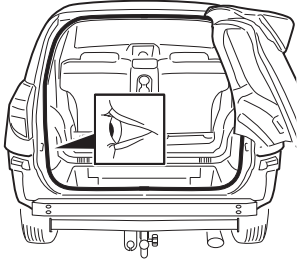
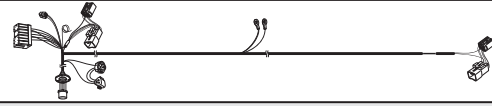

10



13 Pole



7 Pole

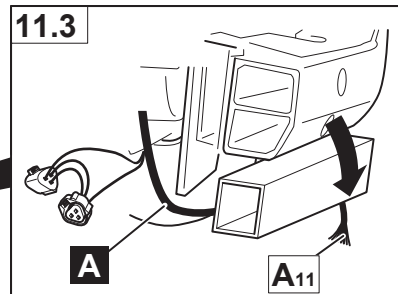
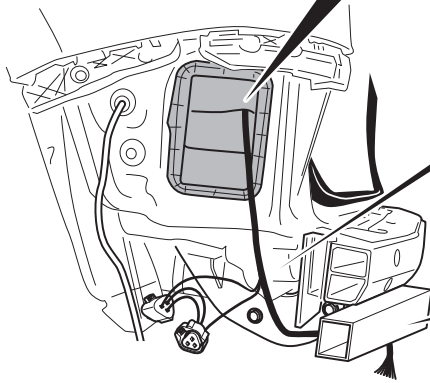
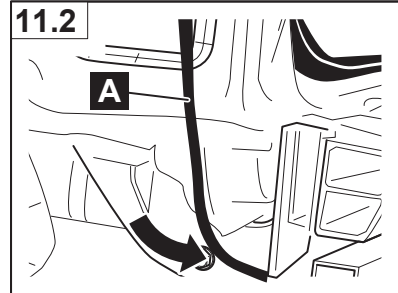
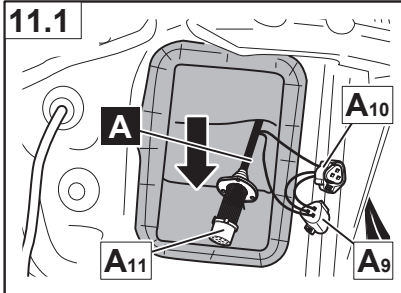
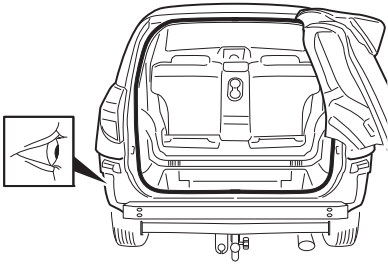
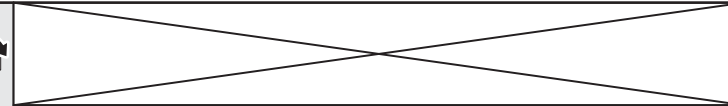
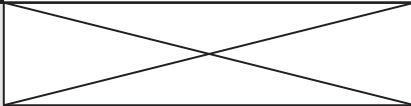

11



13 Pole



7 Pole

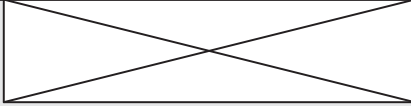

G

3x

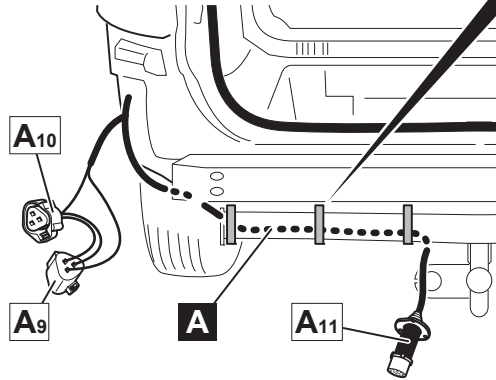
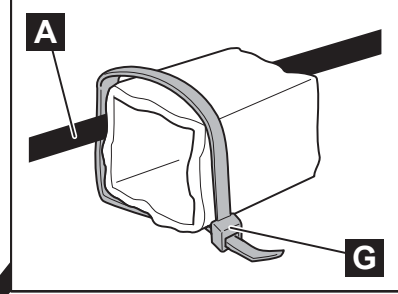
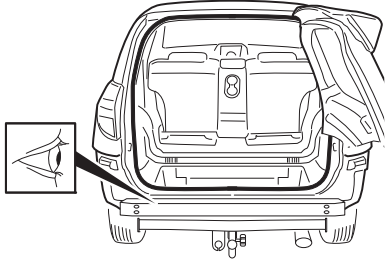

12



13 Pole



7 Pole

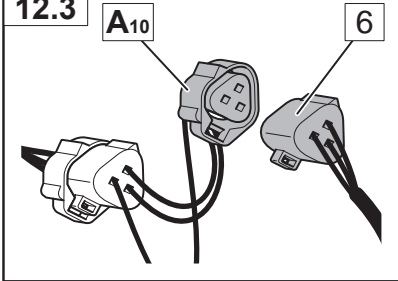
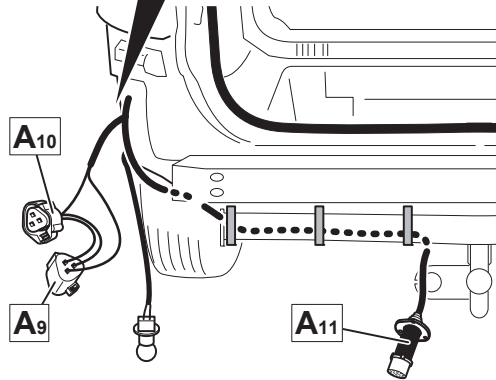
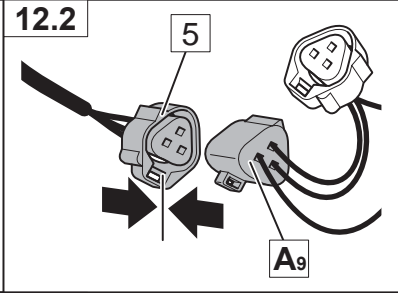
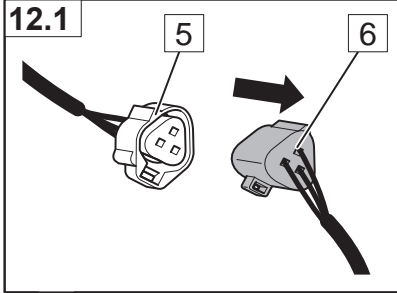
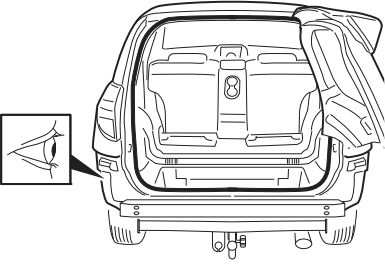
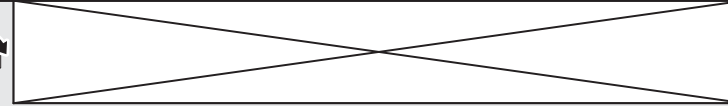
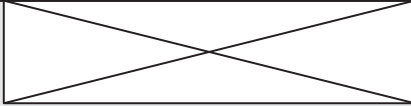

13



13 Pole



10 mm

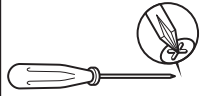

C

1x



E

3x

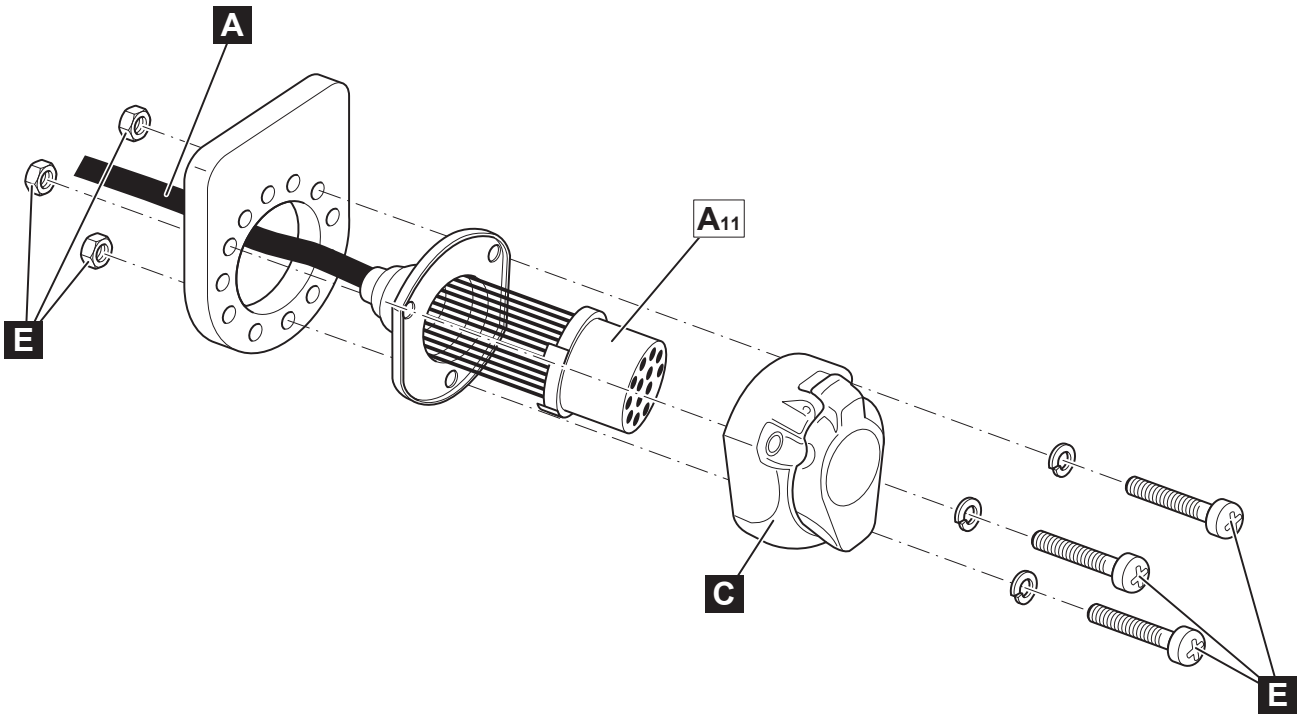

14



7 Pole

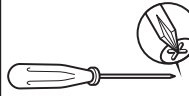
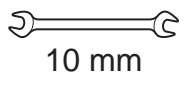

**B**

1x



**C**

1x

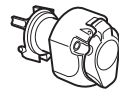

**E**

3x

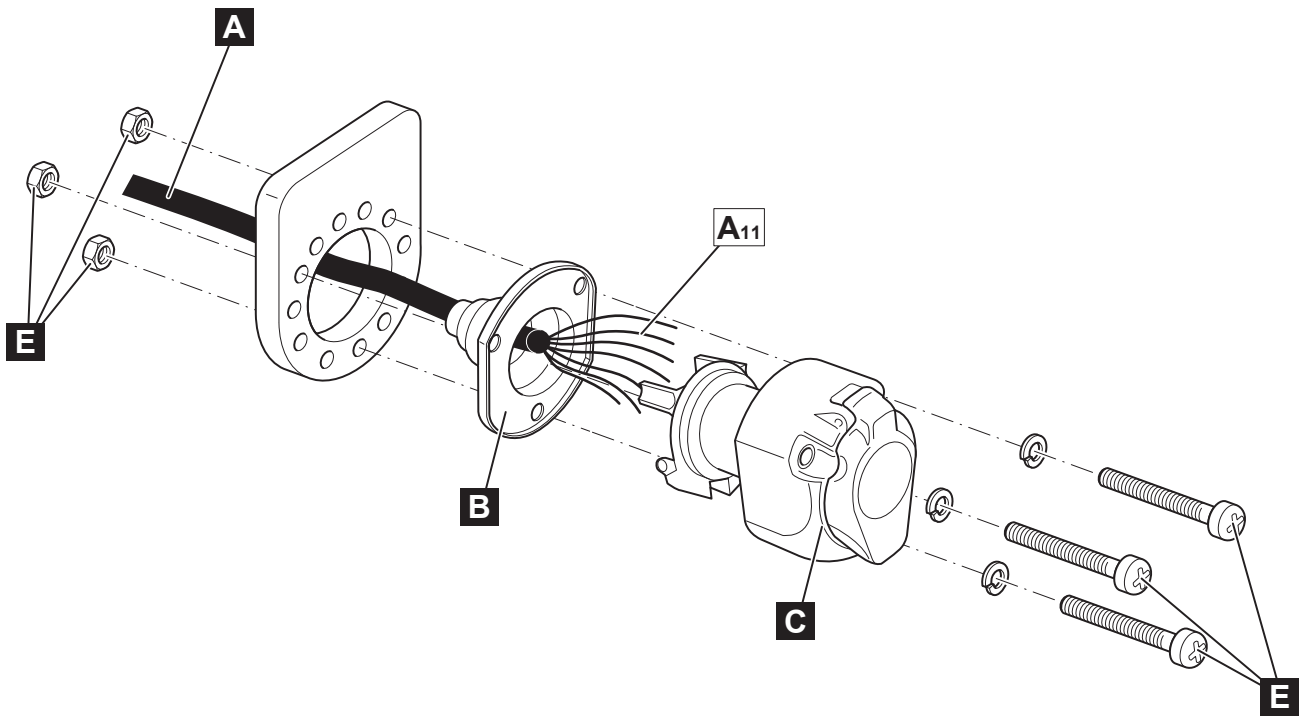

15



13 Pole



7 Pole

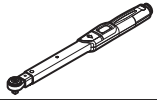

10 mm



D

1x

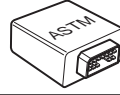

H

1x

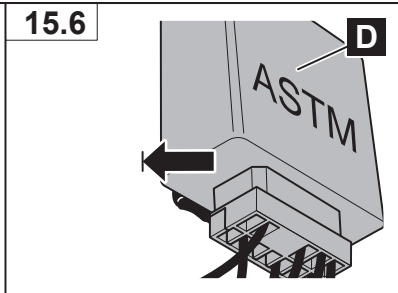
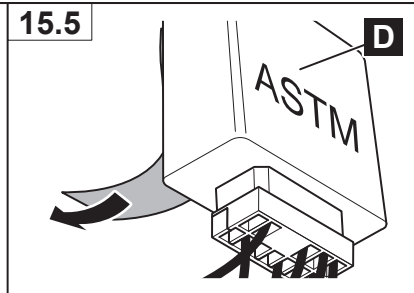
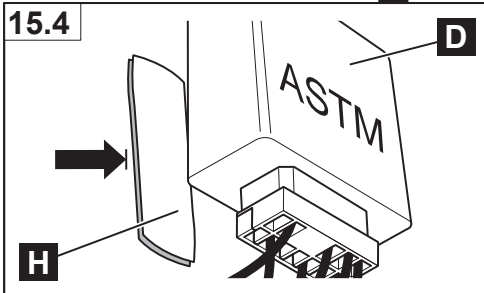
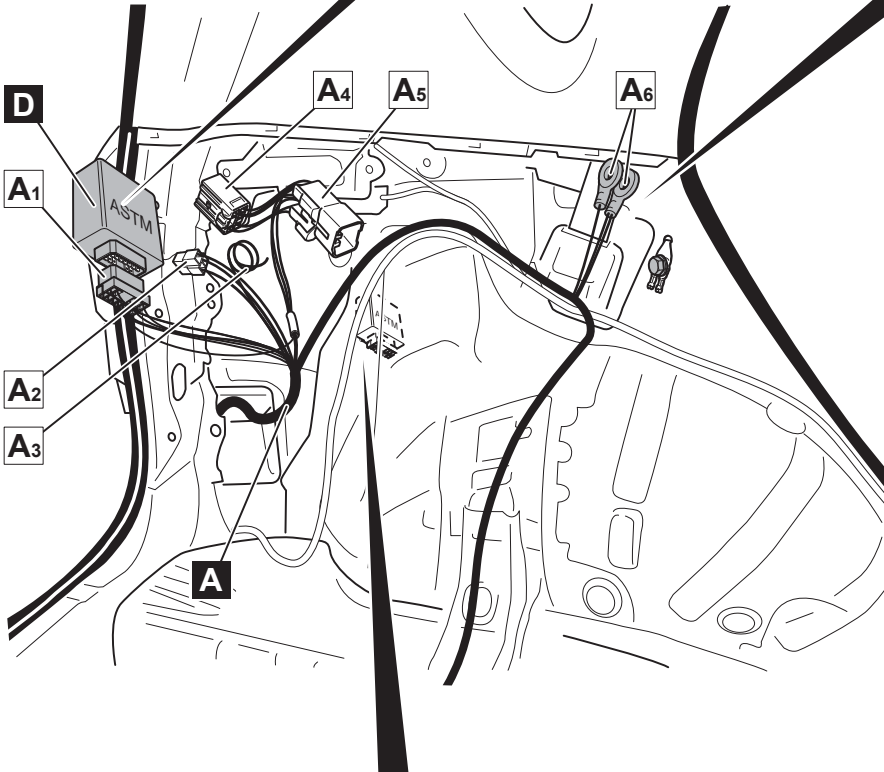
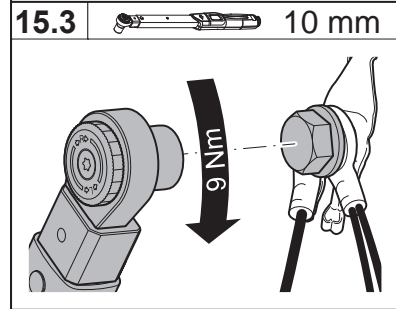
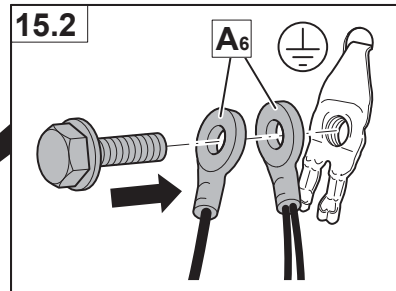
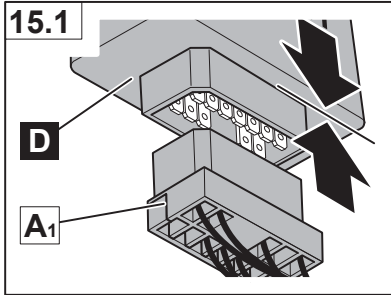
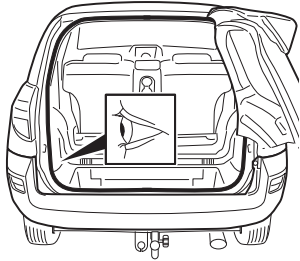

16



13 Pole



7 Pole

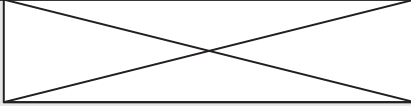

I

1x



F

7x

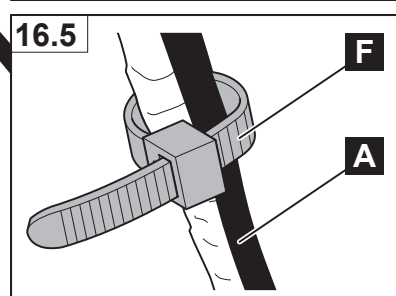
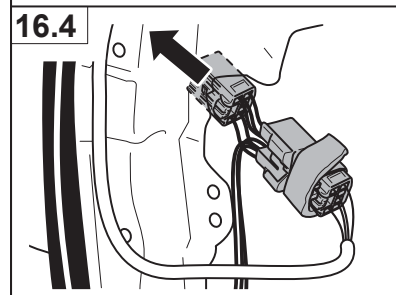
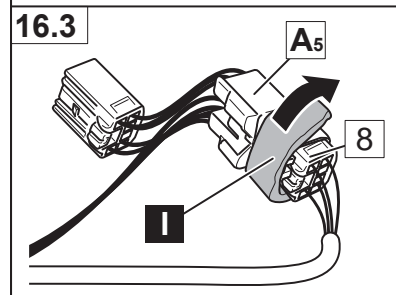
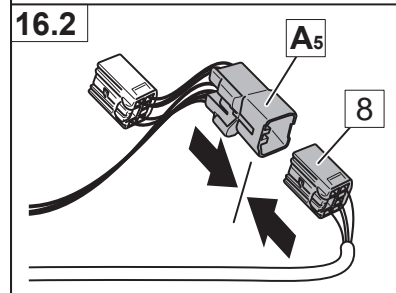
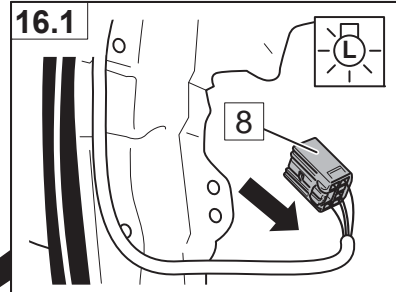
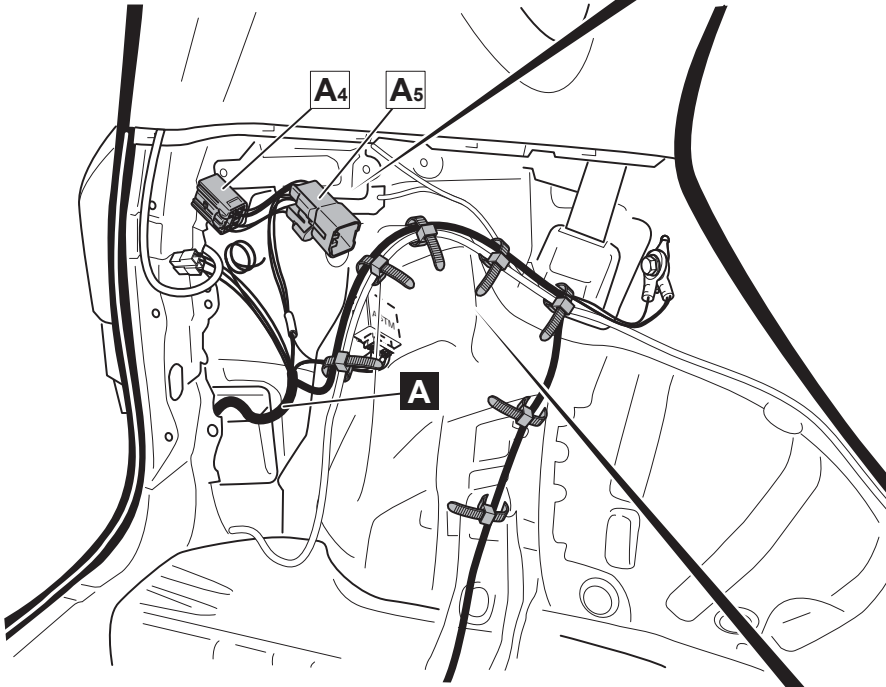
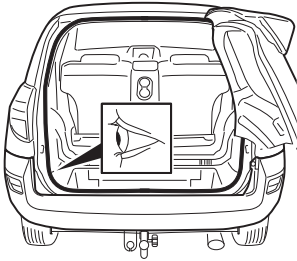
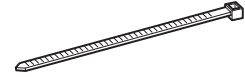



17



13 Pole



7 Pole

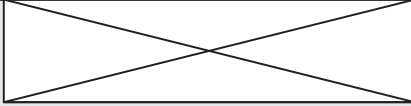

F

5x

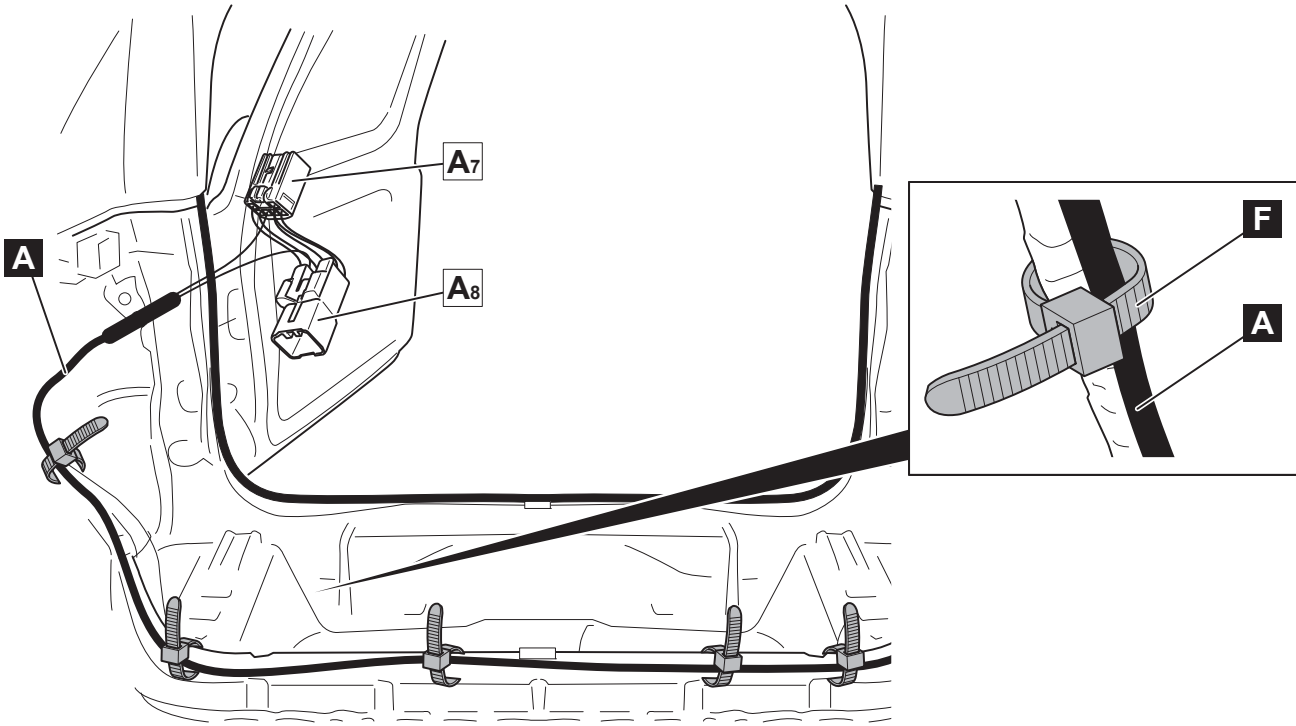
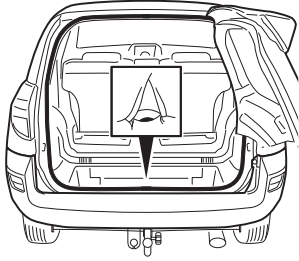
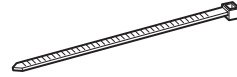

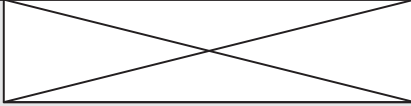

I  
1x

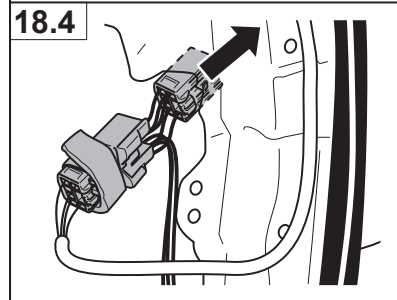
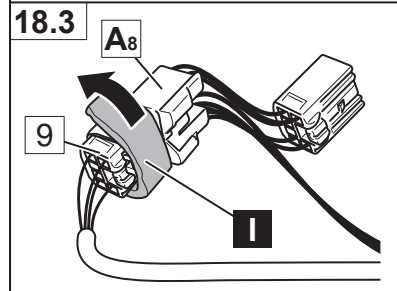
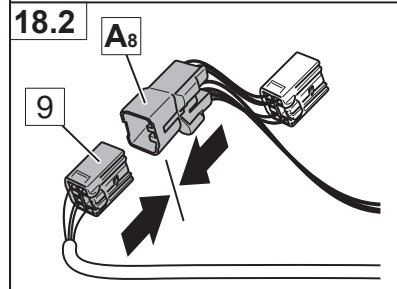
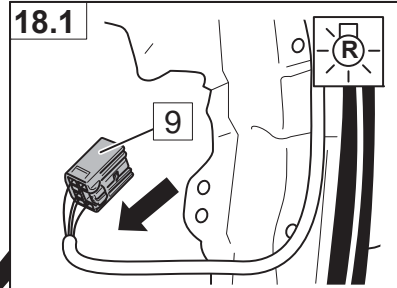
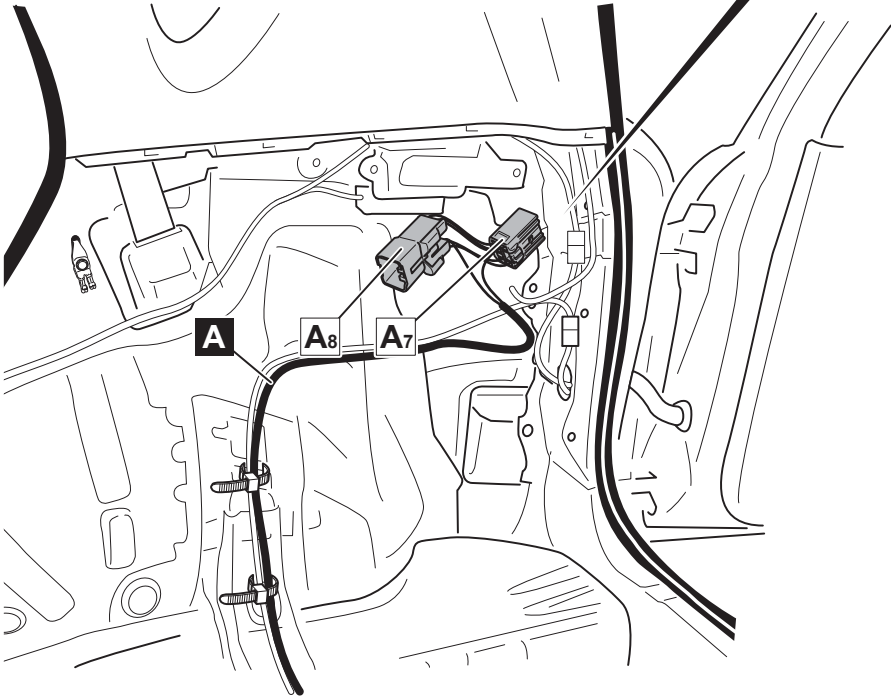
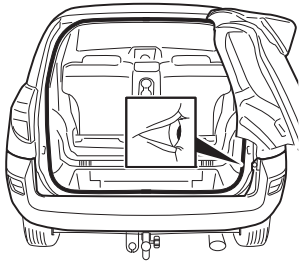

# 19

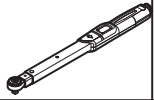

10 mm

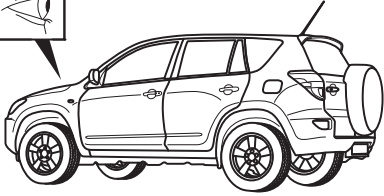
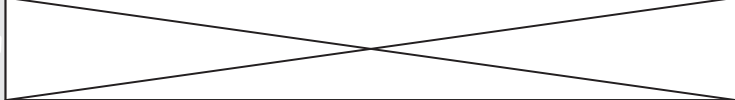

19.1

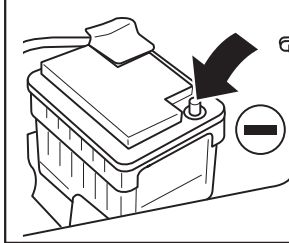

19.2

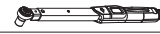

10 mm

