

55393

VS.

55883

48 RIBS EQ.SP.

47 RIBS EQ.SP.

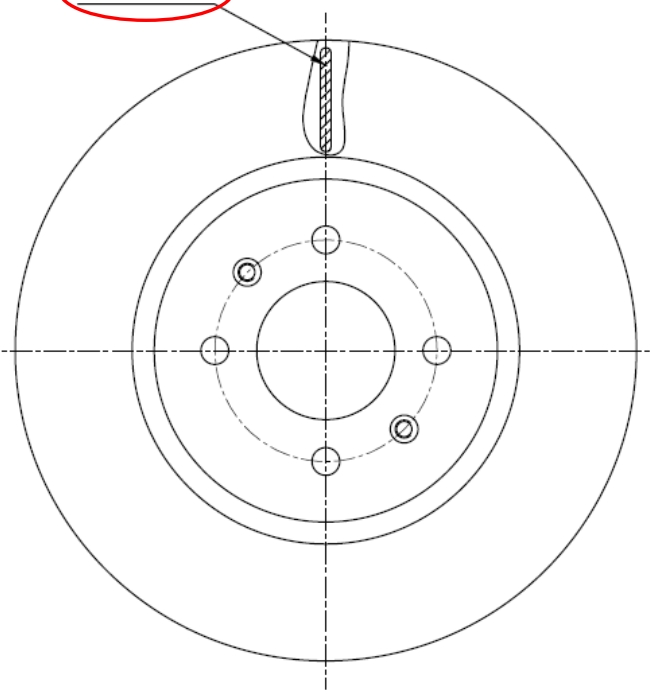
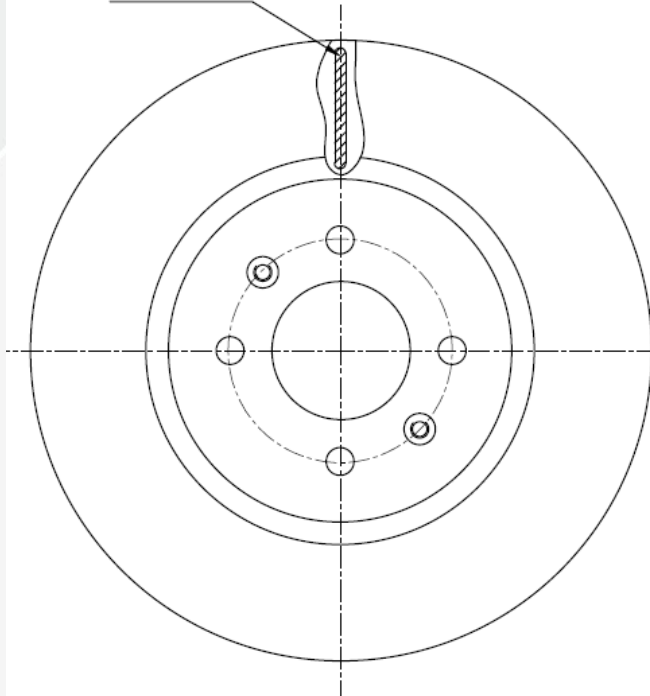

min.thickness 19.4

min.thickness 20.0