

MONTAGEANLEITUNG

ROTA LED COMPACT

INSTALLATION INSTRUCTION

ROTA LED COMPACT

INSTRUCTIONS DE MONTAGE

ROTA LED COMPACT

MONTERINGSANVISNING

ROTA LED COMPACT

MONTAGEHANDLEIDING

ROTA LED COMPACT

INSTRUCCIONES DE MONTAJE

ROTA LED COMPACT

ISTRUZIONI DI MONTAGGIO

ROTA LED COMPACT

ASENNUSOHJE

ROTA LED COMPACT

DE Technische Änderungen vorbehalten

EN Subject to alteration without notice

FR Sous réserve de modifications techniques

SV Vi reserverar oss för tekniska ändringar

NL Technische wijzigingen voorbehouden

ES Reservadas modificaciones técnicas

IT Con riserva di modifiche tecniche

FI Oikeus teknisiin muutoksiin pidätetään

Zeichenerklärung
Explanation symbols
Explication des symboles

Symbolförklaring
Legenda
Aclaración de símbolos

Legenda
Piirroksen selitys



- DE** Richtig
- EN** Correct
- FR** Correct
- SV** Rätt
- NL** Goed
- ES** Correcto
- IT** Giusto
- FI** Oikein



- DE** Falsch
- EN** Incorrect
- FR** Incorrect
- SV** Fel
- NL** Fout
- ES** Erróneo
- IT** Sbagliato
- FI** Väärin



- DE** Positionspfeil
- EN** Location/Position Arrow
- FR** Flèche de Position
- SV** Positionspil
- NL** Lokatie/Positie pijl
- ES** Flecha de posición
- IT** Freccia di posizione
- FI** Paikannusnuoli



- DE** Bewegungspfeil
- EN** Movement Arrow
- FR** Flèche indiquant sens du mouvement
- SV** Rörelsepil
- NL** Richtingspijl
- ES** Flecha de movimiento
- IT** Freccia di movimento
- FI** Liikesuuntanuoli



- DE** Achtung
- EN** Warning
- FR** Attention
- SV** Varning
- NL** Let op
- ES** Atención
- IT** Attenzione
- FI** Huomio



- DE** Abklemmen
- EN** Disconnect
- FR** Déconnecter
- SV** Koppla los
- NL** Demonteren
- ES** Desconectar
- IT** Staccare
- FI** Irrota



- DE** Verbinden
- EN** Connect
- FR** Connecter
- SV** Anslut
- NL** In elkaar
- ES** Conectar
- IT** Collegare
- FI** Yhdistä



- DE** Siehe
- EN** Look/See
- FR** Voir
- SV** Se
- NL** Kijkken naar
- ES** Ver
- IT** Vedere
- FI** Katso

Lieferumfang
Scope of delivery
Fourniture

Leveransomfattning
Leveringsomvang
Alcance de suministro

Contenuto della confezione
Toimituksen sisältö

A



2XD 013 979-001

B

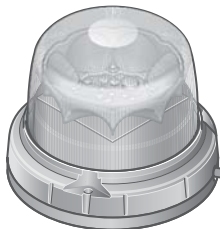

2XD 013 979-011

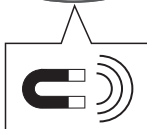

C

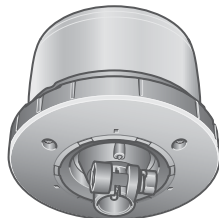

2XD 013 979-021

Zubehör
Accessories
Accessories

Tillbehör
Toebehoren
Accessorios

Accessori
Lisätarvikkeet

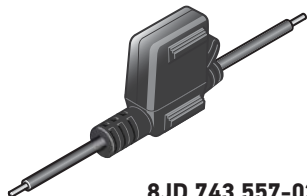

8JD 743 557-021



8KW 732 580-003



10A 8JS 711 686-821

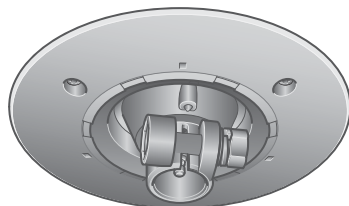

223 805-001

Benötigte Montagewerkzeuge
Installation tools required
Outillage de montage requis

Nödvändiga monteringsverktyg
Benodigde montagewerktuigen
Herramientas de montaje necesarias

Attrezzi necessari per il montaggio
Tarvittavat asennustyökalut

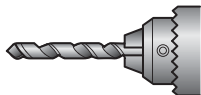

5 mm



CLEANER

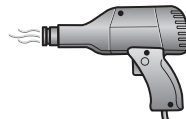
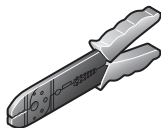

Montage
Mounting
Montage Général

Montering
Montage
Montaje

Montaggio
Asennus

A  **8, 9**



B  **10**

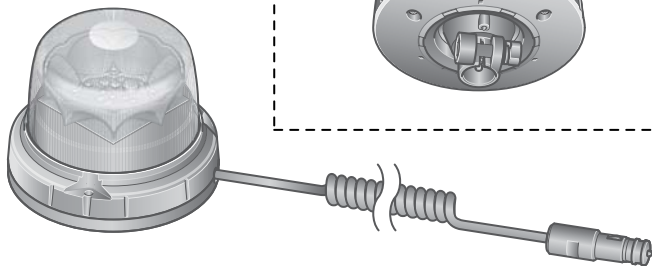

C  **11, 13**

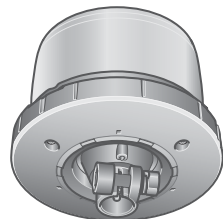

A

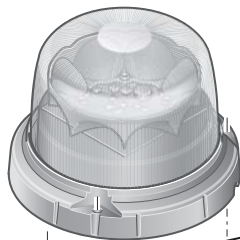
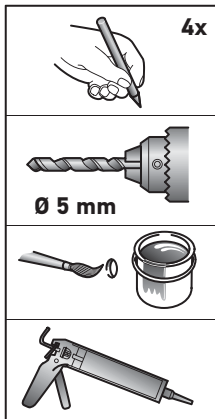
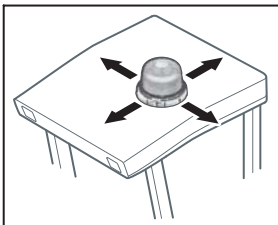

(-)
blau
blue
bleu
blå
blauw
azul
blu
sininen

(+)
rot
red
rouge
röd
rood
rojo
rosso
punainen



A

(+)
rot
red
rouge
röd
rood
rojo
rosso
punainen

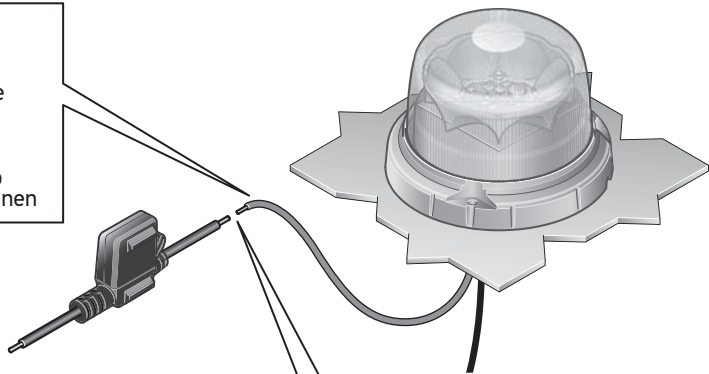

10mm

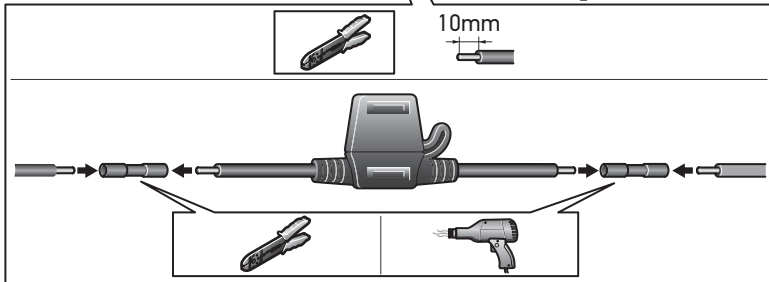

B $V_{max} = 120\text{km/h}$



CLEANER

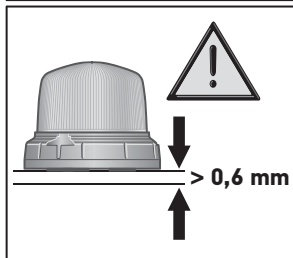
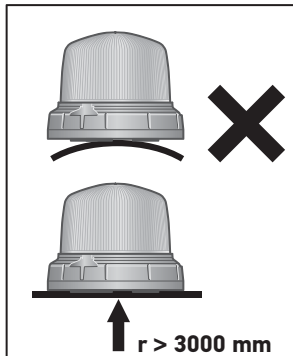
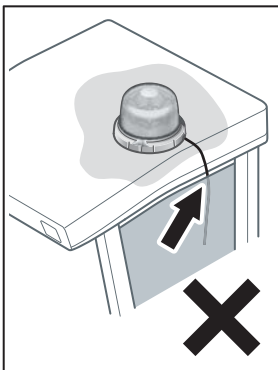
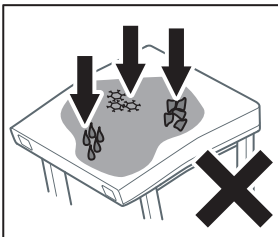
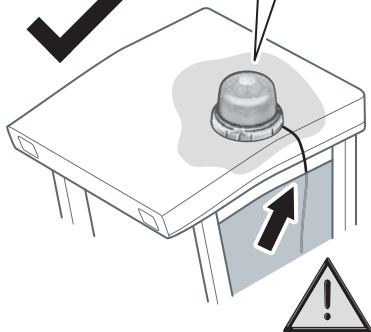

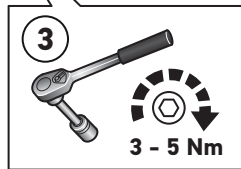
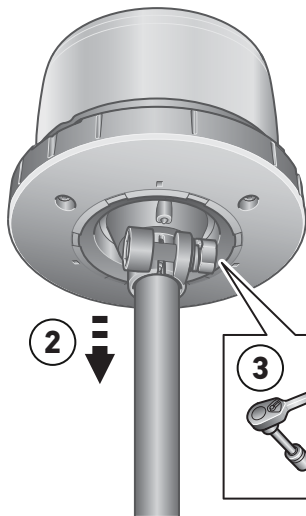
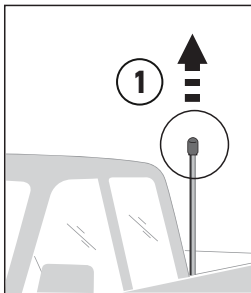
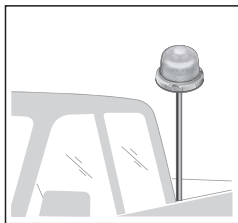
C

C

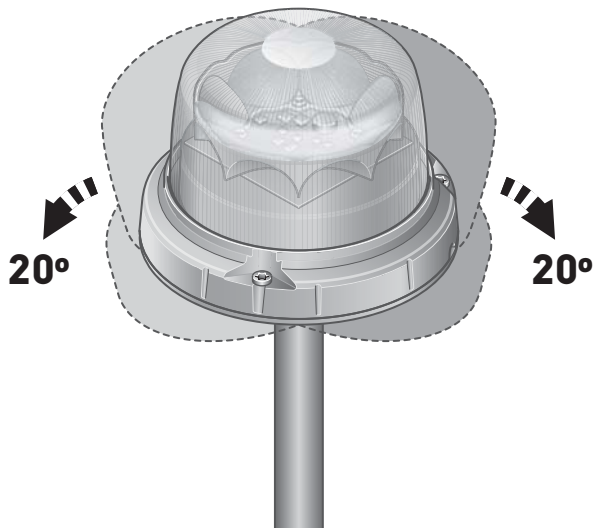
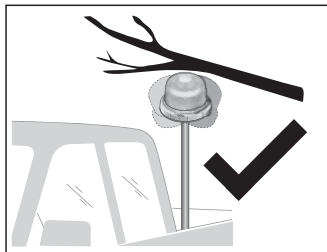

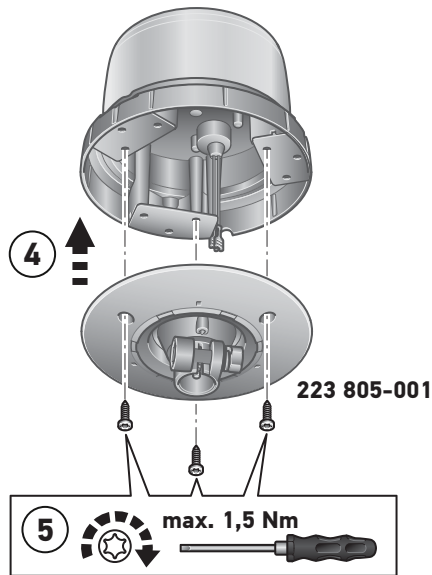
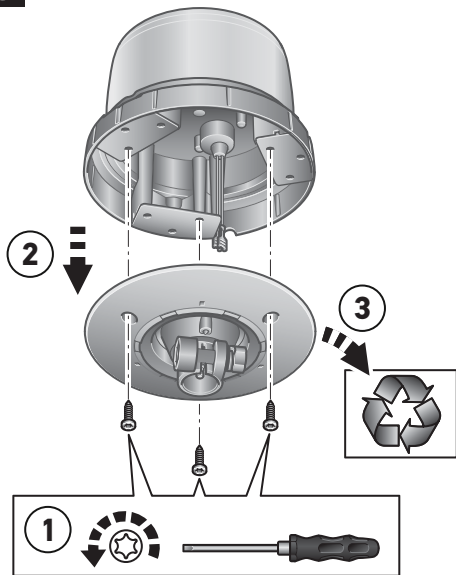
C

DE	Informationstext	15
EN	Information Text	16
FR	Texte d'information	17
SV	Informationstext	18
NL	Informatie tekst	19
ES	Texto informativo	20
IT	Informazioni	21
FI	Ohjetekstit	22

Einleitung:

Auf großen Flächen oder in engen Gassen, in der Halle oder im Außenbereich sind Flurförderfahrzeuge verschiedenster Art im Einsatz.

Ausführungen:

- Festanbau- Kennleuchte mit Anschlusslitzen und Unterlage.
- Magnetanbau- Kennleuchte mit Anschlusskabel und Stecker.
- DIN 14620 flexibler Rohrstützen für Rohr Montage.

Technische Daten

Typprüfung	Format: SAE-J845 Klasse 2 ECE-R65 TA1 E1 004636 ECE-R10 (E1) 10R - 058156
Gesamtstromaufnahme	10-30V: ca. 12 V - 0,8 A 24 V - 0,4 A
Entstörklasse	CISPR25 Klasse 5
Leistungsaufnahme	9-30V: ca. 10 W
Lichthaube	PC
Gebrauchslage	stehend
Schutzart	IP67, IPX9K
Temperaturbereich	minus 40 °C bis plus 60 °C
Verpolschutz	ja
Gehäuse	PC + ABS schwarz

Introduction:

Industrial trucks of highly varying types are in use in large areas and in close quarters, in halls as well as outdoor areas.

Versions:

- Permanently attached beacons with stranded connection wires and base.
- Magnetically attached beacons with connection cable and plug.
- DIN 14620 a flexible pipe connection for pipe mounting.

Technical Data

Type approval:	Format: SAE-J845 Class 2 ECE-R65 TA1 E1 004636 ECE-R10 (E1) 10R - 058156
Total current consumption	10-30V: approx. 12 V - 0,8 A 24 V - 0,4 A
Interference suppression class	CISPR25 Class 5
Power consumption	9-30V: approx. 10 W
Dome	PC
Operating position	Upright
Protective rating	IP67, IPX9K
Temperature range	minus 40 °C to plus 60 °C
Inverse polarity protection	yes
Housing	PC + ABS black

Introduction :

Toutes sortes d'engins de manutention sont utilisés dans toutes sortes d'endroits : sur de vastes espaces, dans des allées étroites, dans des hangars, à l'extérieur.

Conceptions :

- Feu rotatif à montage fixe avec torons de raccordement et support.
- Feu rotatif à fixation magnétique avec câble de connexion et connecteur.
- DIN 14620 une tubulure flexibles pour installation de conduites.

Caractéristiques techniques

Homologation:	Format: SAE-J845 Classe 2 ECE-R65 TA1 E1 004636 ECE-R10 (E1) 10R - 058156
Courant total absorbé	10-30V: env. 12 V - 0,8 A 24 V - 0,4 A
Classe de déparasitage	CISPR25 Classe 5
Puissance absorbée	9-30V: env. 10 W
Cabochon	PC
Position d'utilisation	debout
Indice de protection	IP67, IPX9K
Plage de température	moins 40 °C à plus 60 °C
Protection contre les inversions de polarité	oui
Boîtier	PC + ABS noir

Inledning:

På öppna ytor eller i trånga gränder, i hallar eller utomhus används industritruckar av olika slag.

Utföranden:

- Varningsfyr för fast montering med anslutningsslits och underlägg.
- Varningsfyr för montering med magnet med anslutningskabel och kontakt.
- DIN 14620 prilagodljivo vtičnice cevi za namestitev cevi.

Tekniska data

Typprovning:	Format: SAE-J845 Klass 2 ECE-R65 TA1 E1 004636 ECE-R10 (E1) 10R - 058156
Total strömupptagning	10-30V: ca. 12 V - 0,8 A 24 V - 0,4 A
Avstörningsklass	CISPR25 Klass 5
Effektförbrukning	9-30V: ca. 10 W
Ljushuv	PC
Användningsläge	Stående
Kapslingstyp	IP67, IPX9K
Temperaturområde	minus 40 °C till plus 60 °C
Polomkastnings-skydd	ja
Hus	PC + ABS svart

Inleiding:

In grote ruimtes of smalle steegjes, in de loods of buiten: overal zijn de meest uiteenlopende transportvoertuigen in gebruik.

Uitvoeringen:

- Zwaailicht voor vaste montage met aansluitkabel en onderplaat.
- Zwaailicht met magneetbevestiging met aansluitkabel en stekker.
- DIN 14620 een flexibele buis aansluitingen voor leidingen installeren.

Technische gegevens

Typekeuring	Format: SAE-J845 Klasse 2 ECE-R65 TA1 E1 004636 ECE-R10 (E1) 10R - 058156
Totale stroomverbruik	10-30V: ca. 12 V - 0,8 A 24 V - 0,4 A
Ontstoringsklasse	CISPR25 Klasse 5
Vermogensopname	9-30V: ca. 10 W
Lichtkap	PC
Toepassingsstand	staand
Beschermsoort	IP67, IPX9K
Temperatuurbereik	min 40 °C tot plus 60 °C
Poolinversie-beveiliging	ja
Behuizing	PC + ABS zwart

Introducción:

En grandes superficies o en calles estrechas, dentro de naves industriales o en el exterior se utilizan vehículos industriales de distintos tipos.

Versiones:

- Luz de señalización para montaje fijo con cables de conexión y base.
- Luz de señalización para montaje magnético con cable de conexión y conector.
- DIN 14620 a racores tubulares flexibles para la instalación de tuberías.

Datos técnicos

Formato de la homologación de tipo:	Format: SAE-J845 Clase 2 ECE-R65 TA1 E1 004636 ECE-R10 (E1) 10R - 058156
Consumo de corriente total	10-30V: aprox. 12 V - 0,8 A 24 V - 0,4 A
Clase de supr. de interf.	CISPR25 Clase 5
Consumo de potencia	9-30V: aprox. 10 W
Cubierta	PC
Posición de empleo	de pie
Tipo de protección	IP67, IPX9K
Intervalo de temperatura	- 40 °C a + 60 °C
Protección ante inv. de polaridad	sí
Carcasa	PC + ABS negro

Introduzione:

In spazi ampi o in spazi stretti, al coperto o all'aperto: i veicoli trasporto interno utilizzati sono di tipo diverso.

Versioni:

- Girevole per montaggio fisso con cavetti di collegamento e base.
- Girevole per montaggio con magneti con cavetti di collegamento e connettori.
- DIN 14620 un raccordo tubo flessibile per il montaggio tubo.

Dati tecnici

Omologazione:	Format: SAE-J845 Classe 2 ECE-R65 TA1 E1 004636 ECE-R10 (E1) 10R - 058156
Assorbimento complessivo di corrente	10-30V: ca. 12 V - 0,8 A 24 V - 0,4 A
Classe di soppressione delle interferenze	CISPR25 Classe 5
Potenza assorbita	9-30V: ca. 10W
Calotta	PC
Posizione d'impiego	Eretta
Classi di protezione	IP67, IPX9K
Intervallo di temperatura	Da meno 40 °C a più 60 °C
Protezione contro l'inversione della polarità	Sì
Alloggiamento	PC + ABS nero

Johdanto:

Suurilla alueilla tai ahtaissa paikoissa, hallissa tai ulkoalueella käytetään erilaisia kuljetusajoneuvoja.

Mallit:

- Kiinteästi asennettava tunnistusvalolamppu jossa on liitäntäjohtimet ja alusta.
- Magneettikiinnitteinen tunnistusvalolamppu jossa on liitäntäkaapeli ja pistoke.
- DIN 14620 joustava putkiliitäntä putkiasennukseen.

Tekniset tiedot

Tyyppihyväksyntä, muoto:	Format: SAE-J845 Klasse 2 ECE-R65 TA1 E1 004636 ECE-R10 (E1) 10R - 058156
Kokonaisvirrankulutus	10-30V: noin 12 V - 0,8 A 24 V - 0,4 A
EMC-radionäkösuojaluokka	CISPR25 Luokka 5
Tehonotto	9-30V: noin 10 W
Koppa	PC
Käyttöasento	pystyasento
Suojaluokka	IP67, IPX9K
Lämpötila-alue	-40 °C - +60 °C
Navoitussuoja	kyllä
Kotelo	PC + ABS musta

DE Beleuchtungsanlage auf einwandfreie Funktion hin prüfen

EN Check that the lighting system is working perfectly

FR Contrôler le bon fonctionnement de l'installation d'éclairage

SV Kontrollera att ljussystemet fungerar felritt

NL Controleer of de verlichting goed functioneert

ES Comprobar que el sistema de iluminación funciona impecablemente

IT Controllare la perfetta funzionalità dell'impianto di illuminazione

FI Tarkasta valaistusjärjestelmän toiminta

DE Bei Fragen oder Einbauproblemen, rufen Sie bitte den HELLA Kundendienst, Großhändler an oder wenden Sie sich an Ihre Werkstatt.

EN If you have questions or installation problems, please call the HELLA Service, wholesaler, or turn to your garage.

FR Pour toutes questions ou problèmes de montage, merci de contacter le service après-vente HELLA, votre distributeur ou votre garage.

SV Vid frågor eller monteringsproblem, kontakta Hellas kundtjänst, återförsäljaren eller din verkstad.

NL In geval van vragen of montageproblemen verzoeken wij u contact met de HELLA-klantenservice, de groothandel of uw dealer op te nemen.

ES En caso de dudas o problemas de montaje, por favor, llame al Servicio postventa de Hella o al mayorista, o bien diríjase a su taller.

IT Per qualsiasi domanda o problemi di montaggio si prega di contattare il servizio assistenza o il proprio grossista HELLA oppure di rivolgersi alla propria officina.

FI Jos sinulla on kysymyksiä tai asennusongelmia, soita HELLA-asiakaspalvelulle tai tukkuliikkeelle tai käänny korjaamon puoleen.

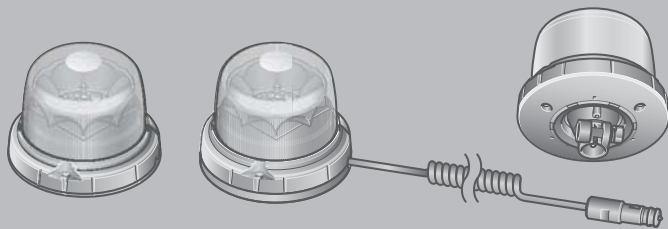

HELLA KGaA Hueck & Co.

Rixbecker Straße 75

59552 Lippstadt /Germany

www.hella.com

© HELLA KGaA Hueck & Co., Lippstadt
460 909-42 /04.17